

Lockpick

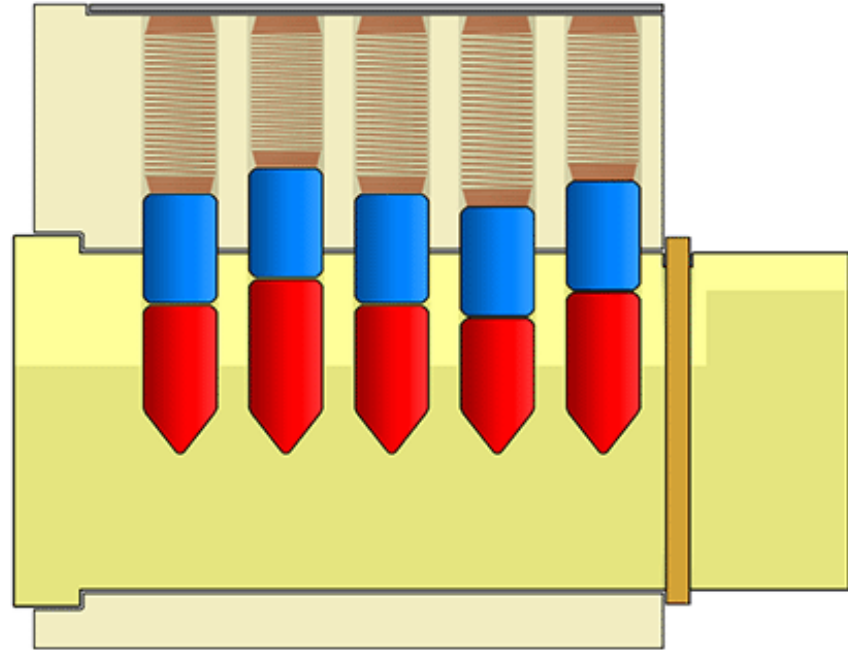

Pins

Wafer

S

Combo

Resis

tant

Bumpi

ng

Impre

ssion

Maste

ring

TOOL

Why do Locks Matter ?

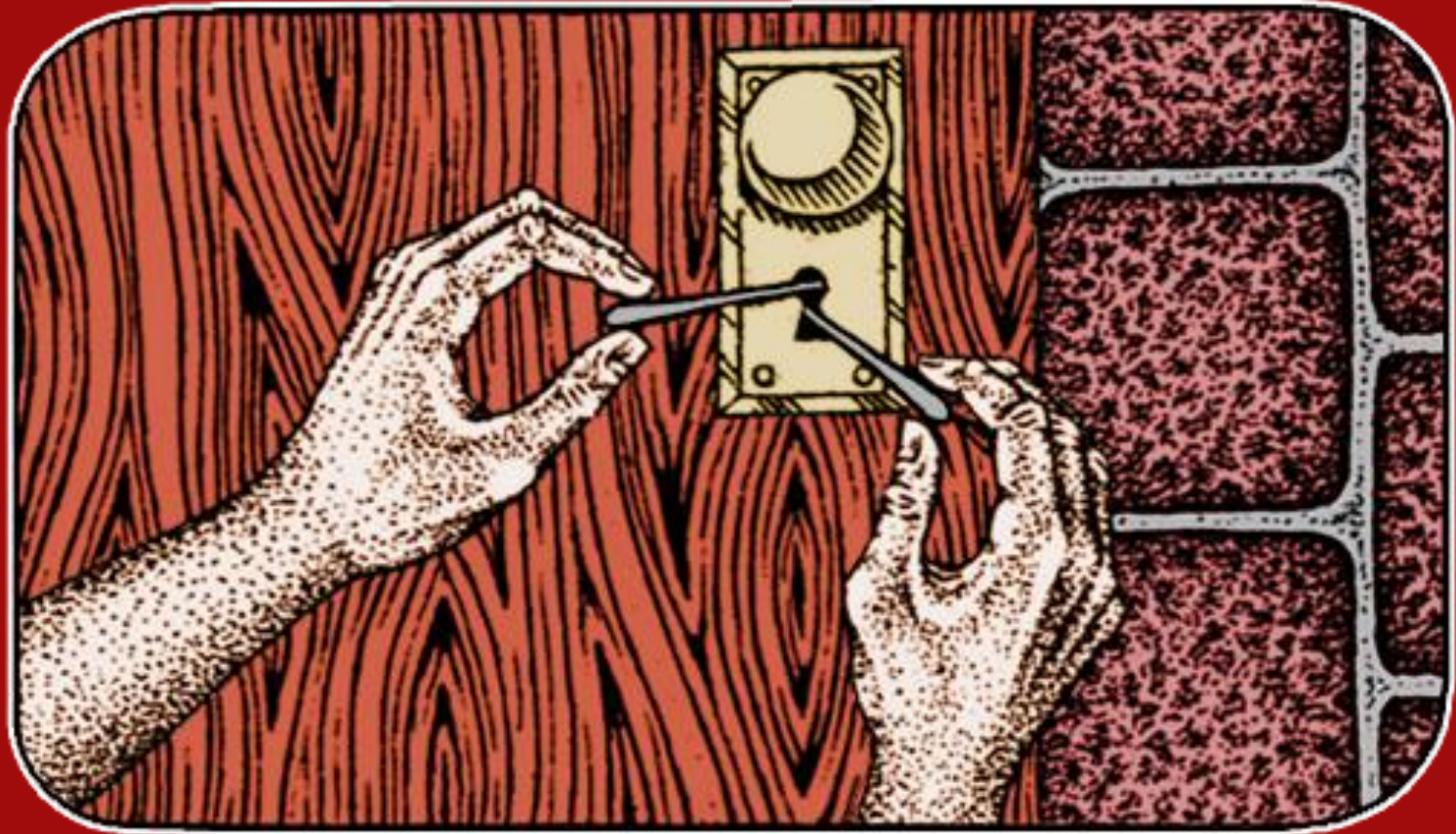

Locks Hold a Special Place in Our Lives



Locks Hold a Special Place in Our Lives



Locks Hold a Special Place in Our Lives



Locks Hold a Special Place in Our Lives



“What Does a Lock Signify?”

(Schu



“What Does a Lock Signify?”

(Schu



Puzzles



Puzzles



Puzzles

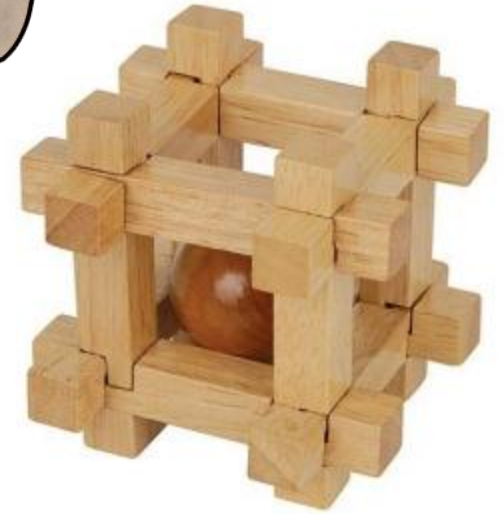

Lockpicking is fun puzzle solving for us



Try your hand at Lockpicking

Games



... Win Fabulous Prizes and Become Famous!



The Competition Can Get Serious



Intro to Lockpicking

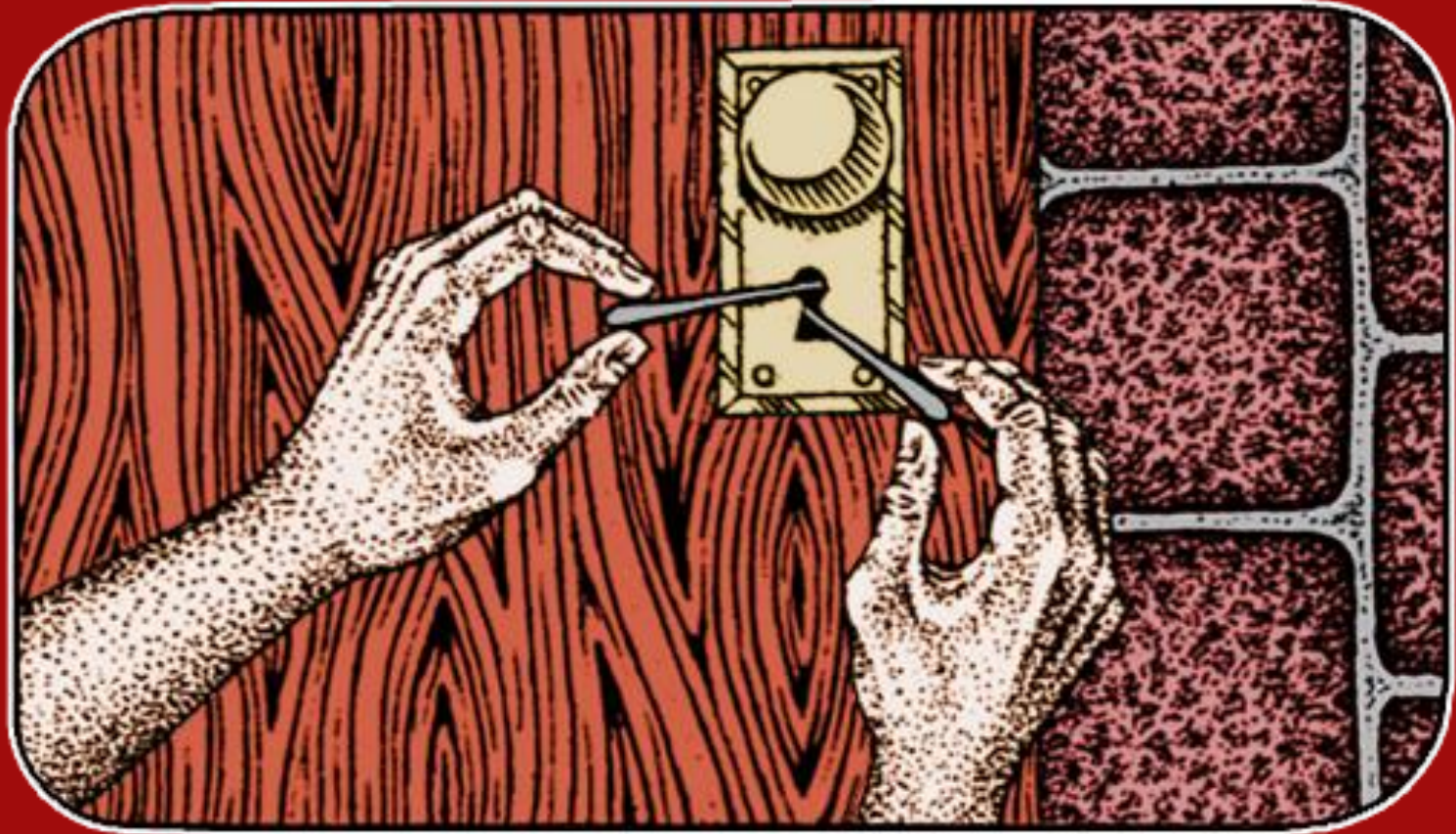

First, a word about rules..

Yes, we have rules. 😊

1. Do not pick locks
which you do not own.

2. Do not pick locks upon
which you rely.

The Three Kinds of Lock-Opening



The Three Kinds of Lock-Opening

1. Lockpicking

The Three Kinds of Lock-Opening

1. Lockpicking

2. Quick & Dirty

The Three Kinds of Lock-Opening

1. Lockpicking

2. Quick & Dirty

The Three Kinds of Lock-Opening

1. Lockpicking - what we do

2. Quick & Dirty

The Three Kinds of Lock-Opening

1. Lockpicking - what we do

2. Quick & Dirty - what criminals do

The Three Kinds of Lock-Opening

1. Lockpicking - what we do

2. Quick & Dirty - what criminals do

The Three Kinds of Lock-Opening

1. Lockpicking - what we do

TOOOL provides the knowledge and the means

2. Quick & Dirty - what criminals do

TOOOL provides knowledge. . . but no means

Lockpicking is Easy!



Pin Tumbler Locks



Pin Tumbler Locks



Pin Tumbler Locks



Outer View

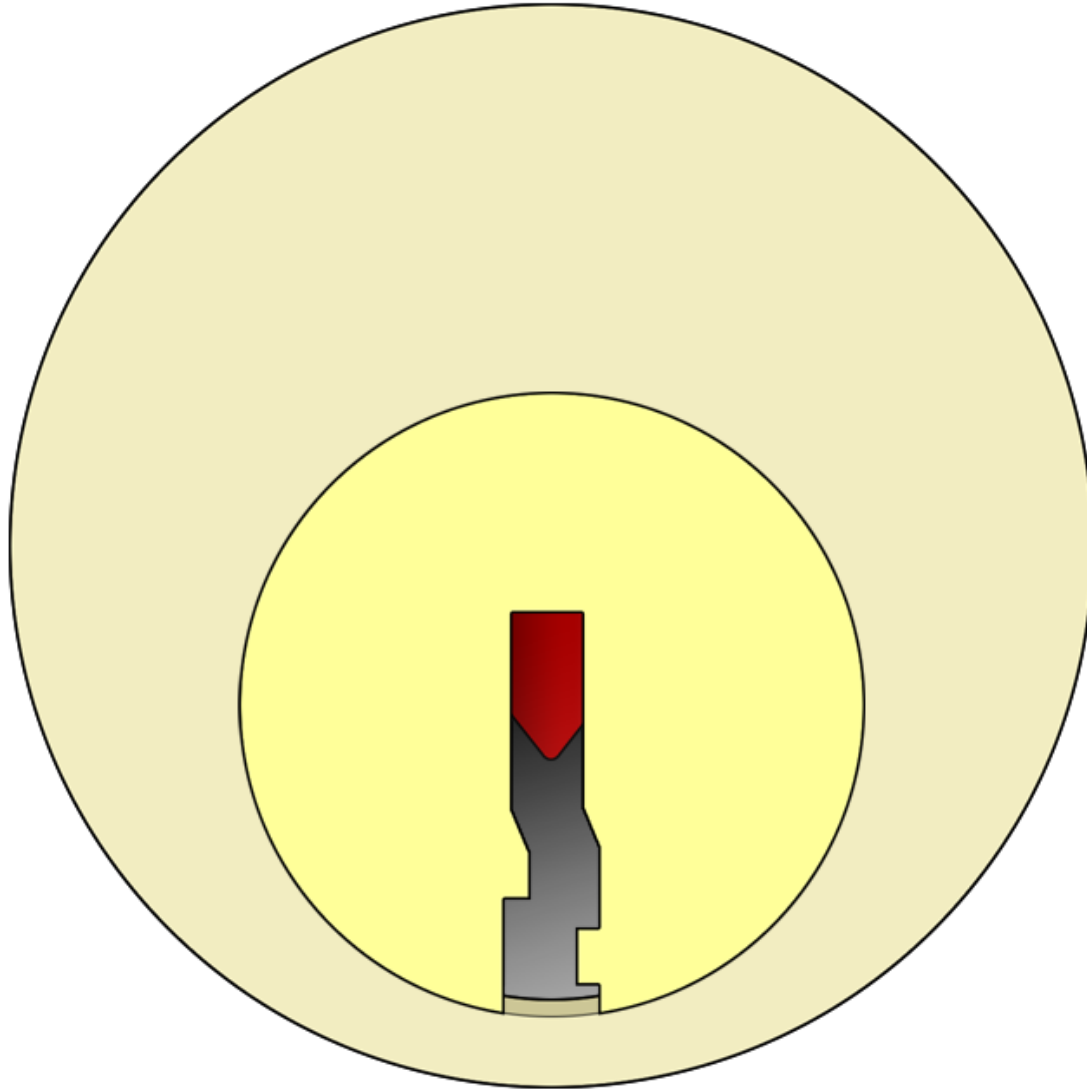

Inner View

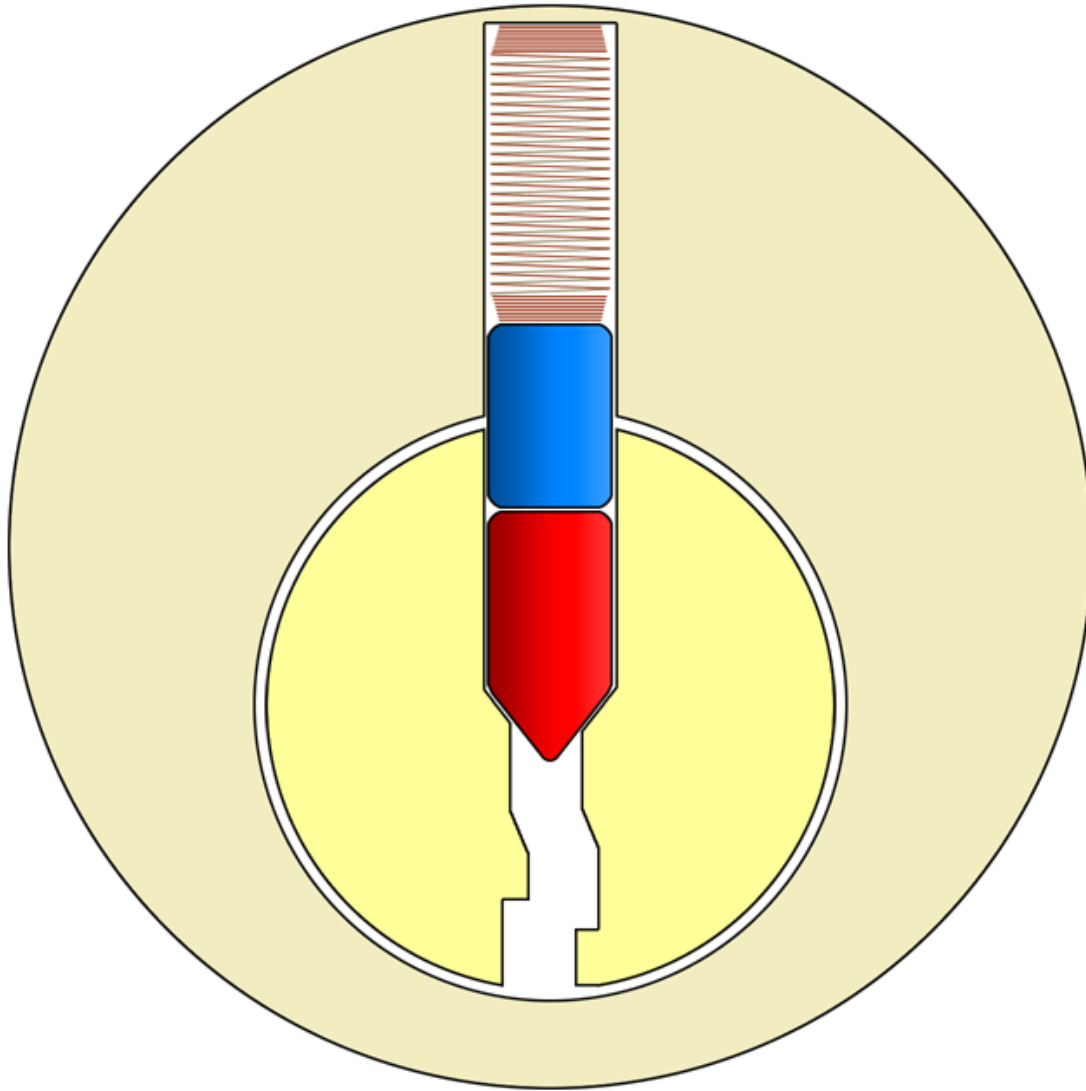

Attempt Without a Key

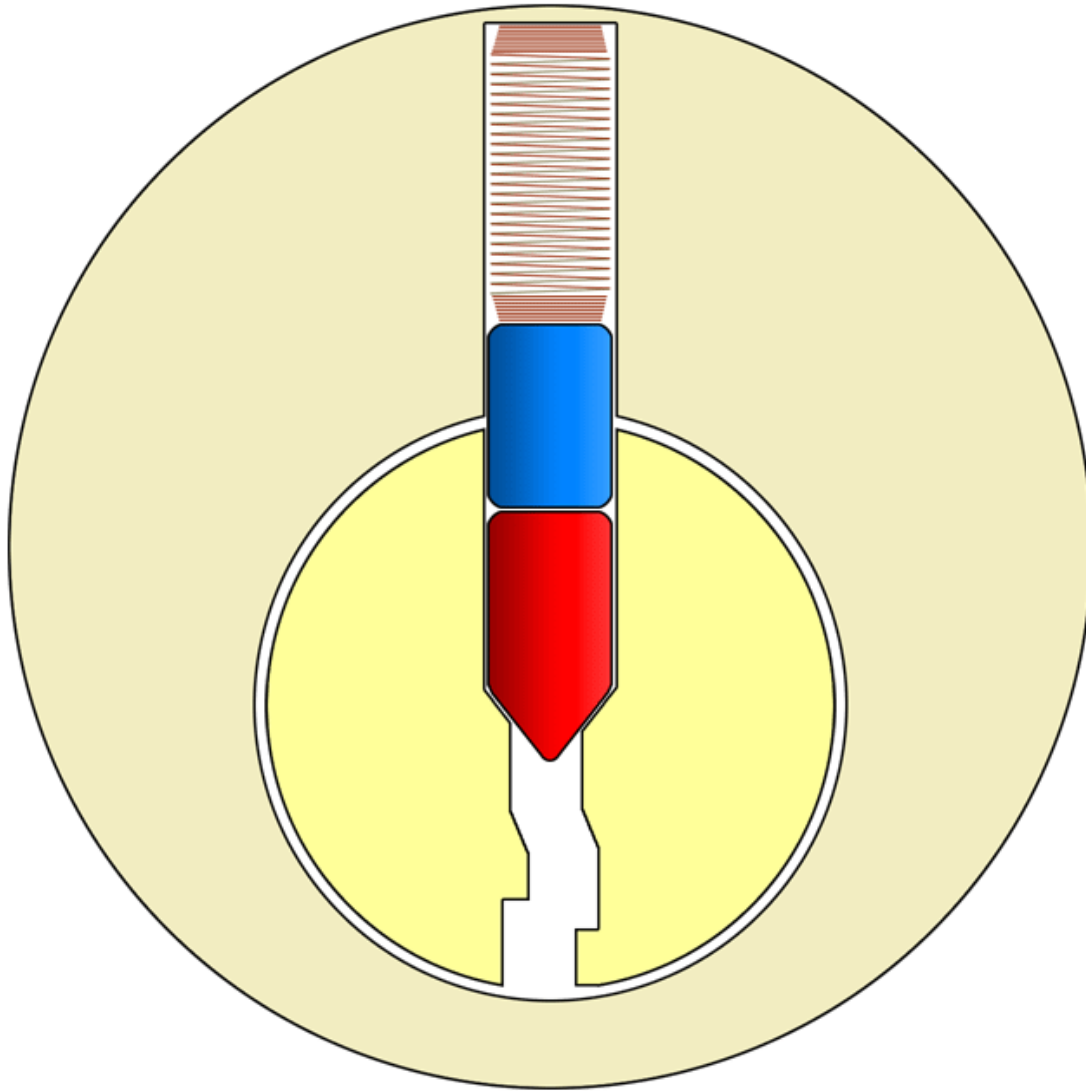

Operating With a Key

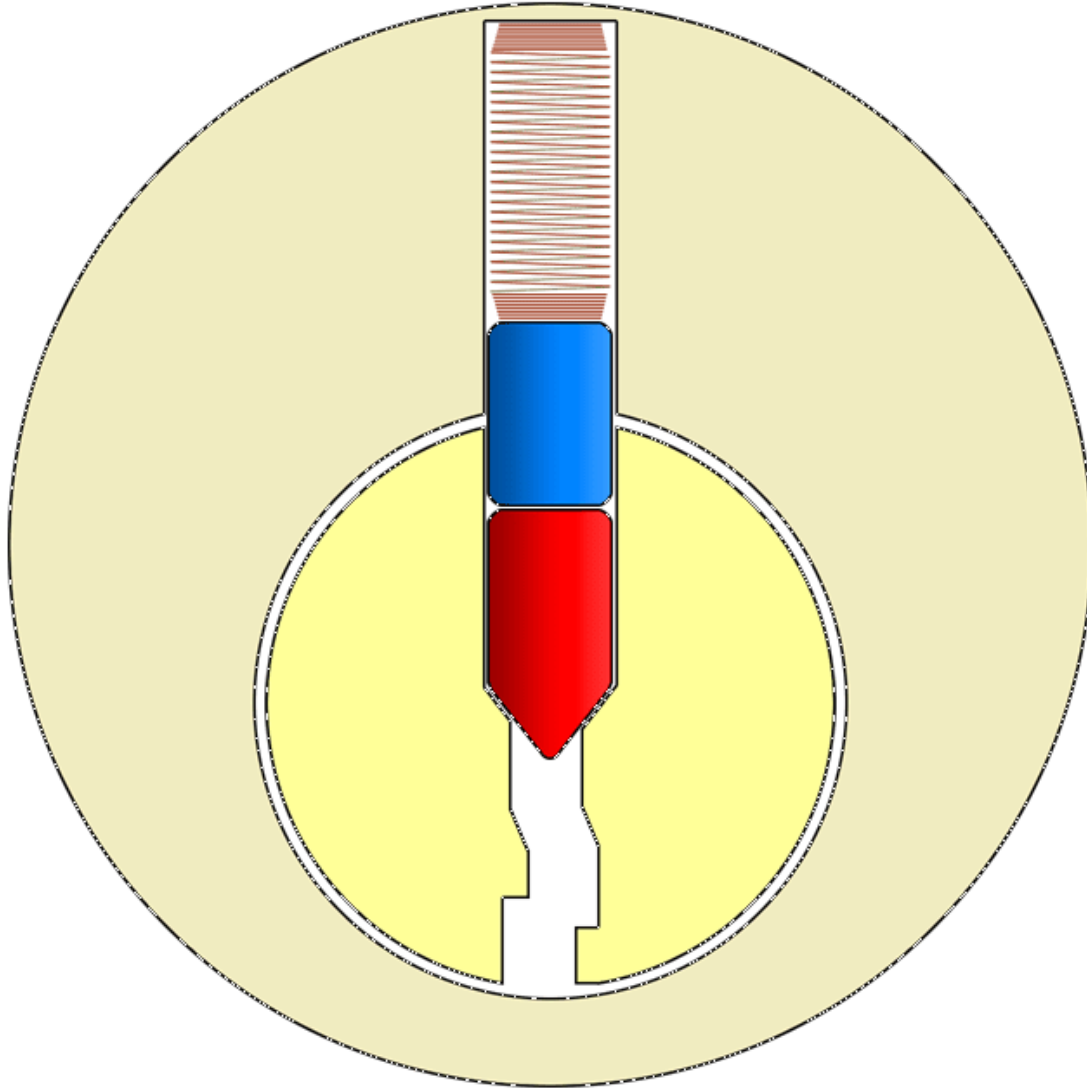

Pin Stacks

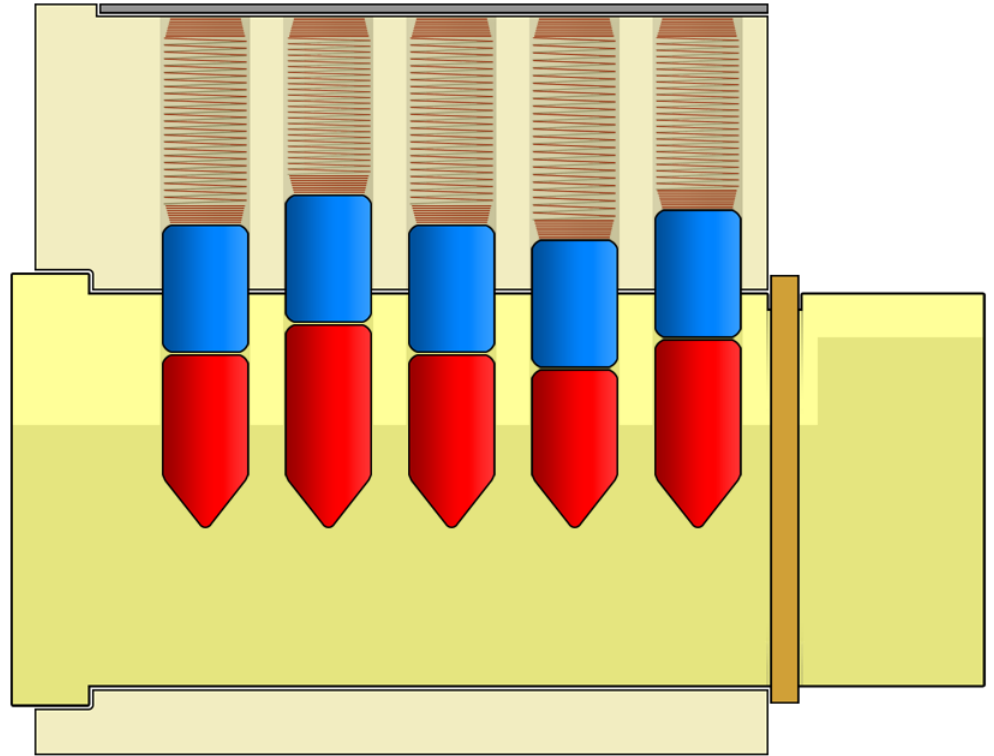

Key Operation

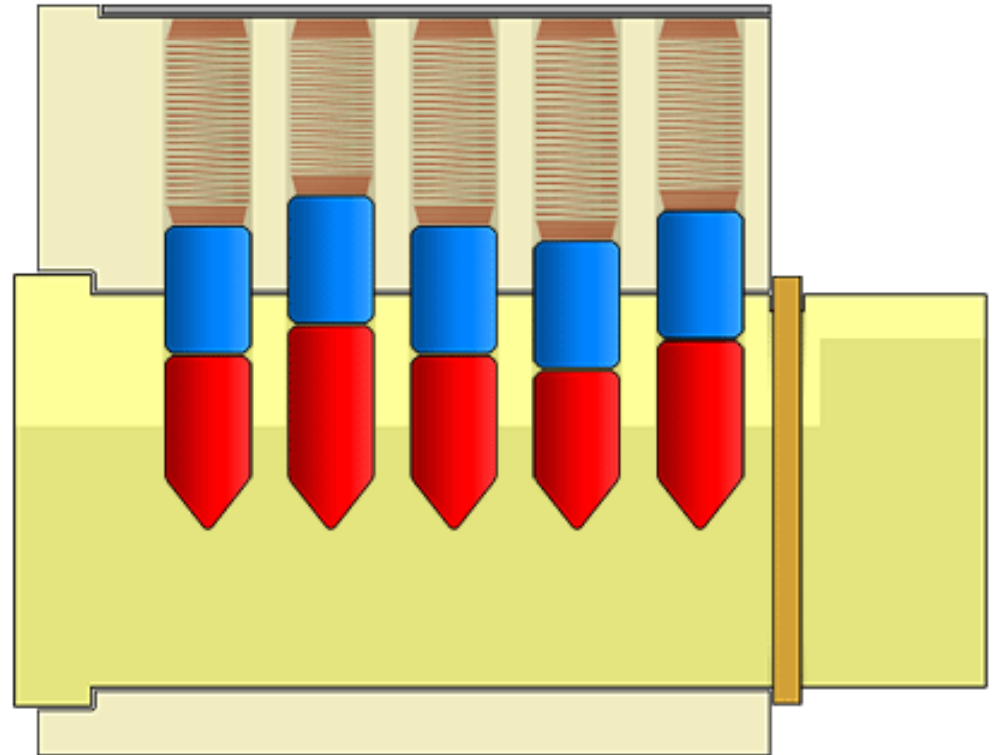

One Biting Too Low

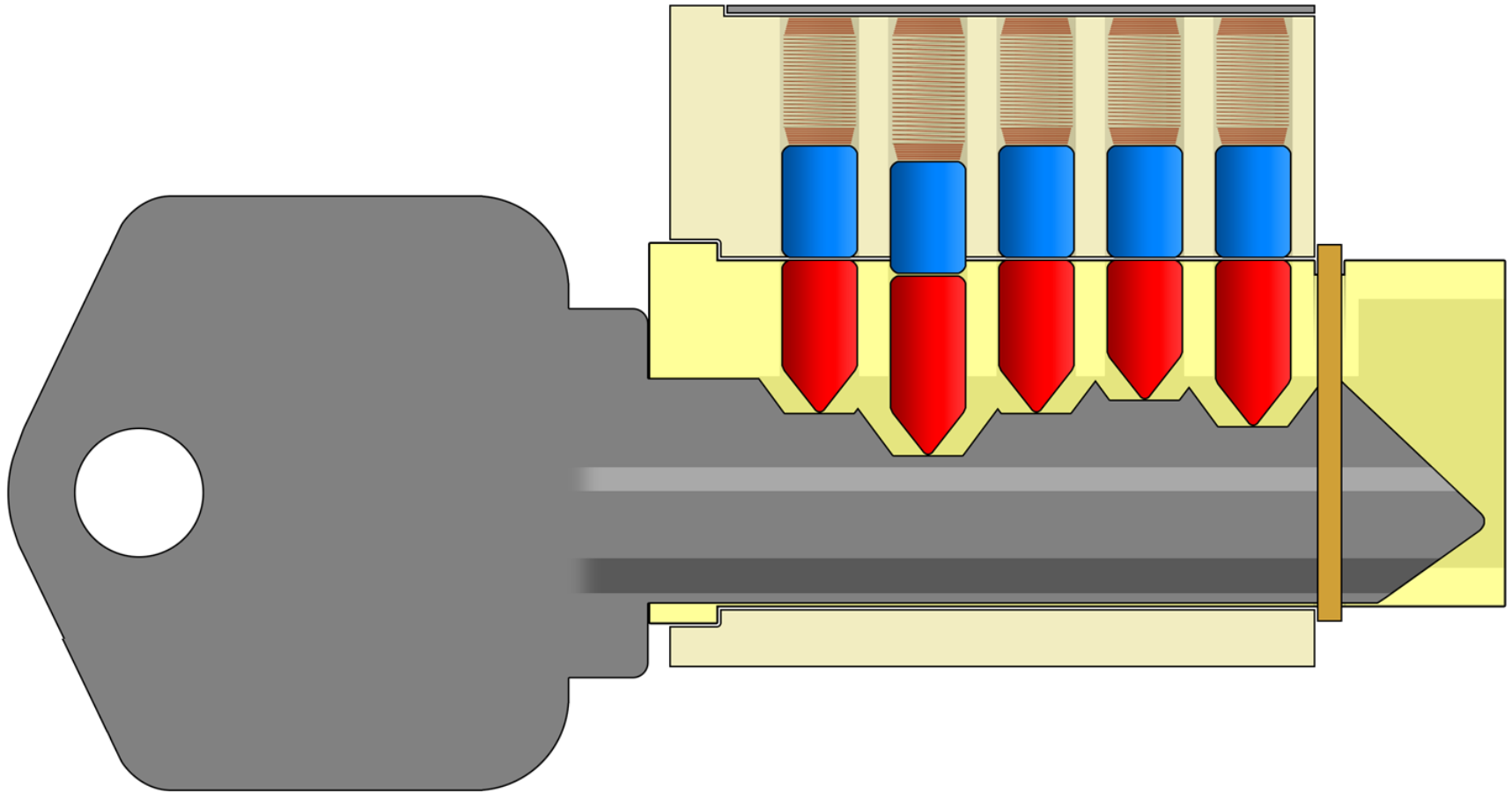

One Biting Too High

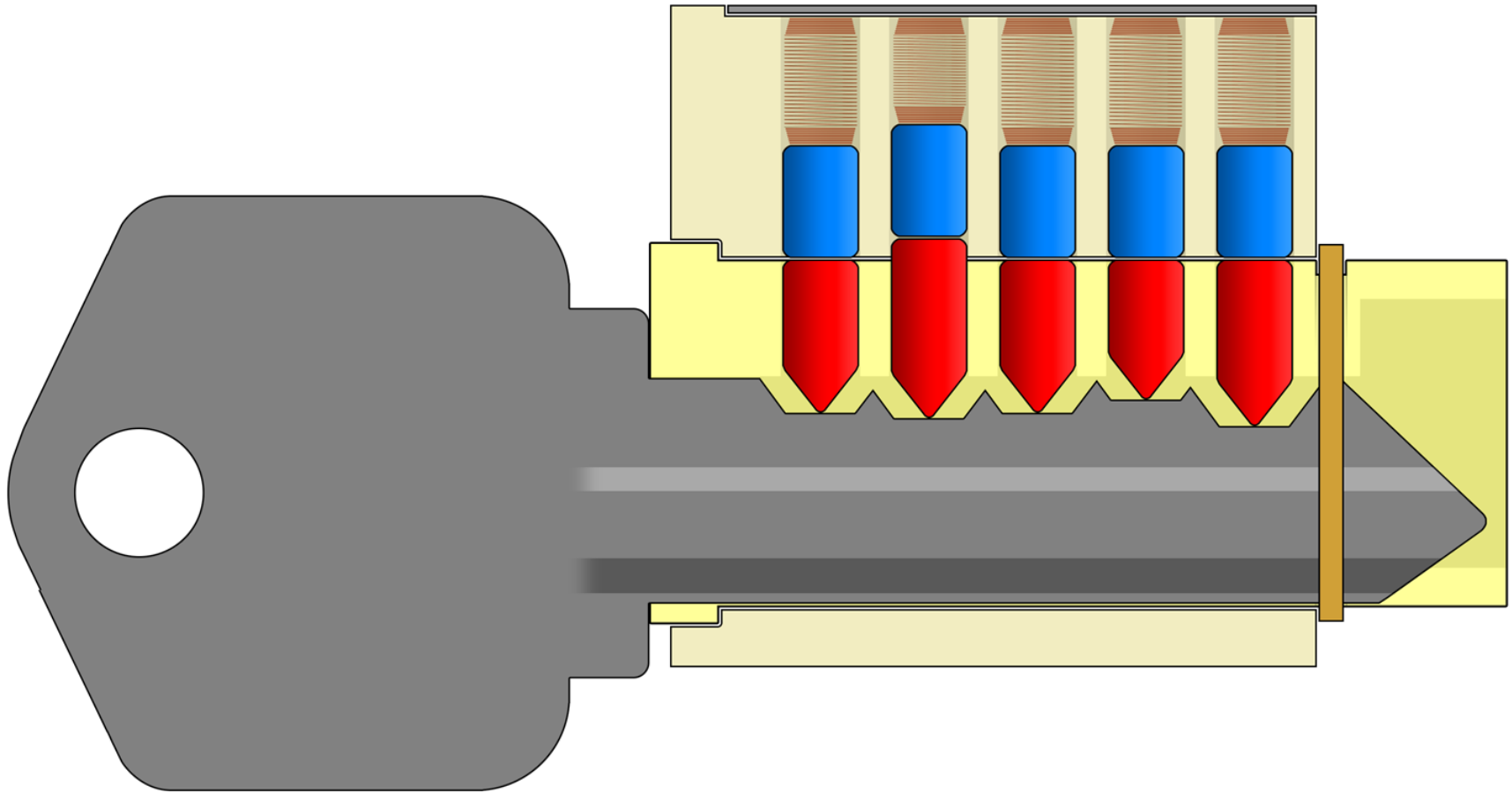

In a Perfect World

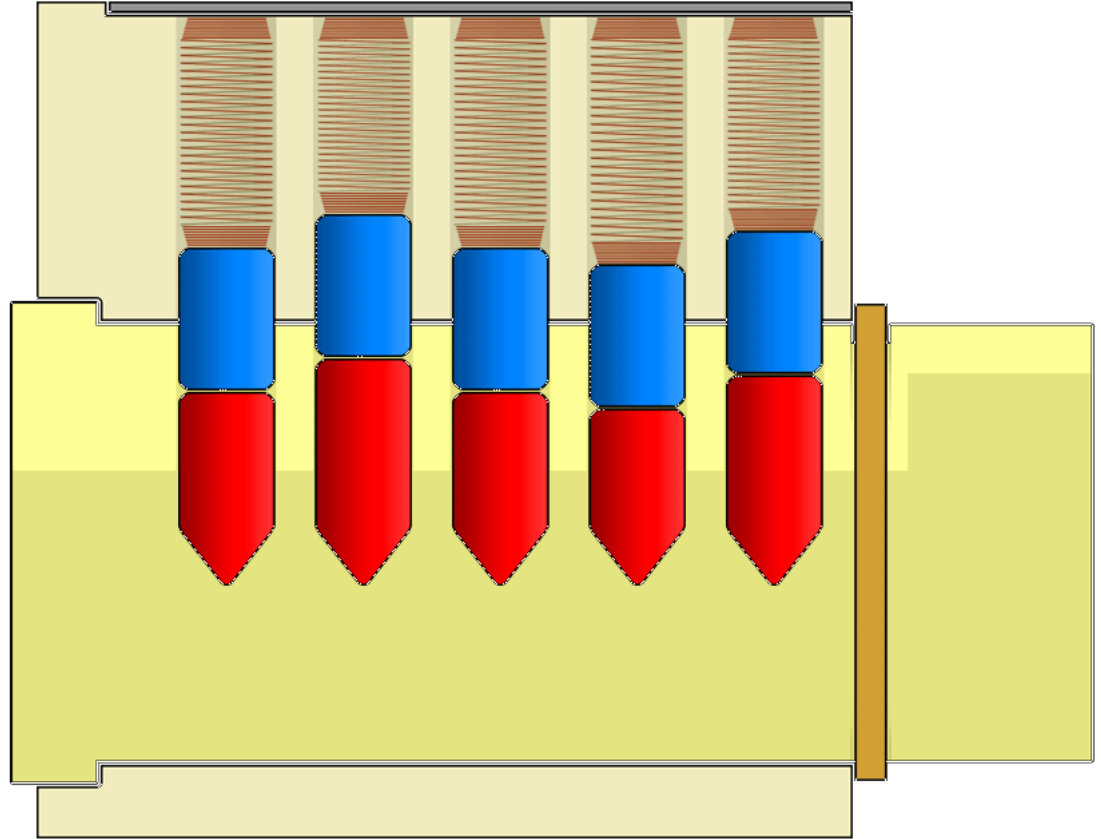
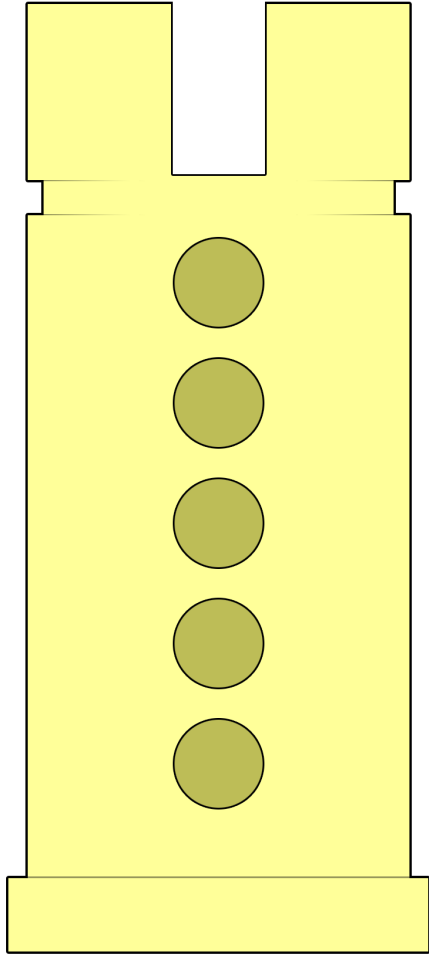

In the Real World

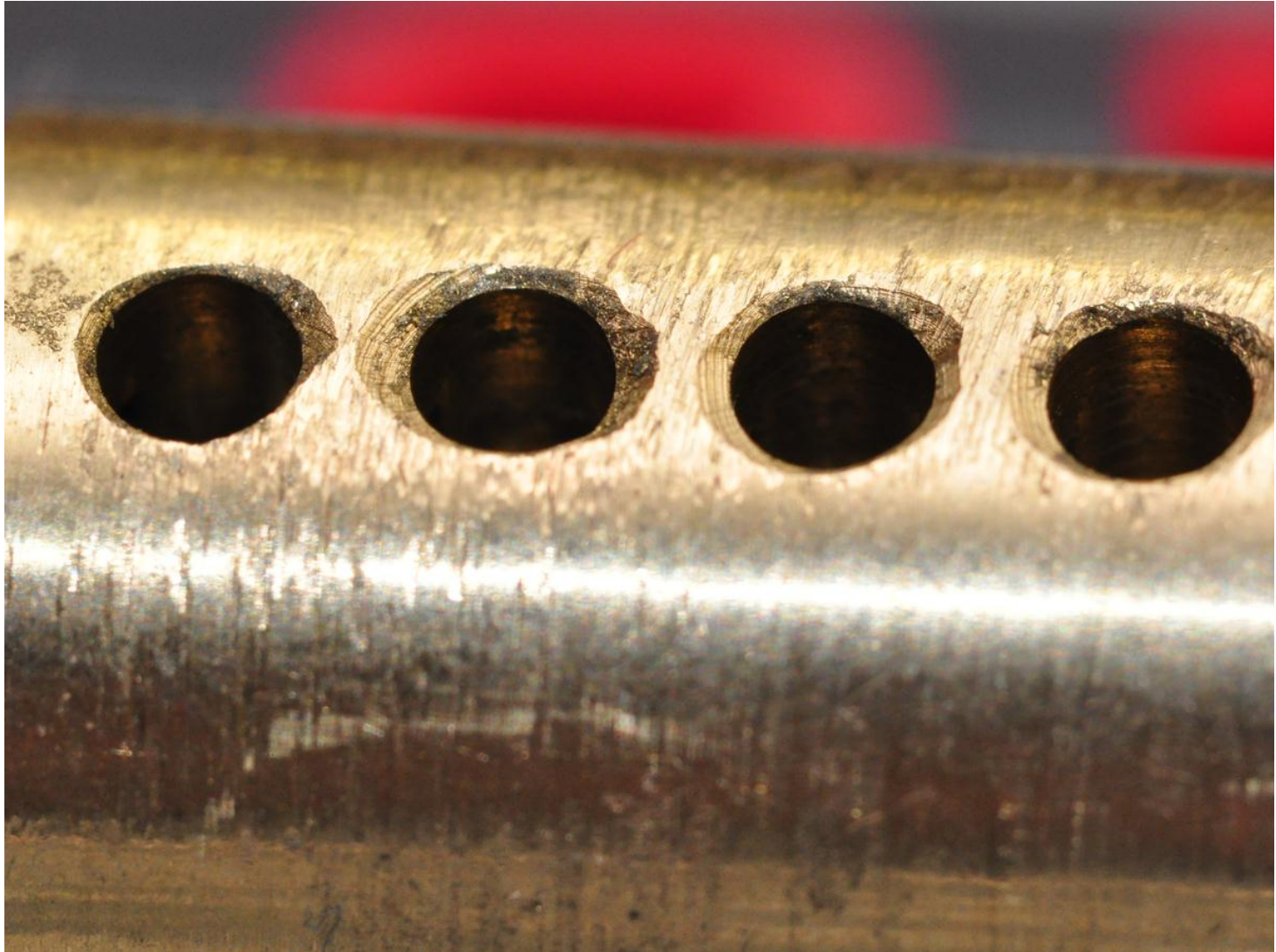

In the Real World



In the Real World

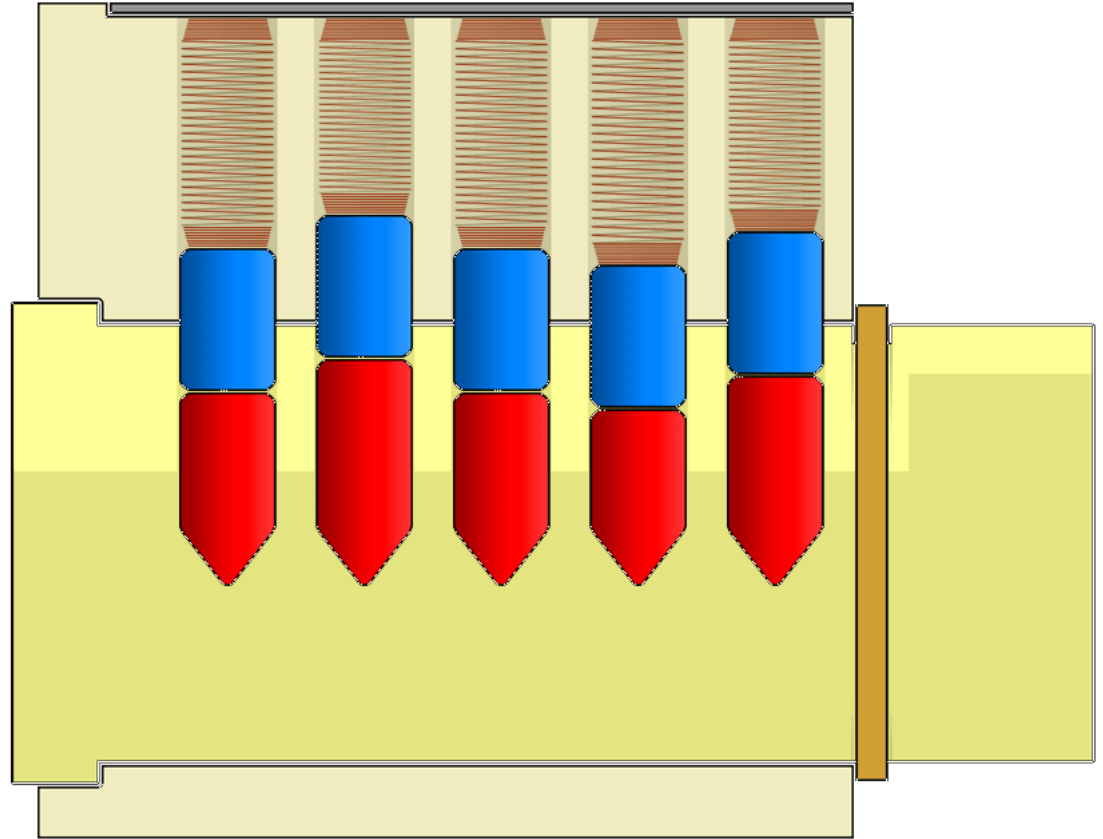
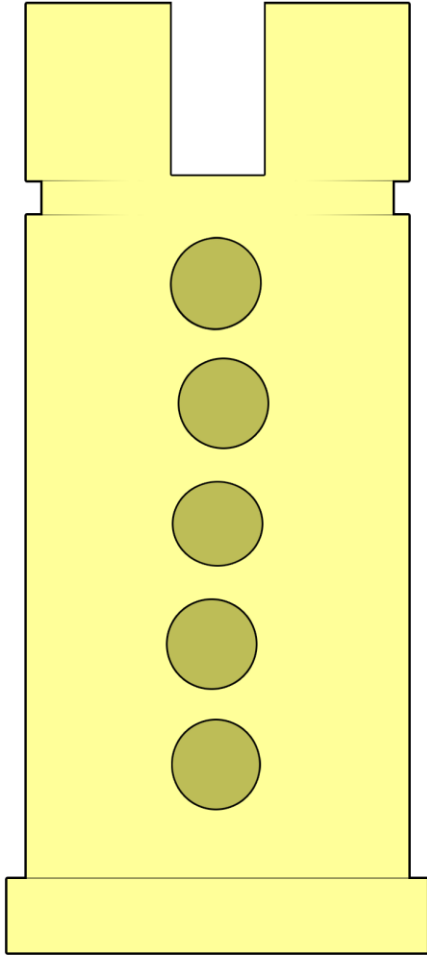

"Setting" a Binding Pin

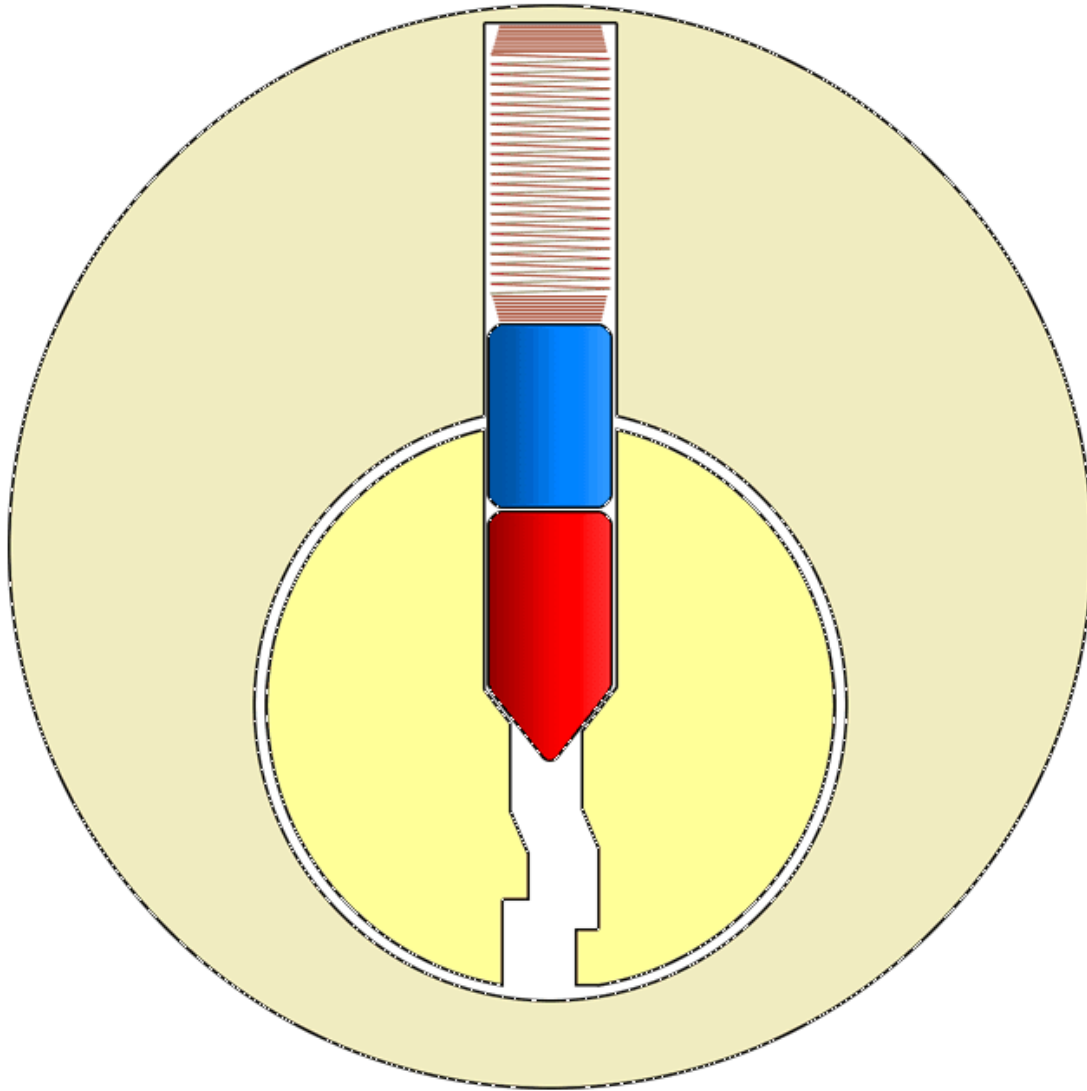

The Key Pin Can Still Move Freely

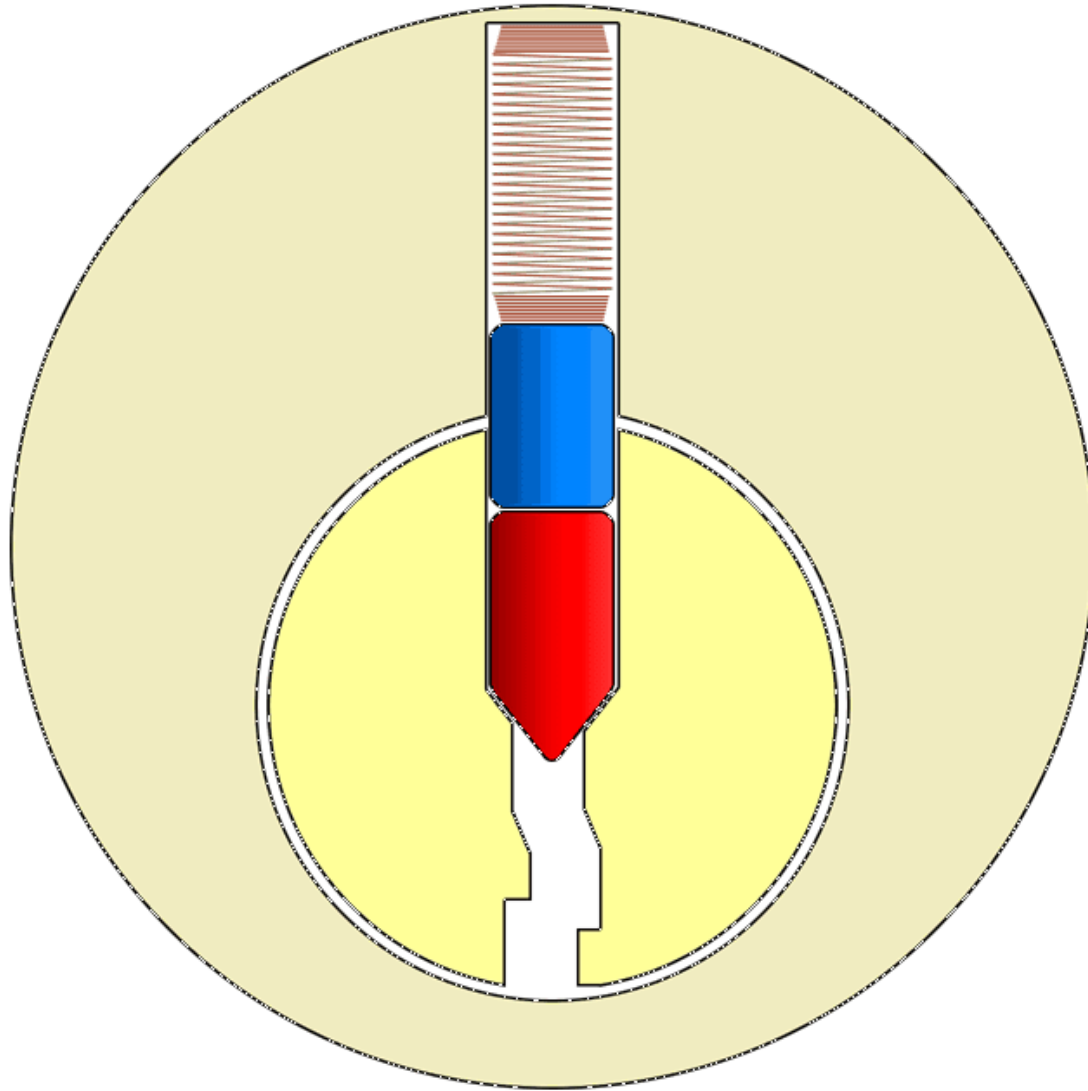

Setting Multiple Pins

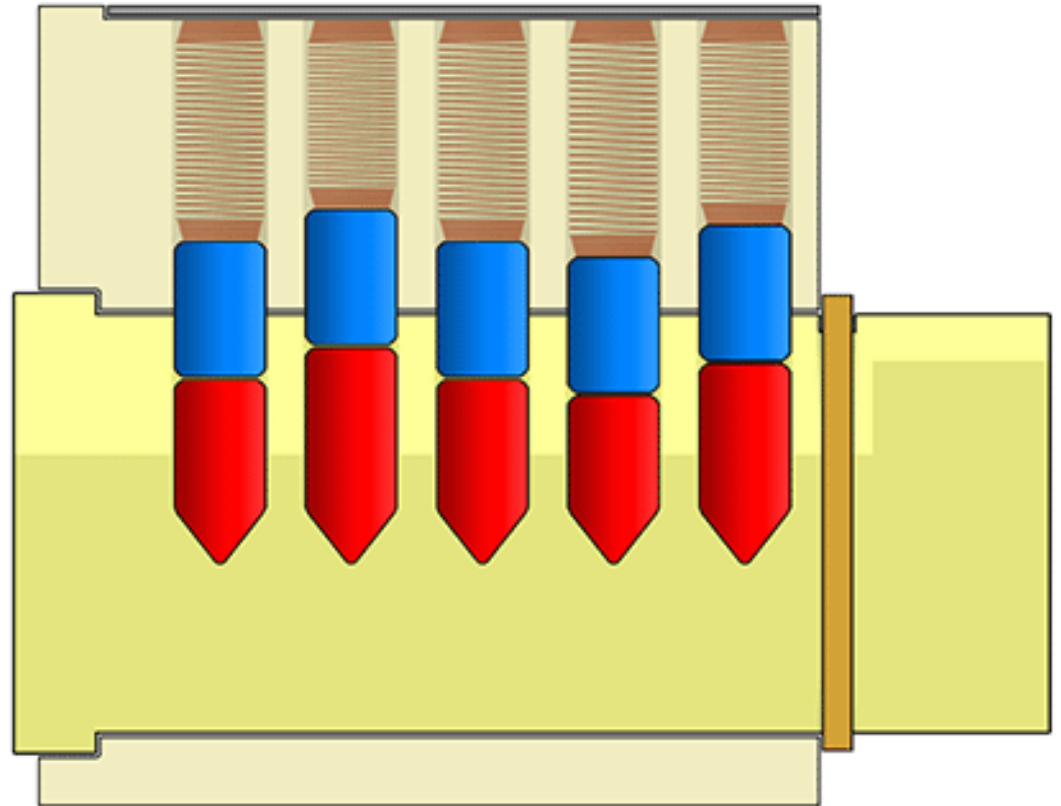

Take Caution to Avoid Over-

ifting

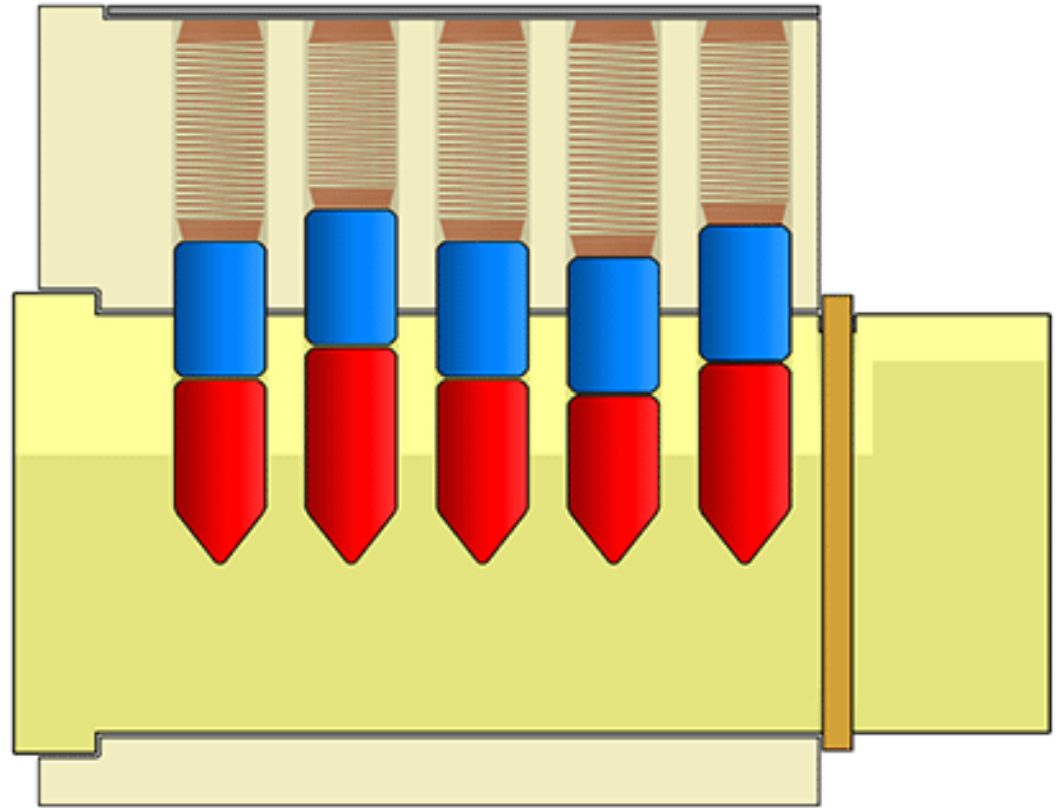

Other Tools One Uses

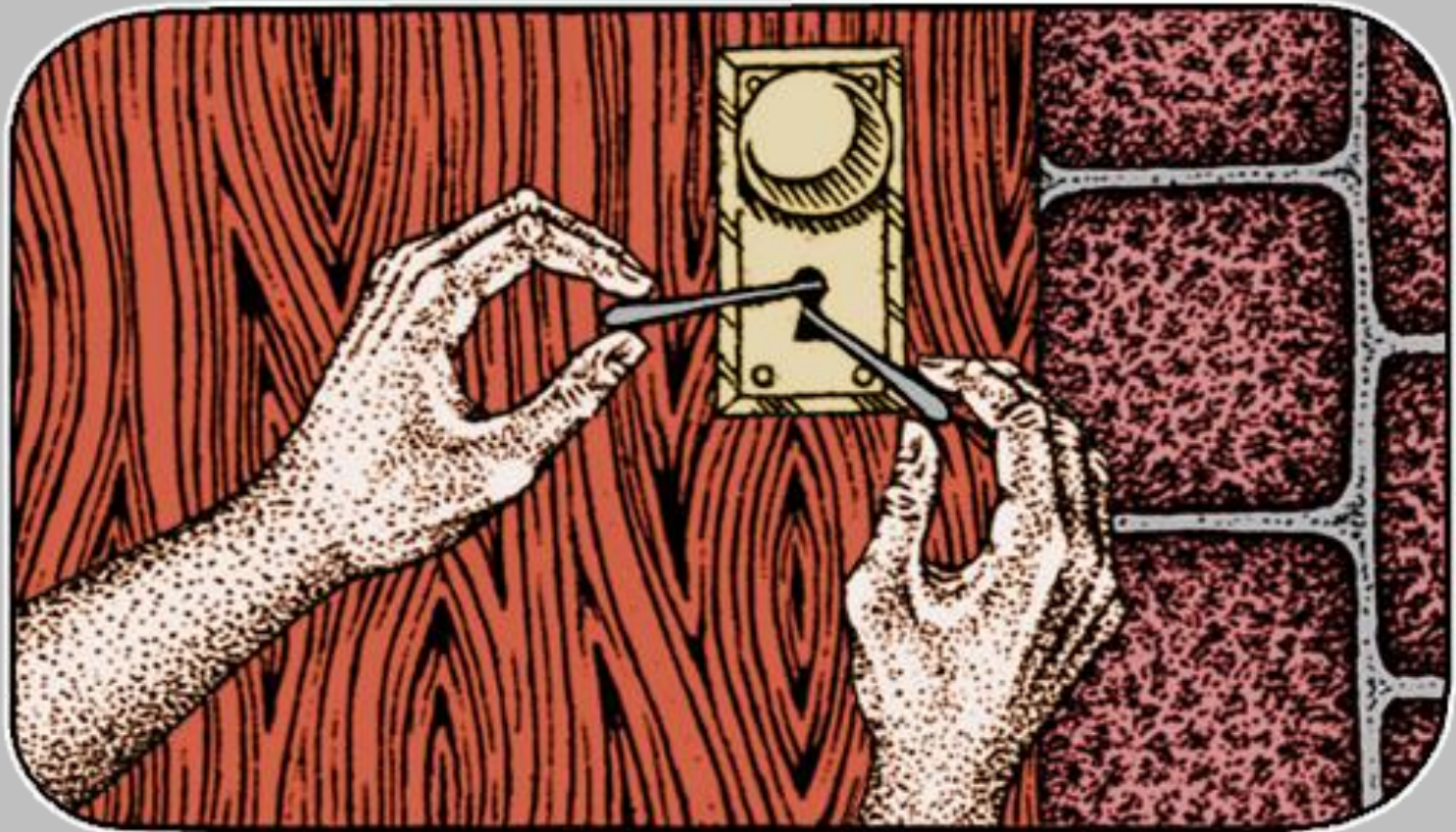

Raking

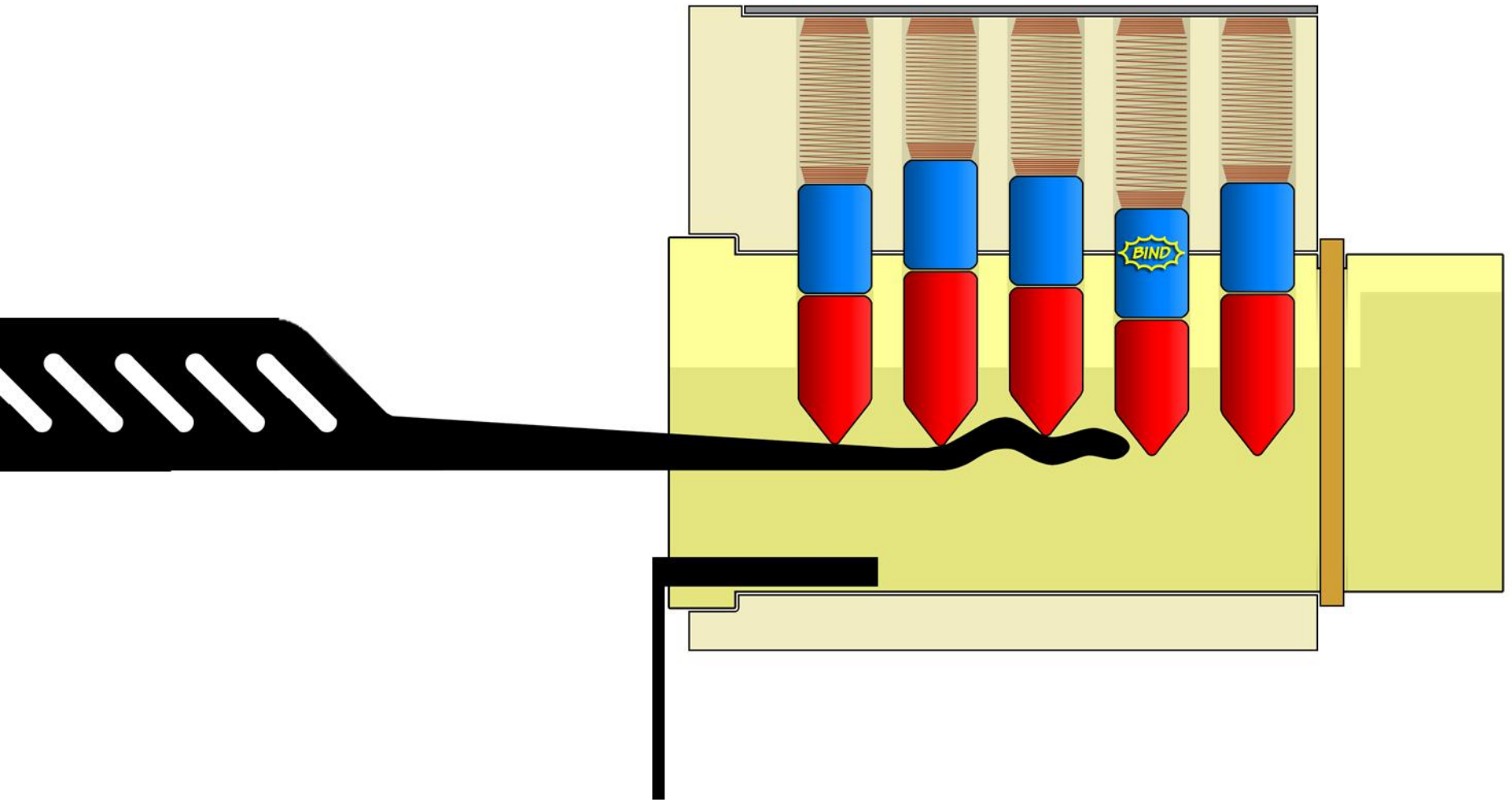

Raking

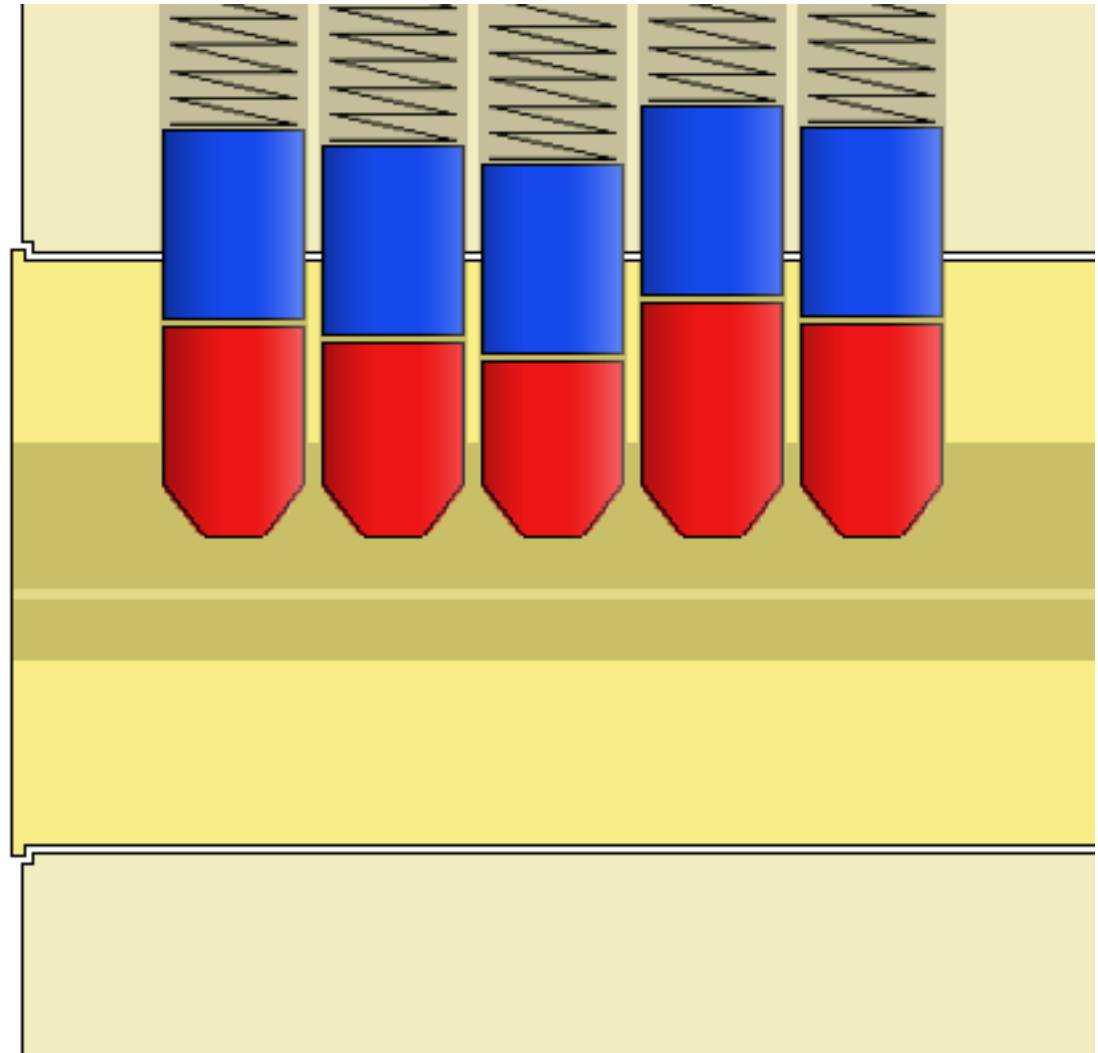

The Half-Diamond



Lifting with a Half-Diamond

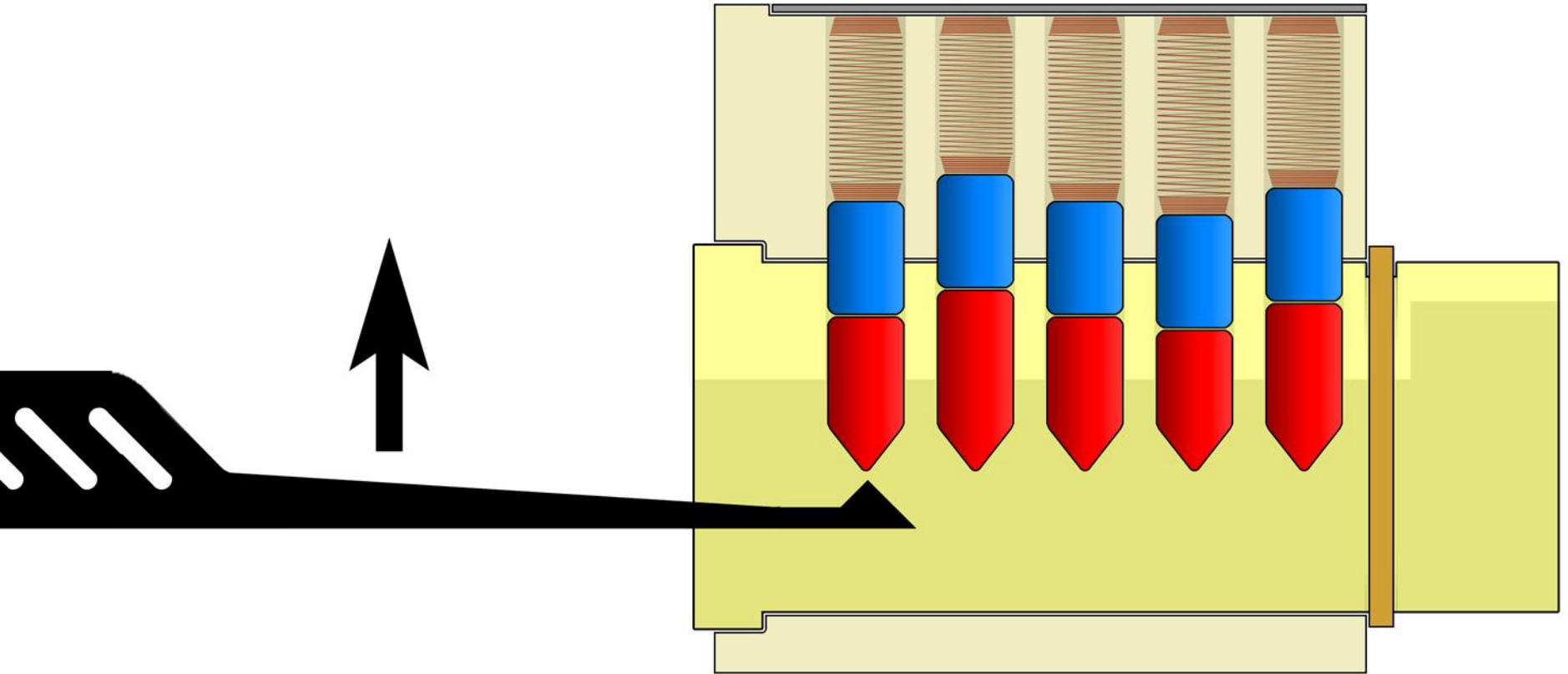

Raking / Shoveling with a Half-Diamond

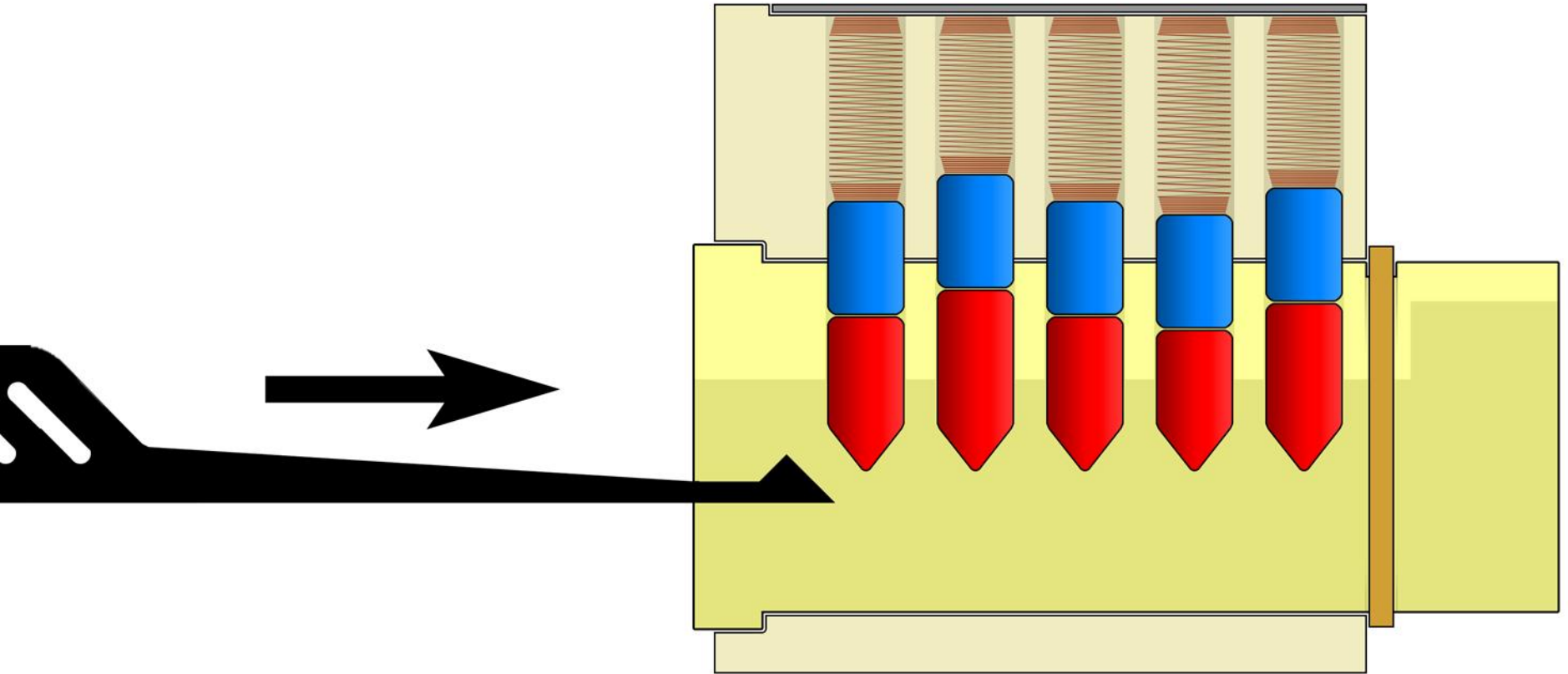

Using the Flat Underside

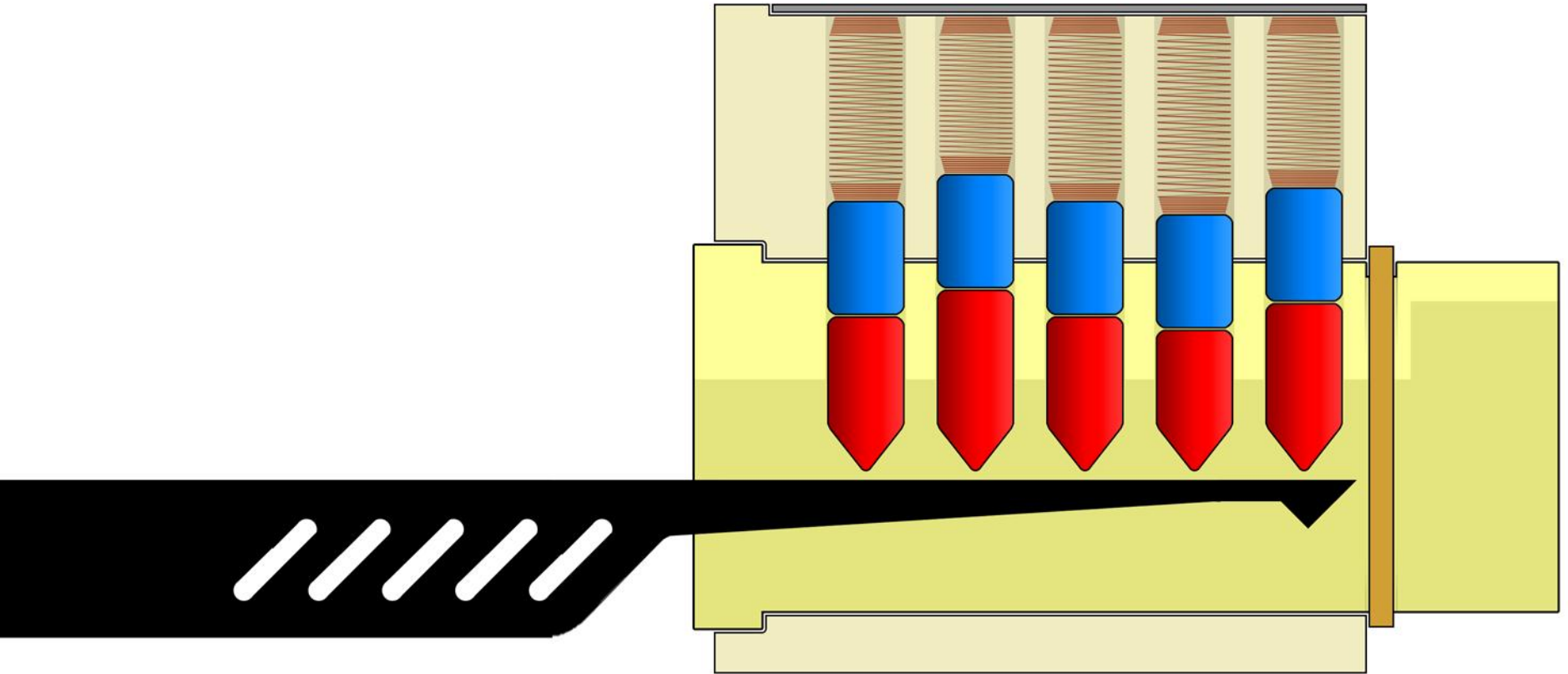

Using the Flat Underside

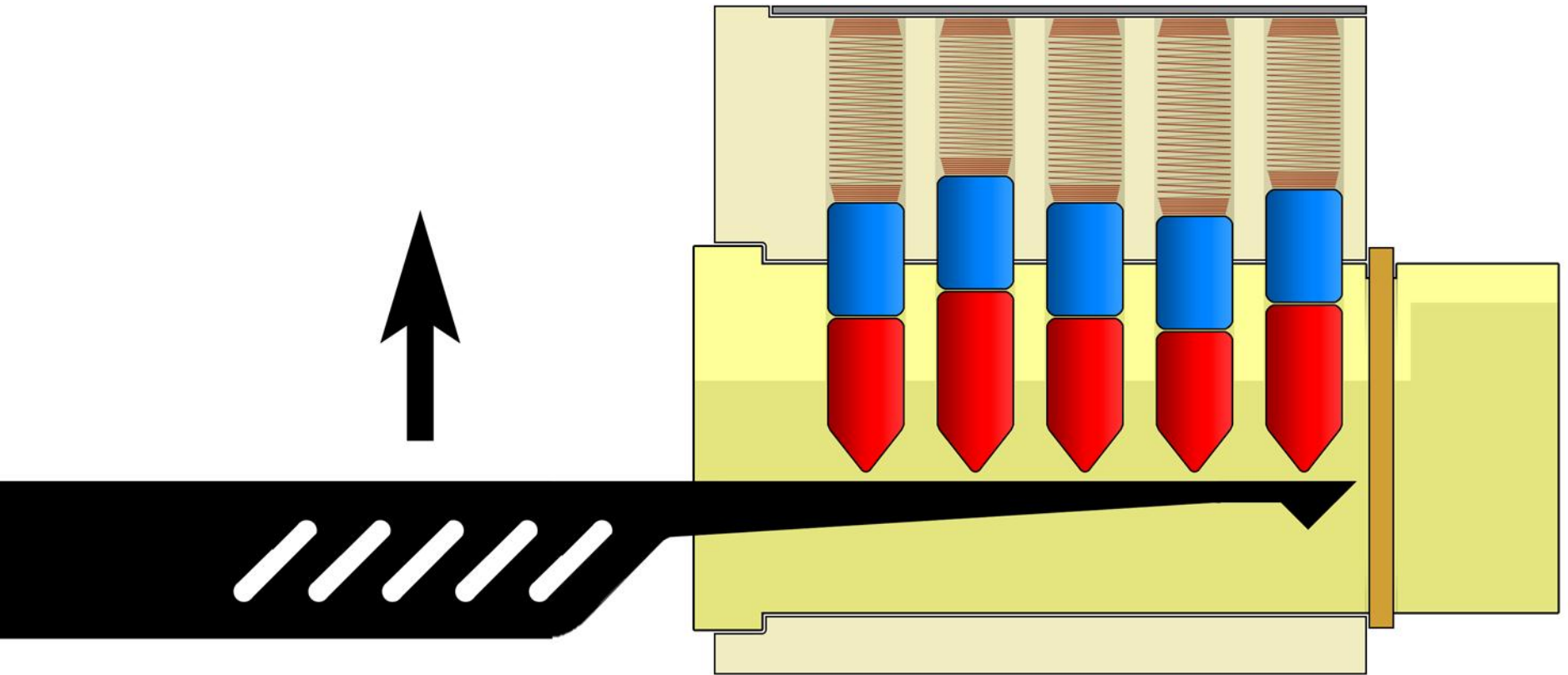

Counting Pin Stacks

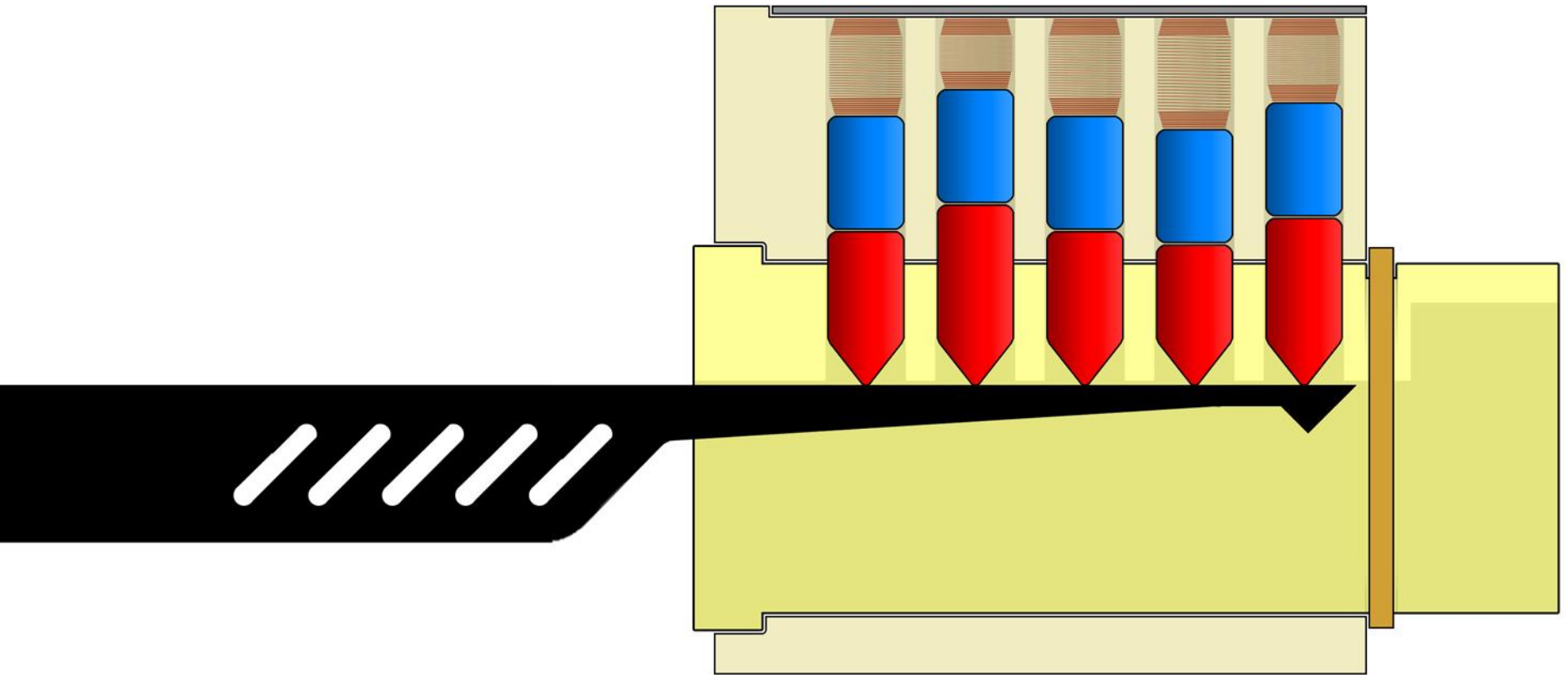

Counting Pin Stacks

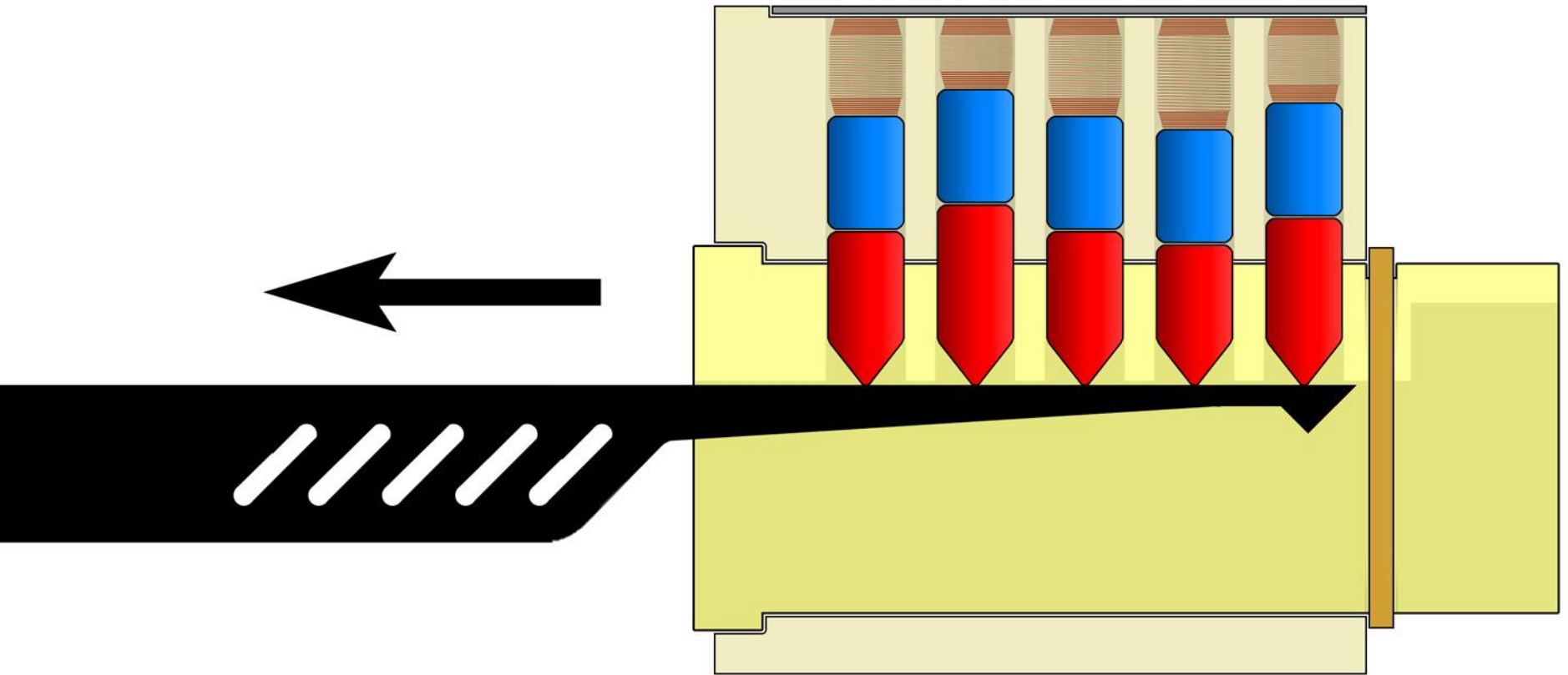

Turning Tools

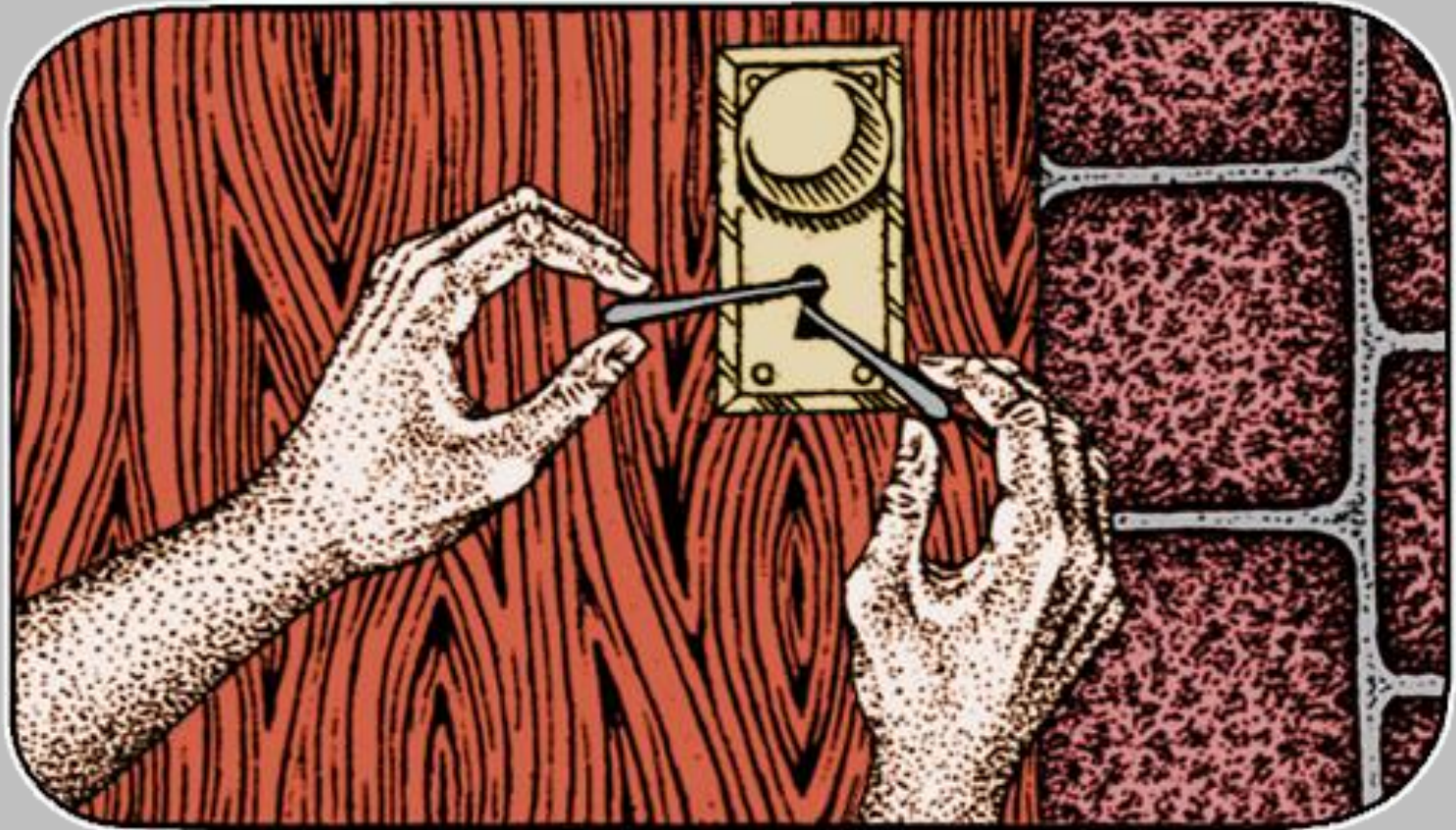

Bad Turning Tool Usage (Pulling)



Better Turning Tool Usage (Pushing)

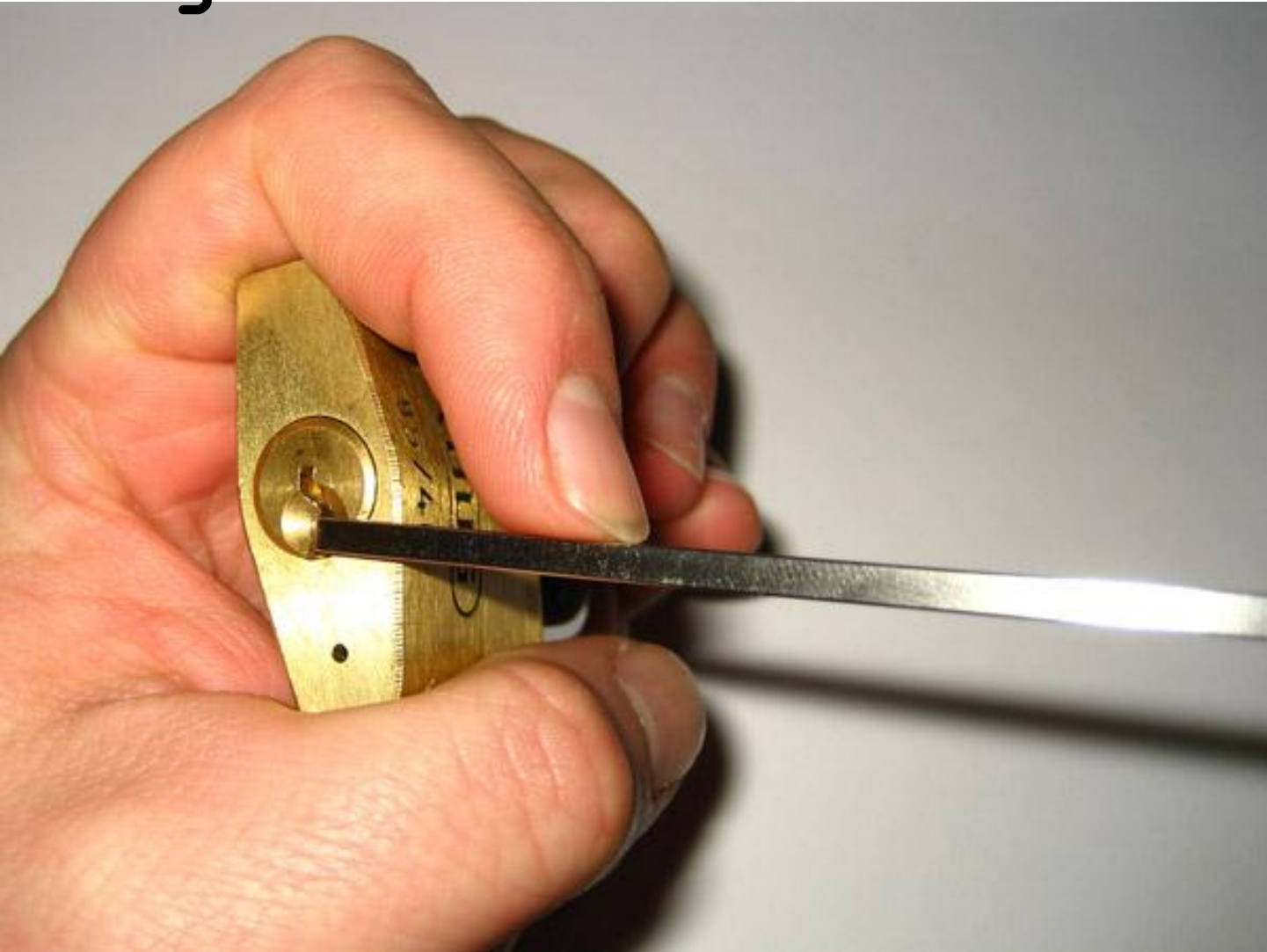

Best Turning Tool Usage (Pushing Out at Tip)

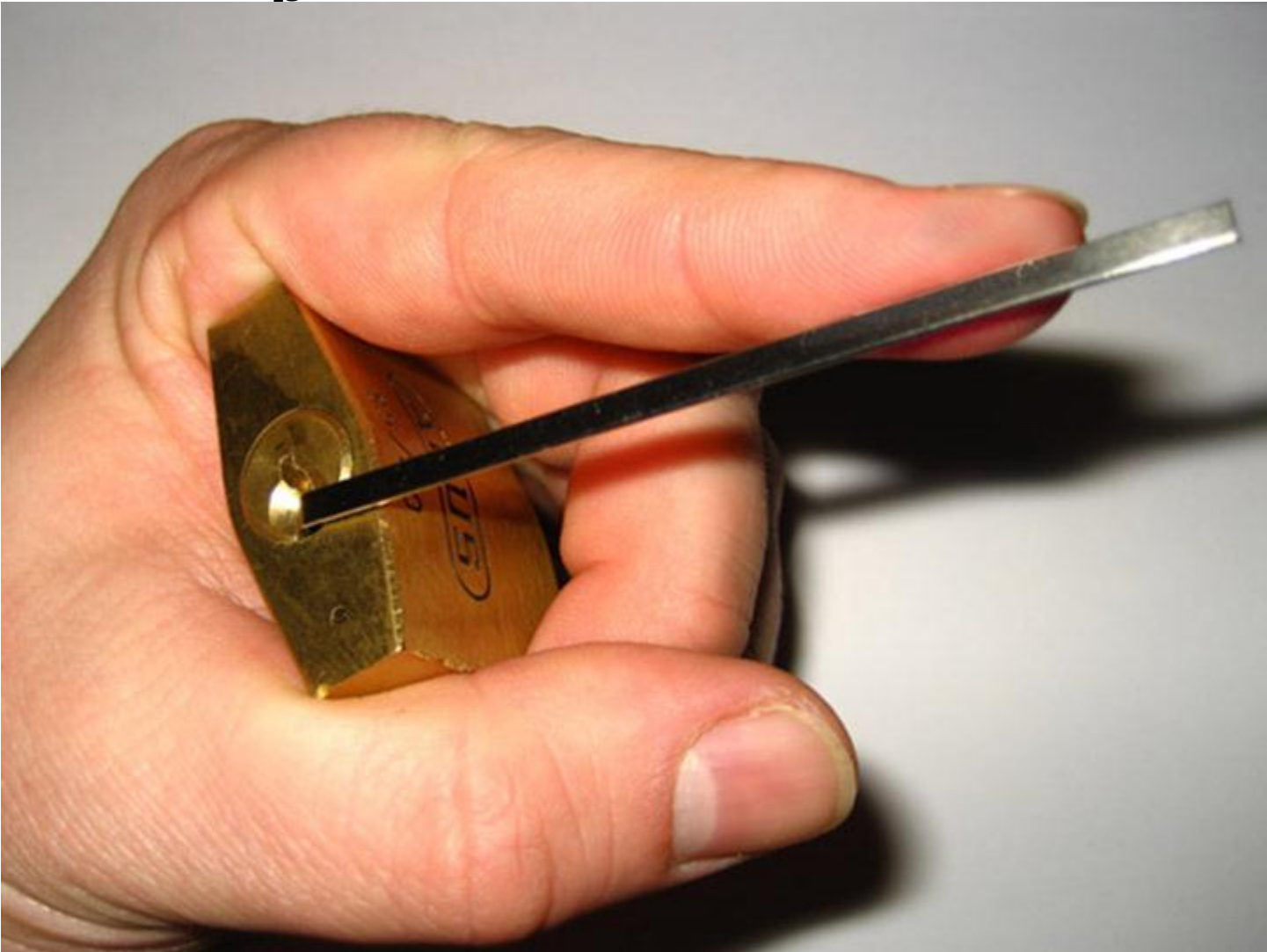

Good Turning Tool Pressure

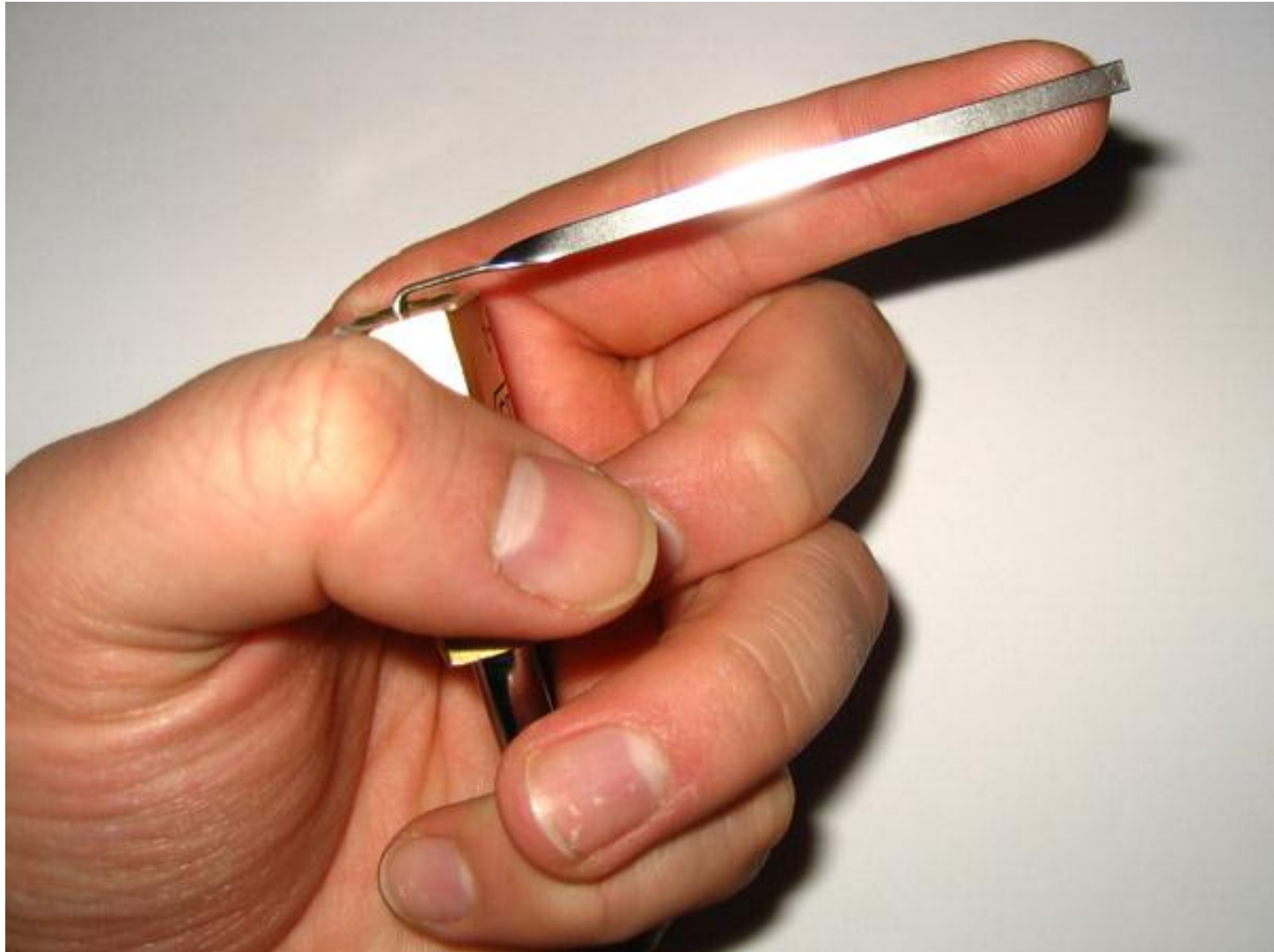

Too Much Turning Tool Pressure!

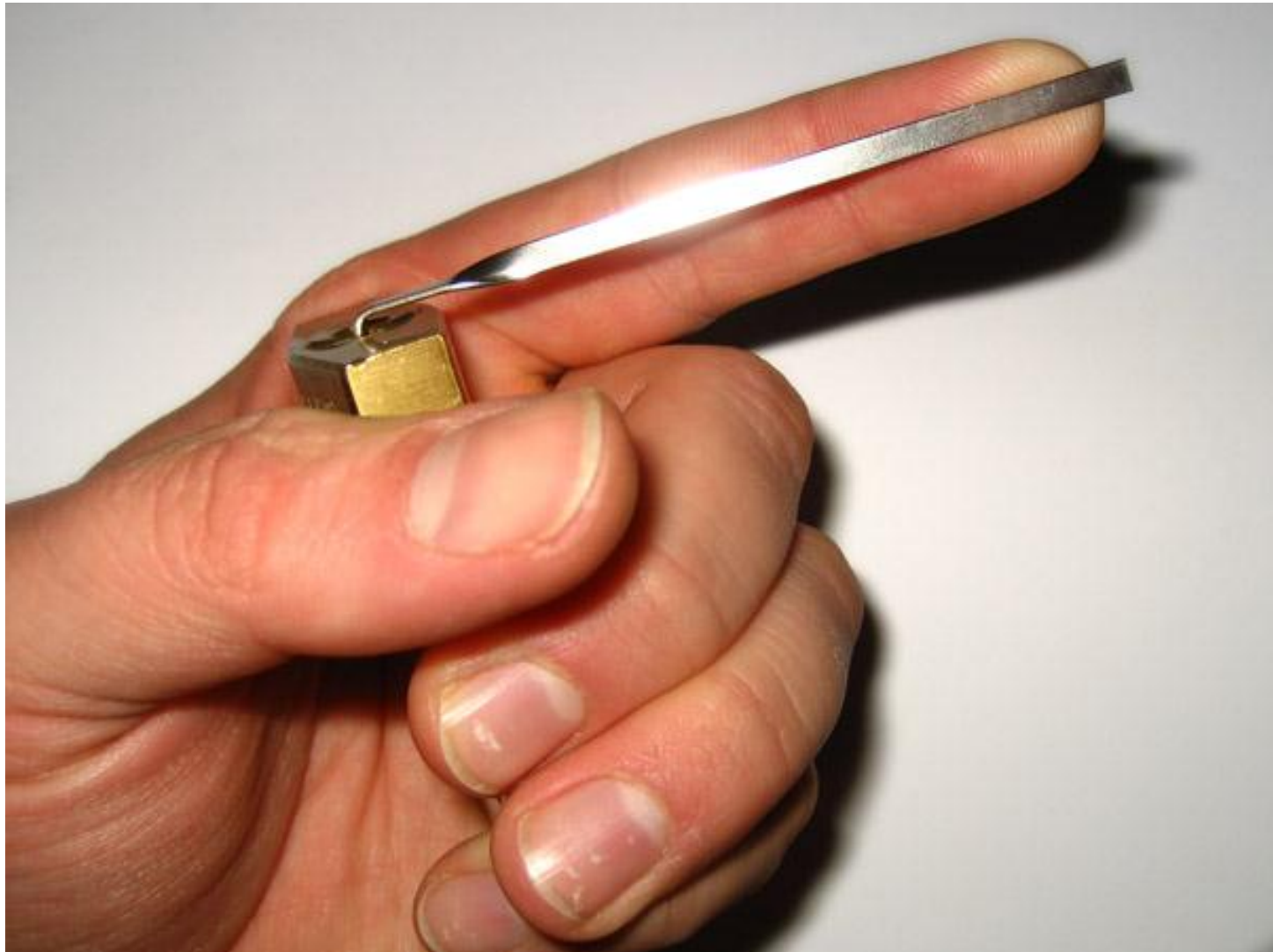

Turning Tool Position: "Edge of the Plug"



"Standard" Turning Tools



Space in the Keyway

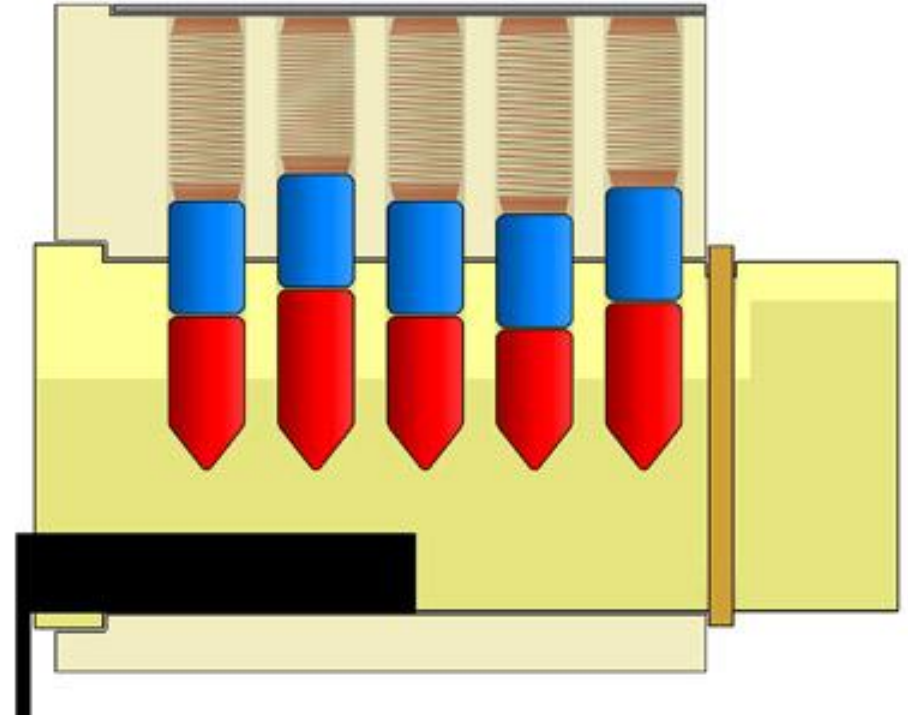
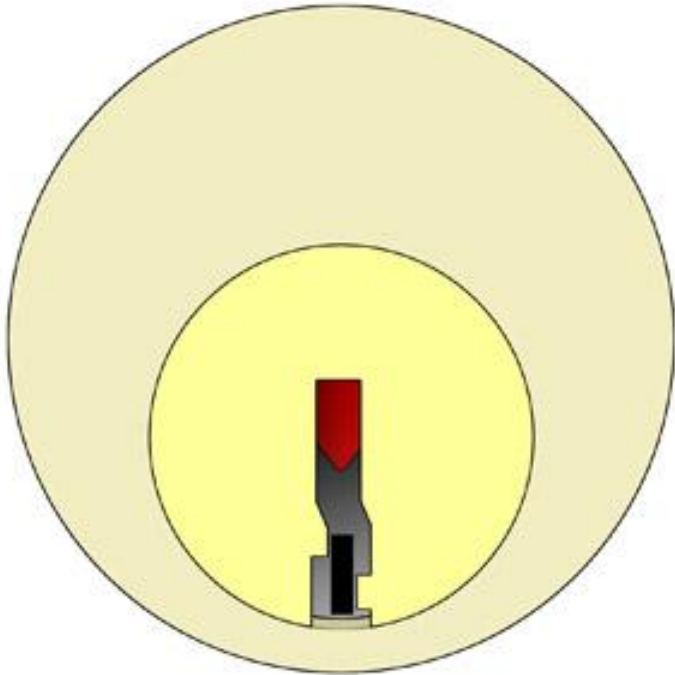

Space in the Keyway

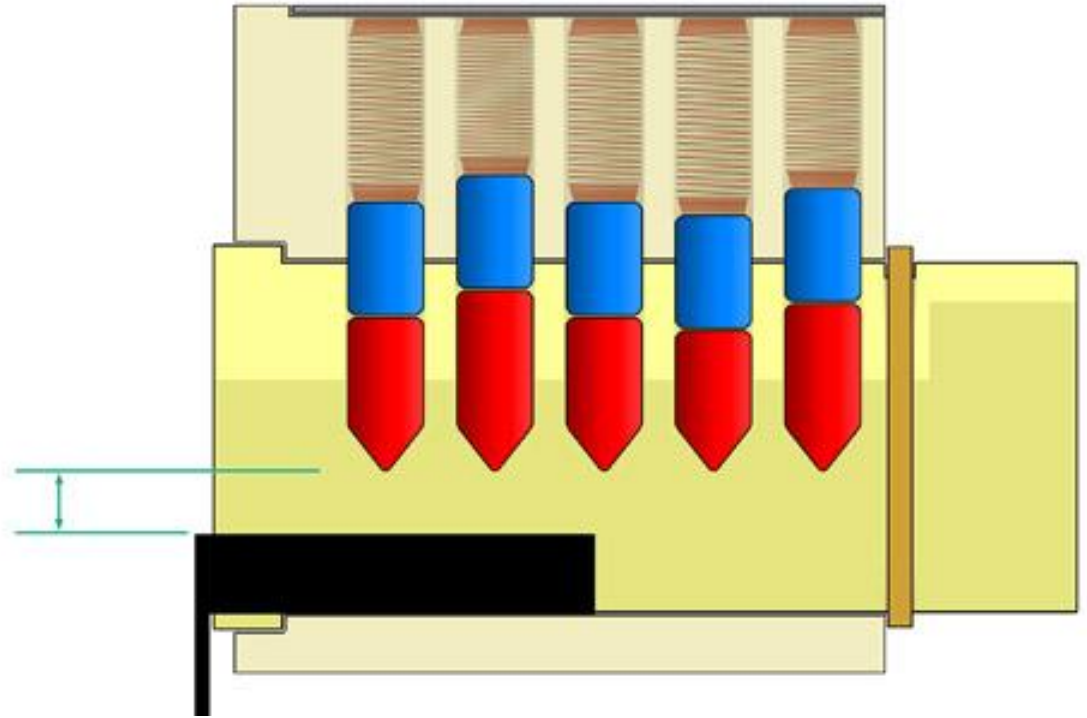
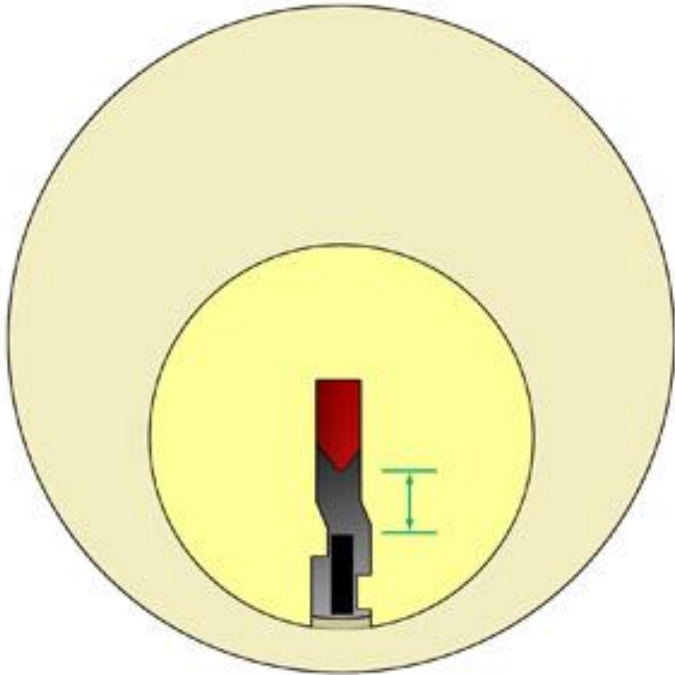

Careful to not Cause Extra Friction

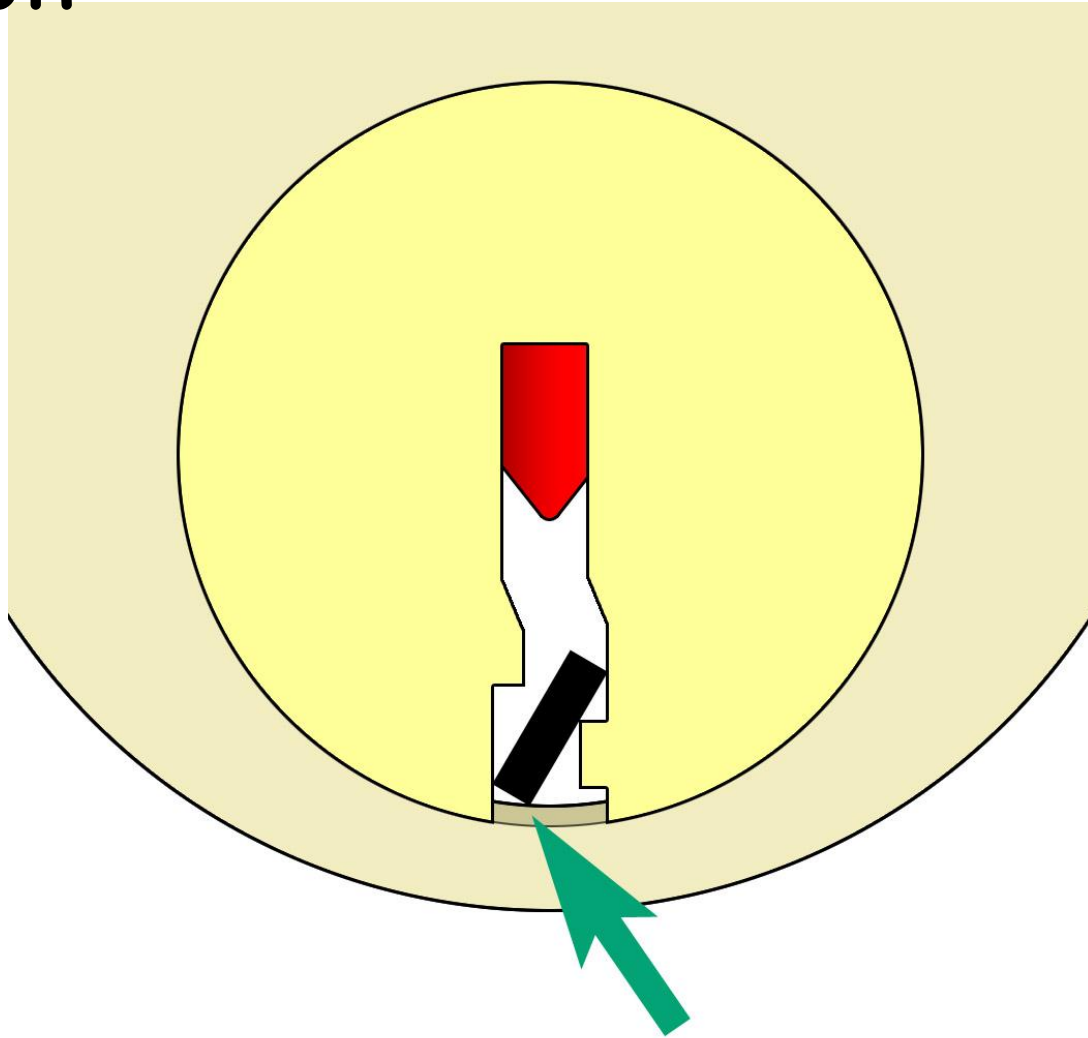

"Standard" vs "Flat" Turning Tools



Turning Tool Position: "Center of the Plug"



More Space in the Keyway

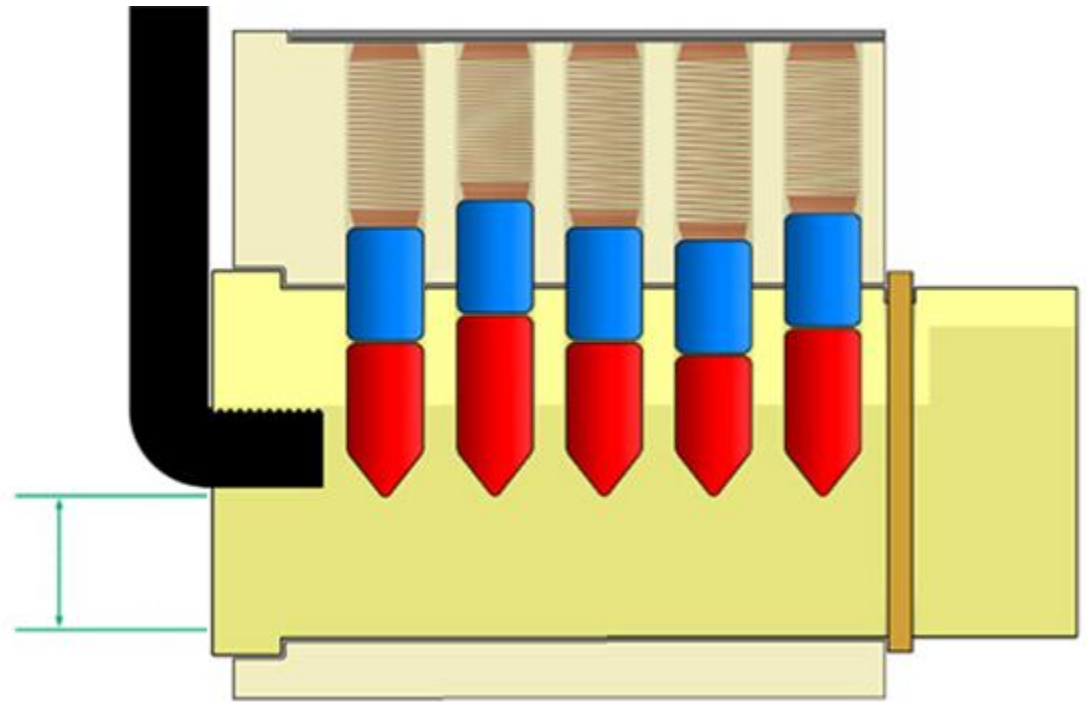
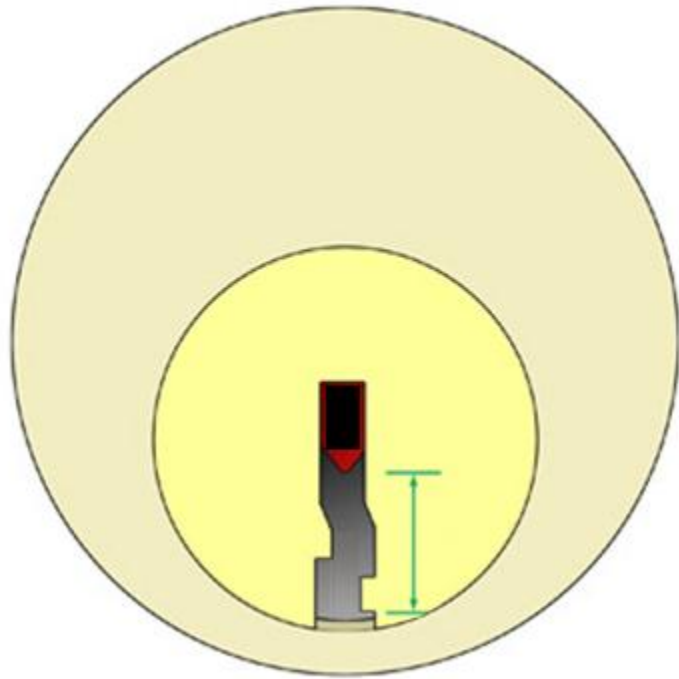

Turning Direction

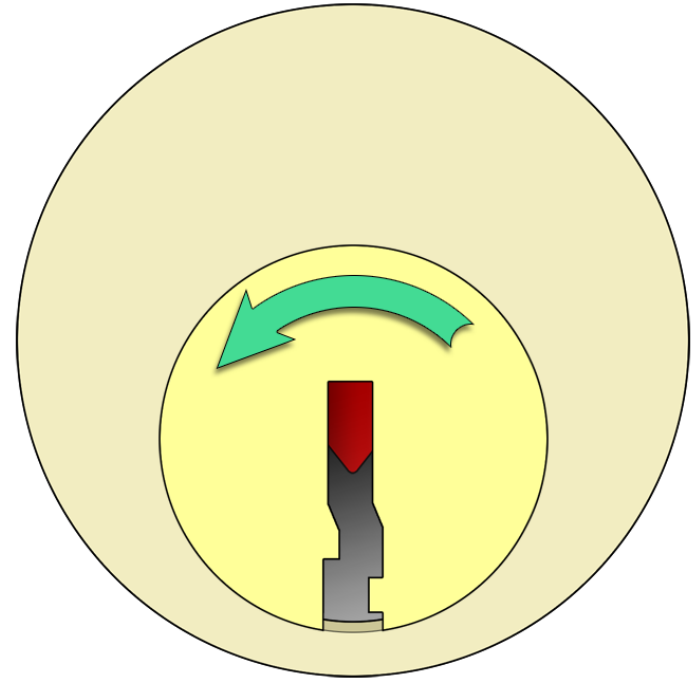
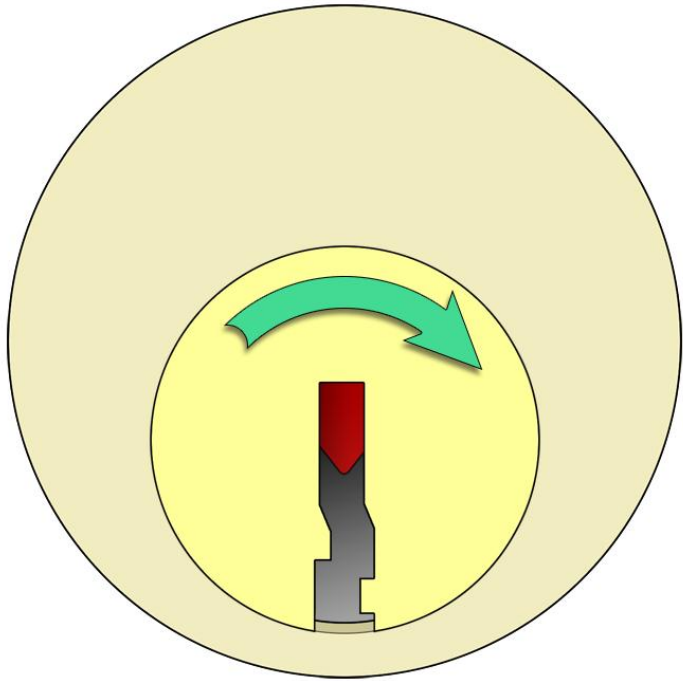

Turning Direction

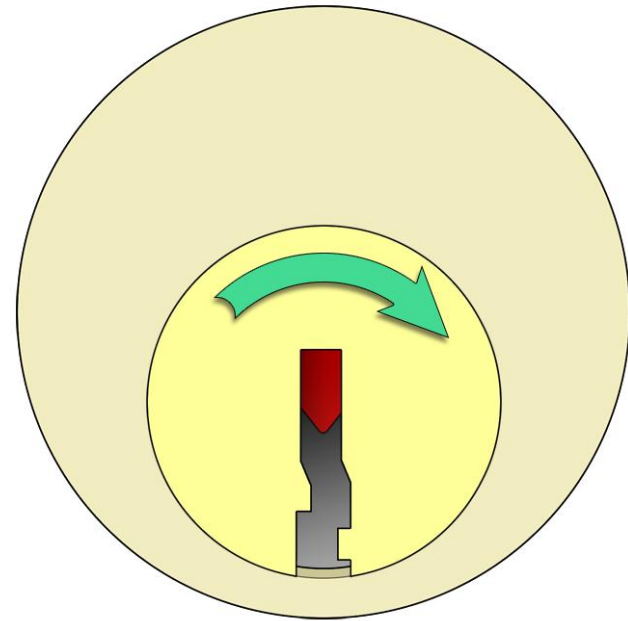

Turning Direction

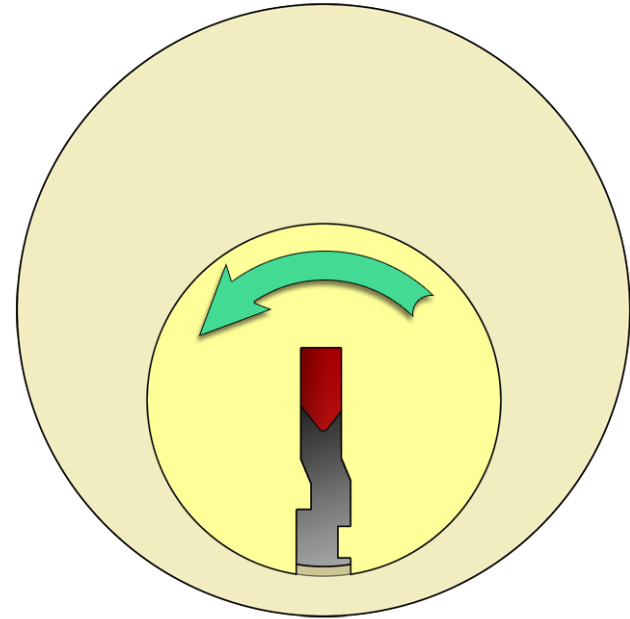

Turning Direction

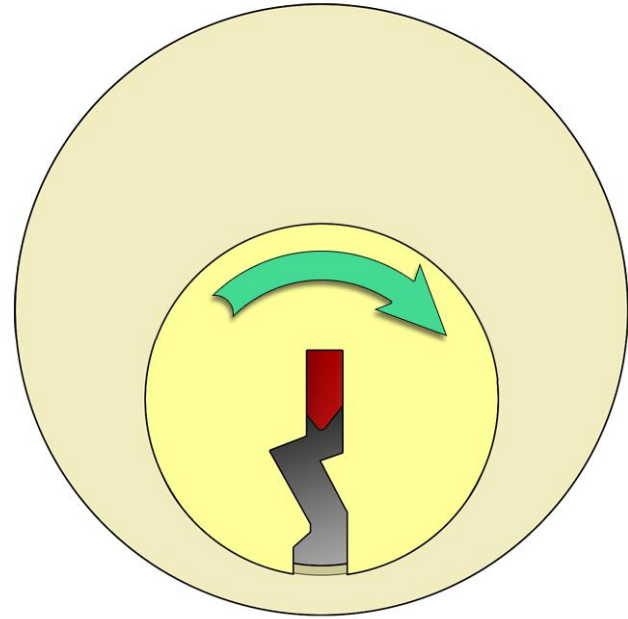

Turning Direction



Turning Direction

Left-Handed Door
Right-Handed Door

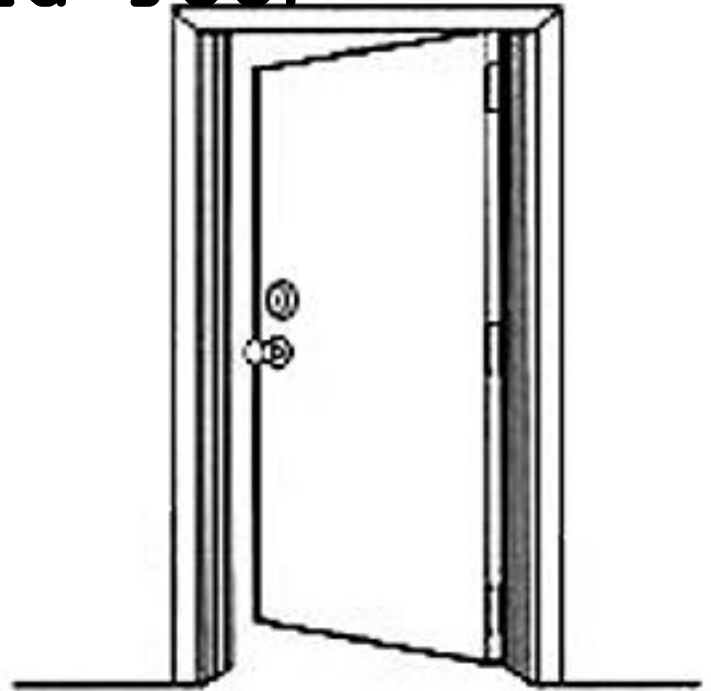
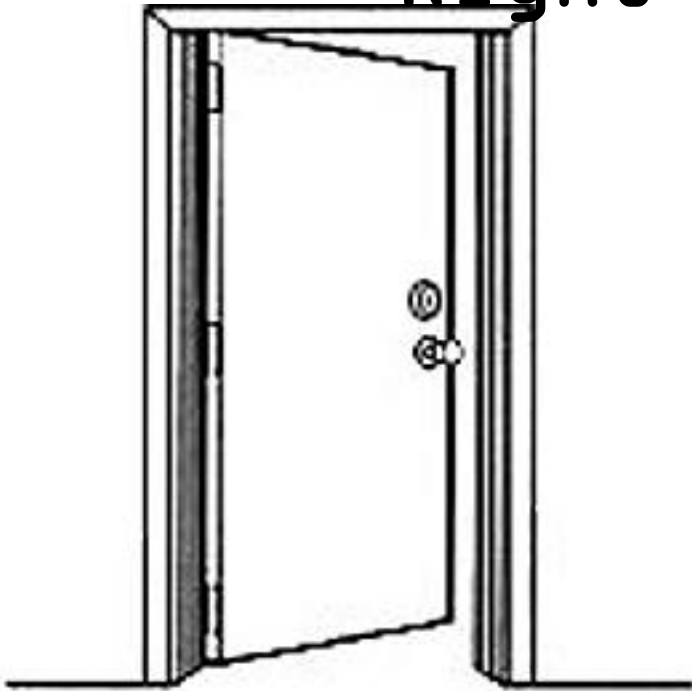

Who Wants To Try?

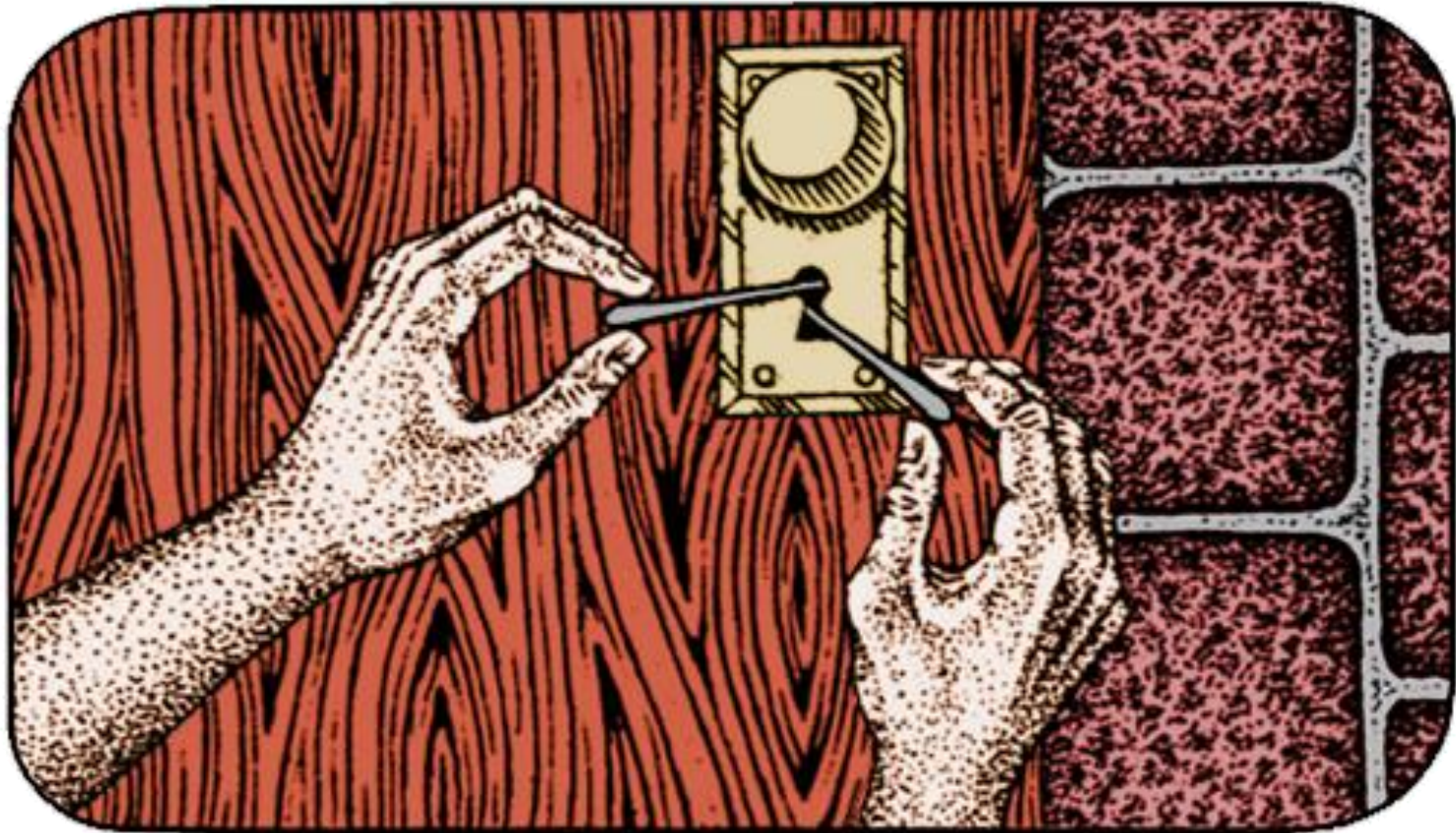

Practice Locks



Either Direction Will Work

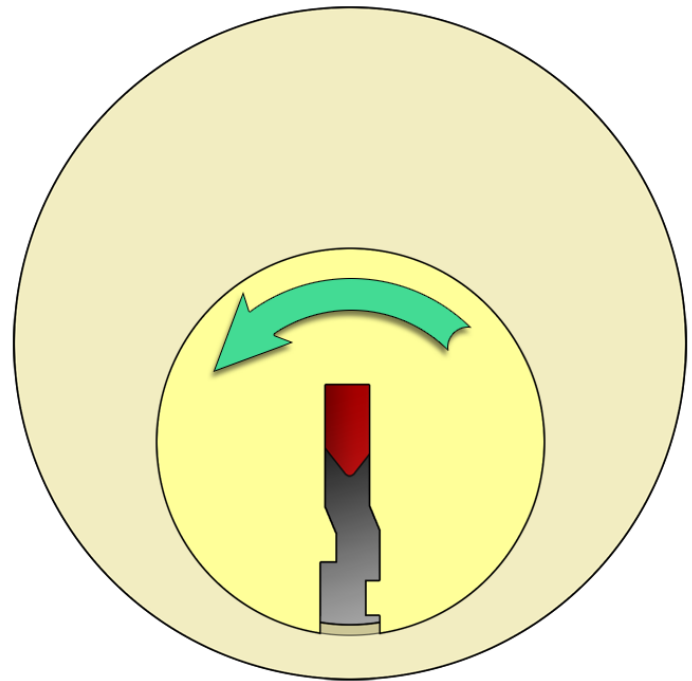
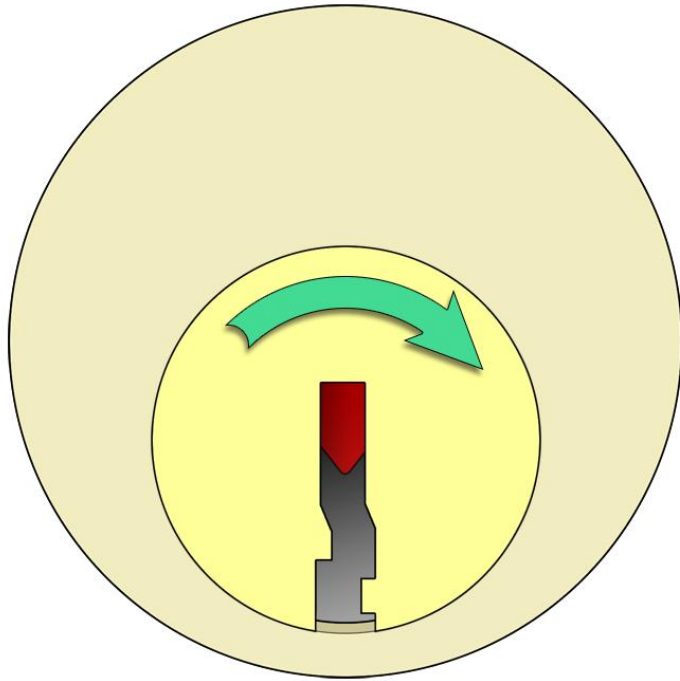

Starter Exercises

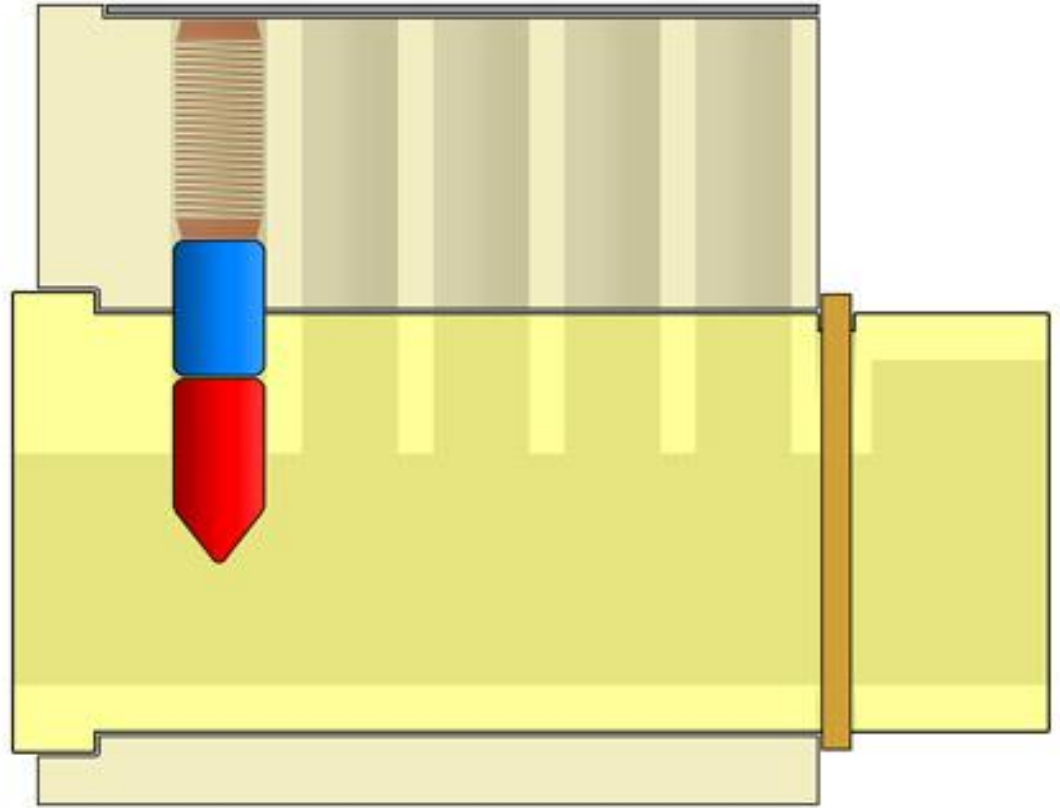

Starter Exercises

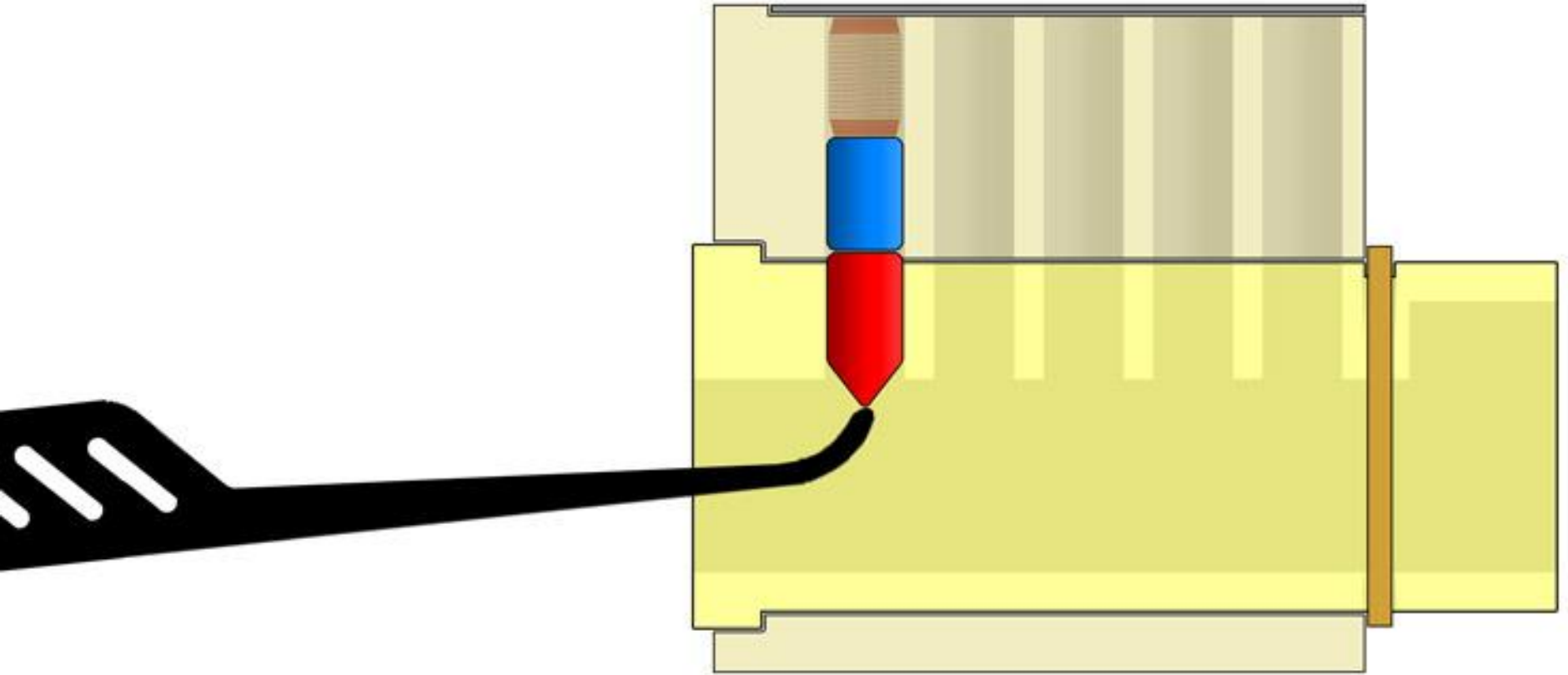

Starter Exercises

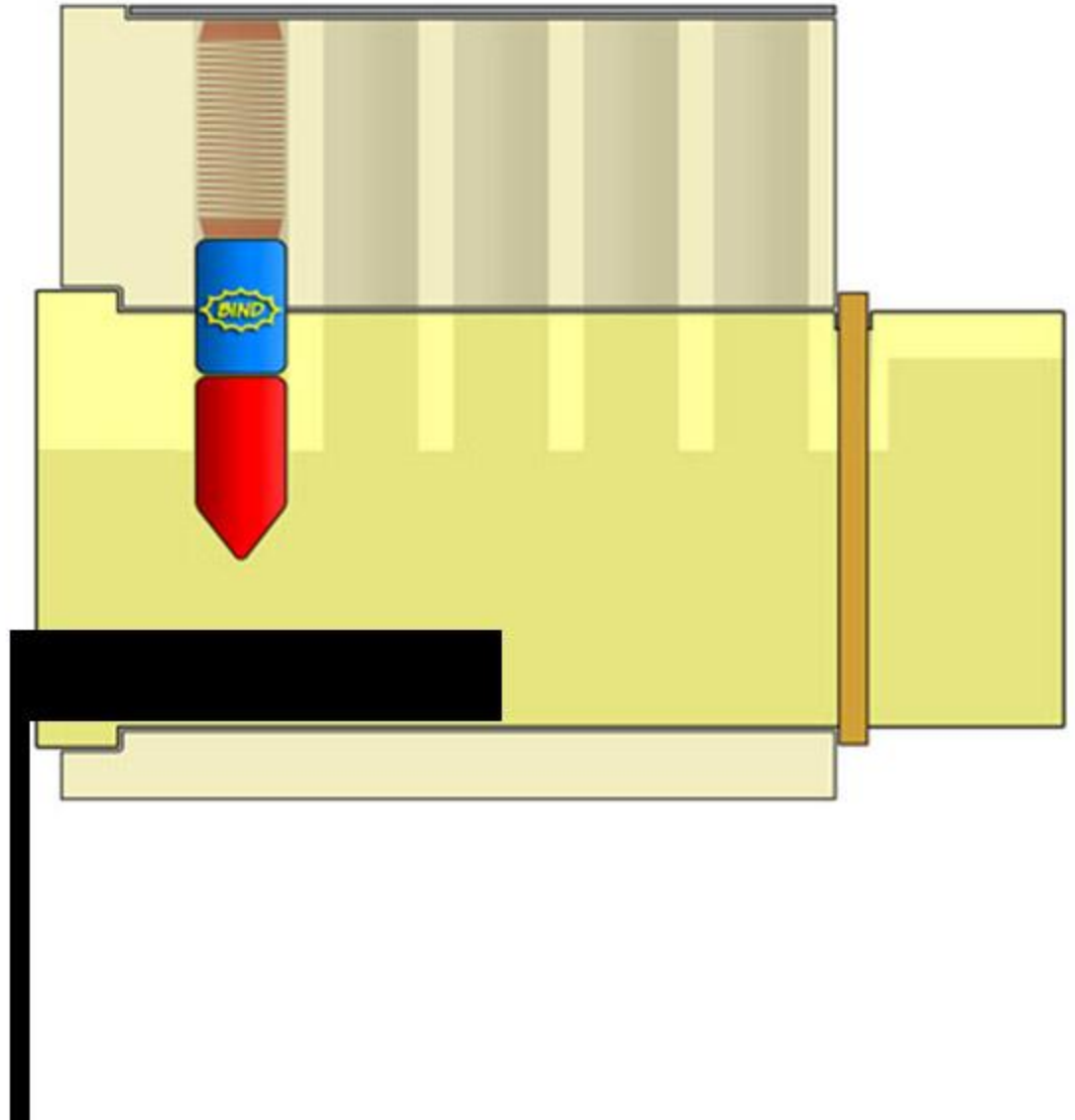

Starter Exercises

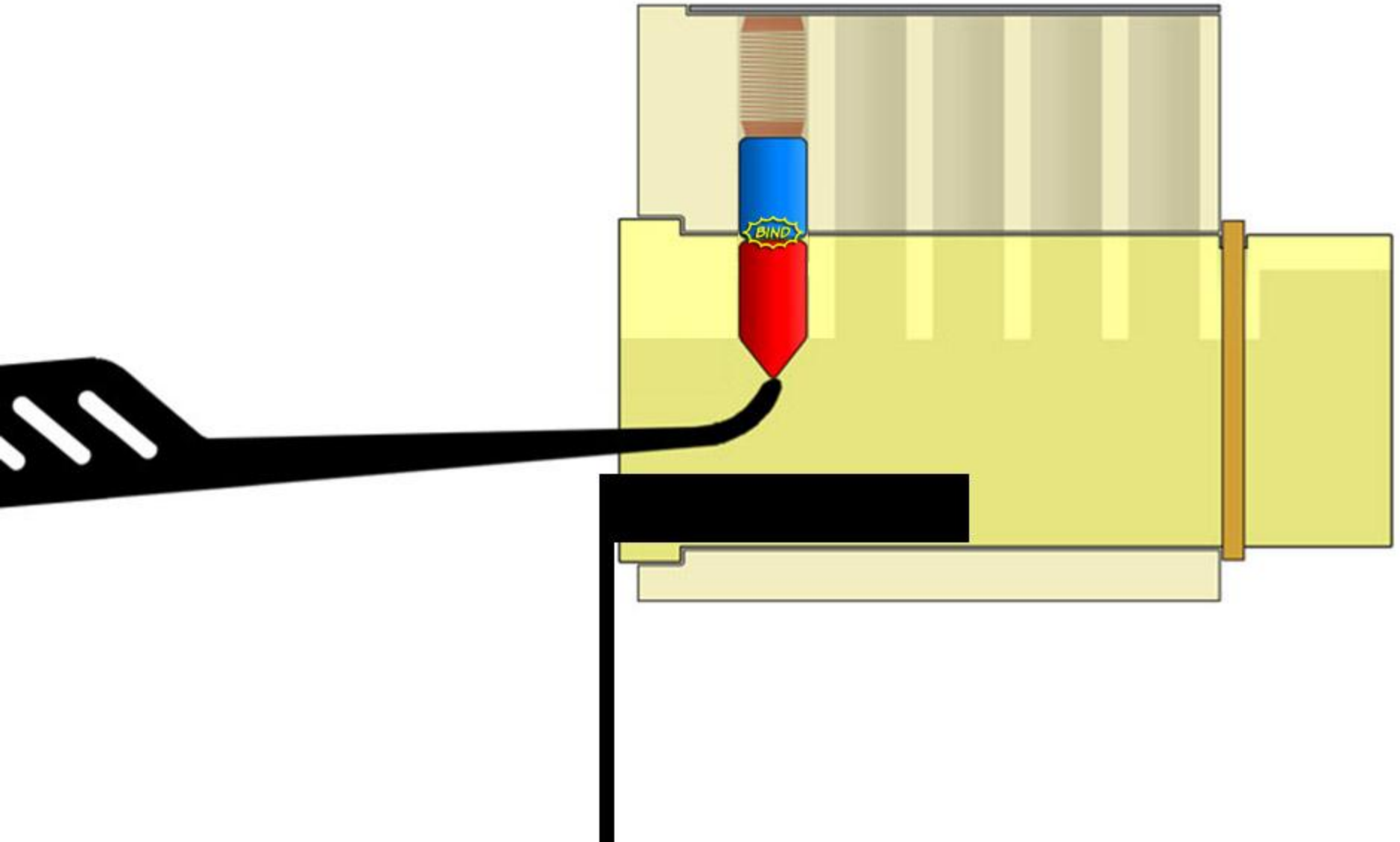

Direct Lifting

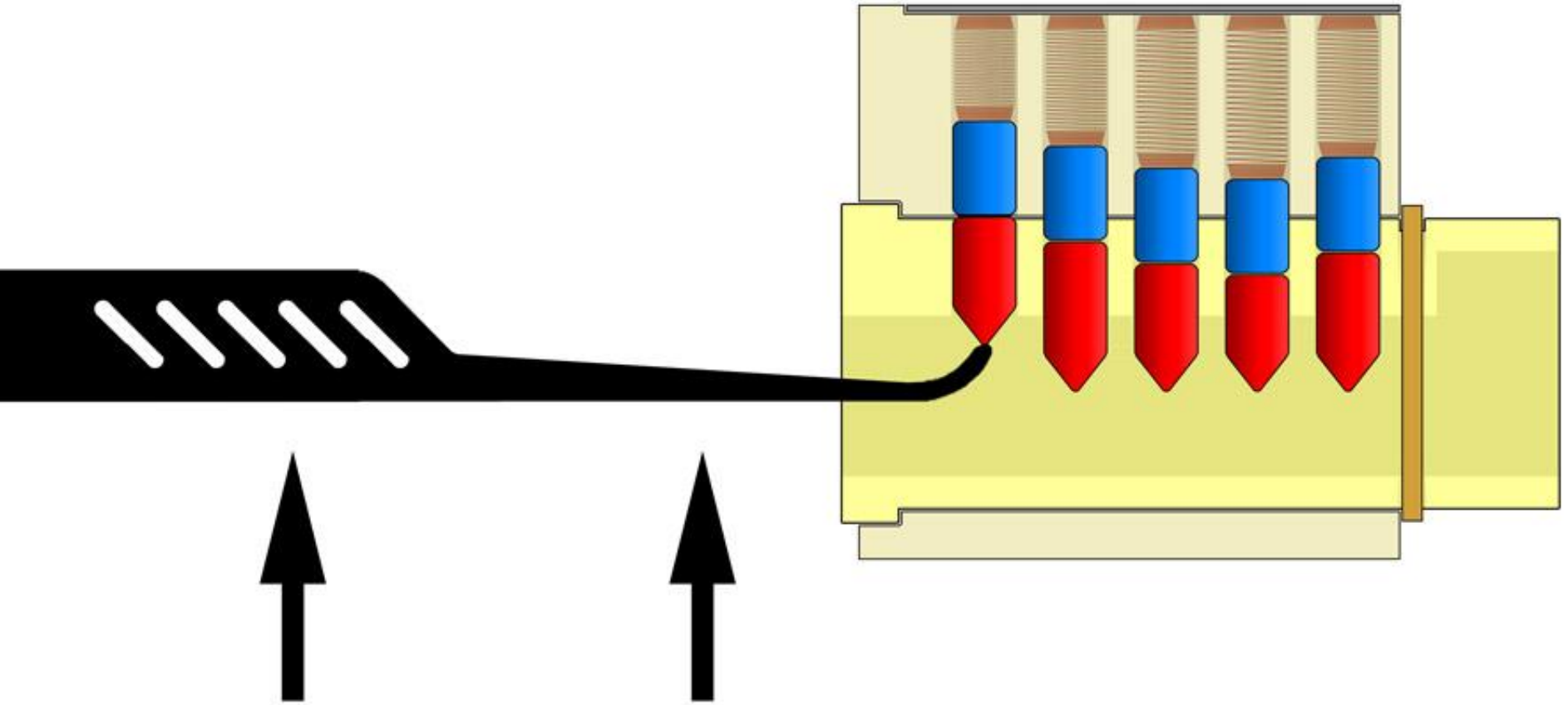

Rocking Lifting

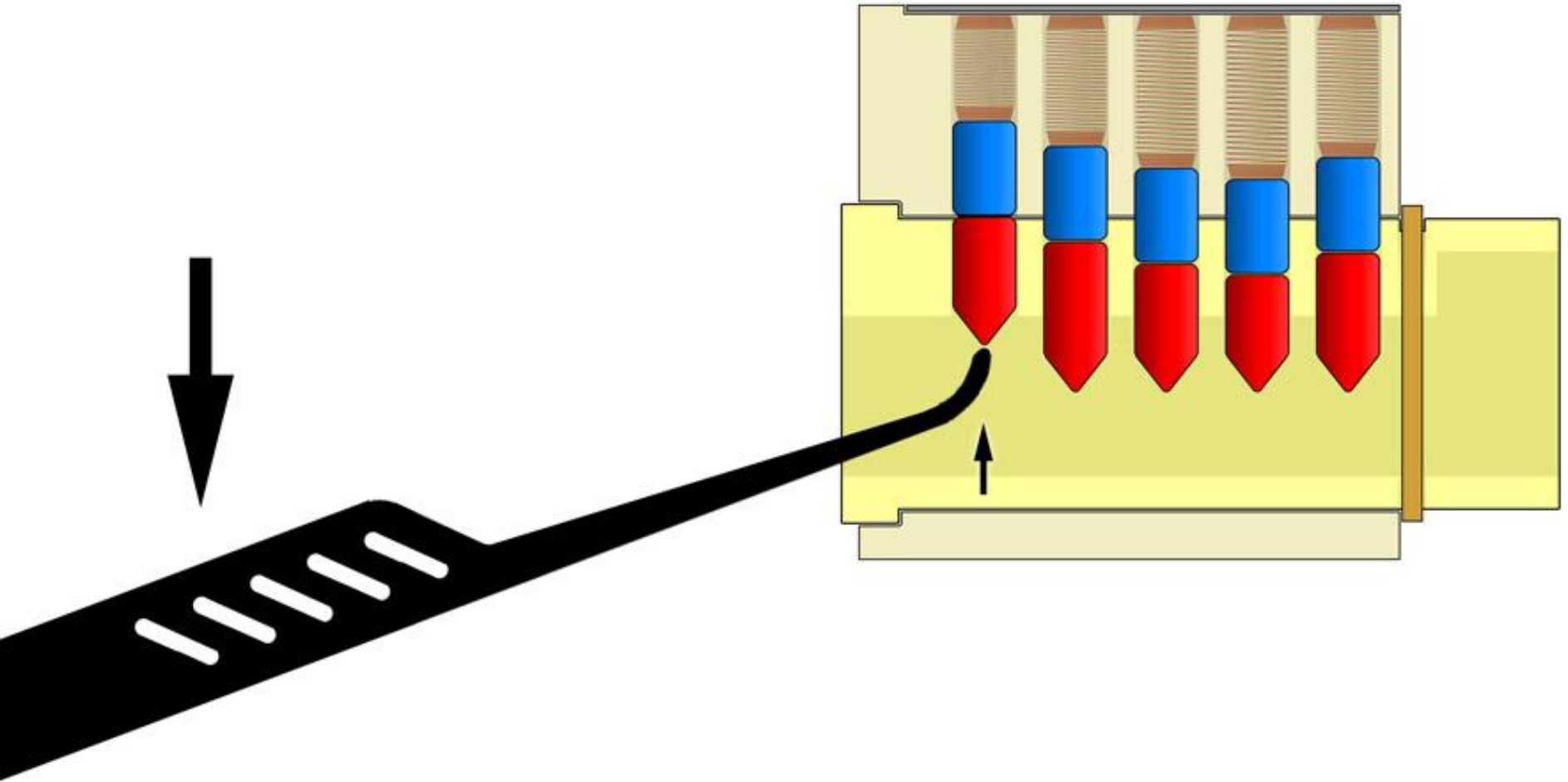

The Two Most Important Things...

RELAX



The Two Most Important Things...

OPEN!



Questions?

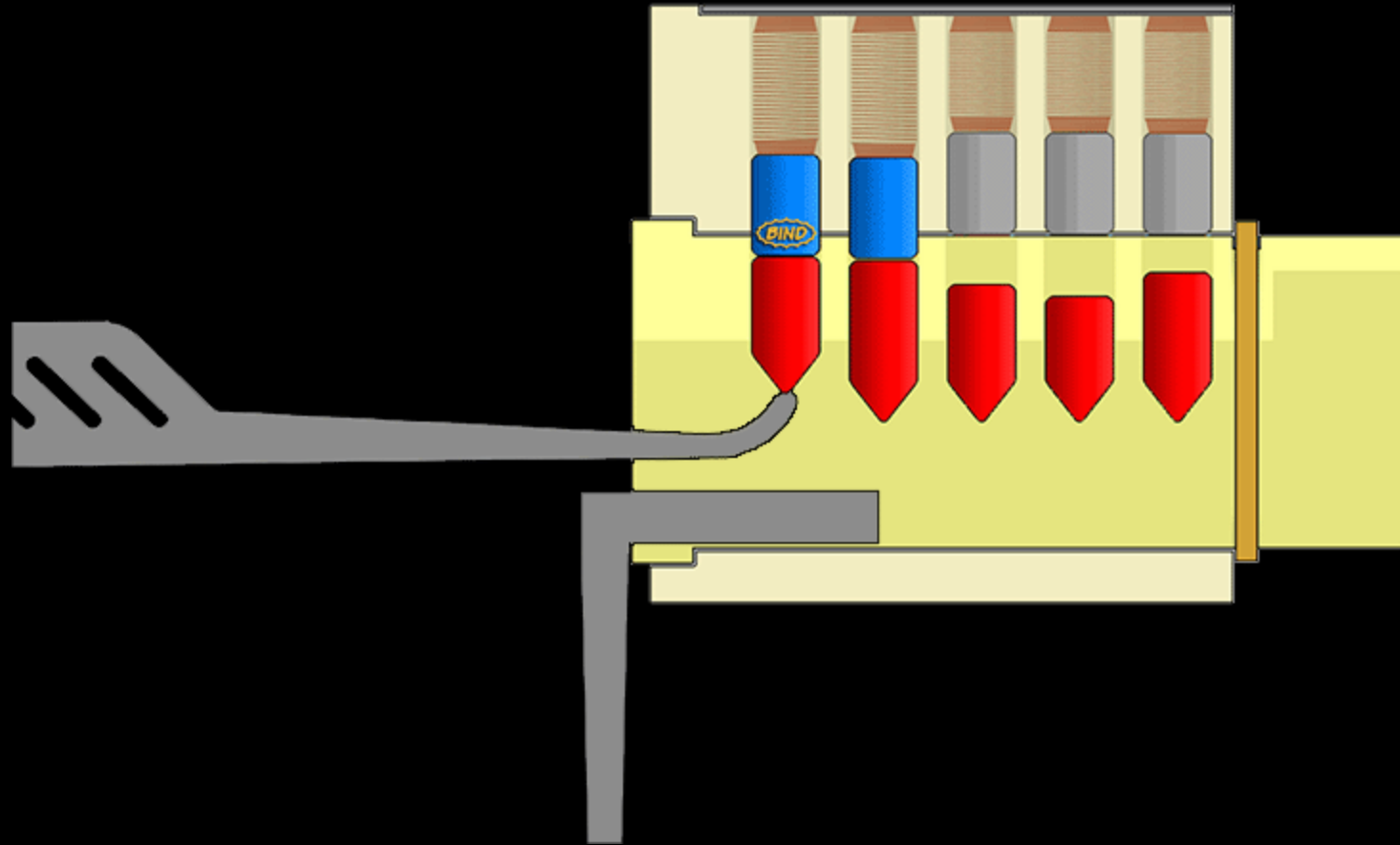

Wafer Locks

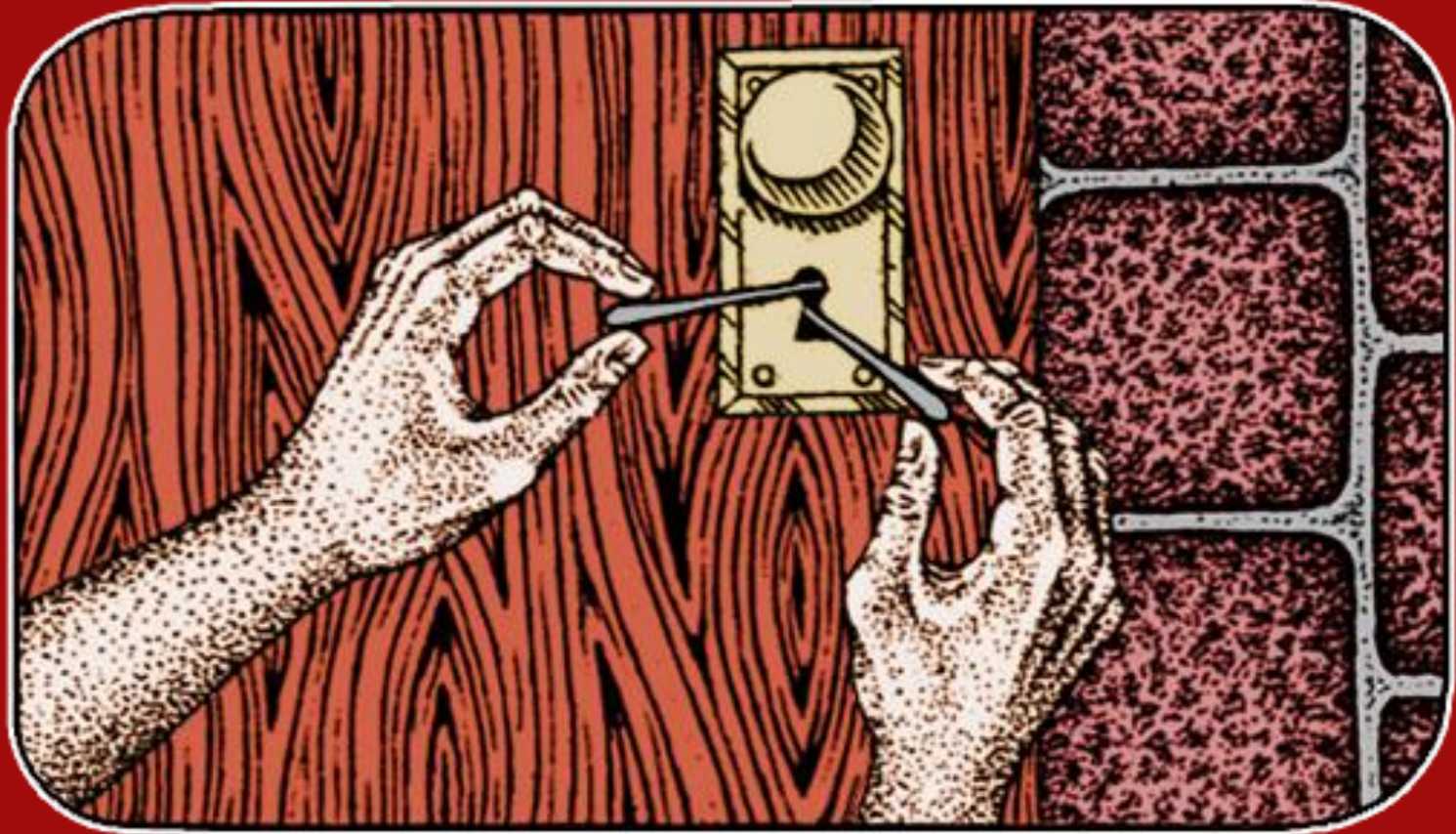

Wafer Locks



Wafer Locks



Wafer Locks - Outer View

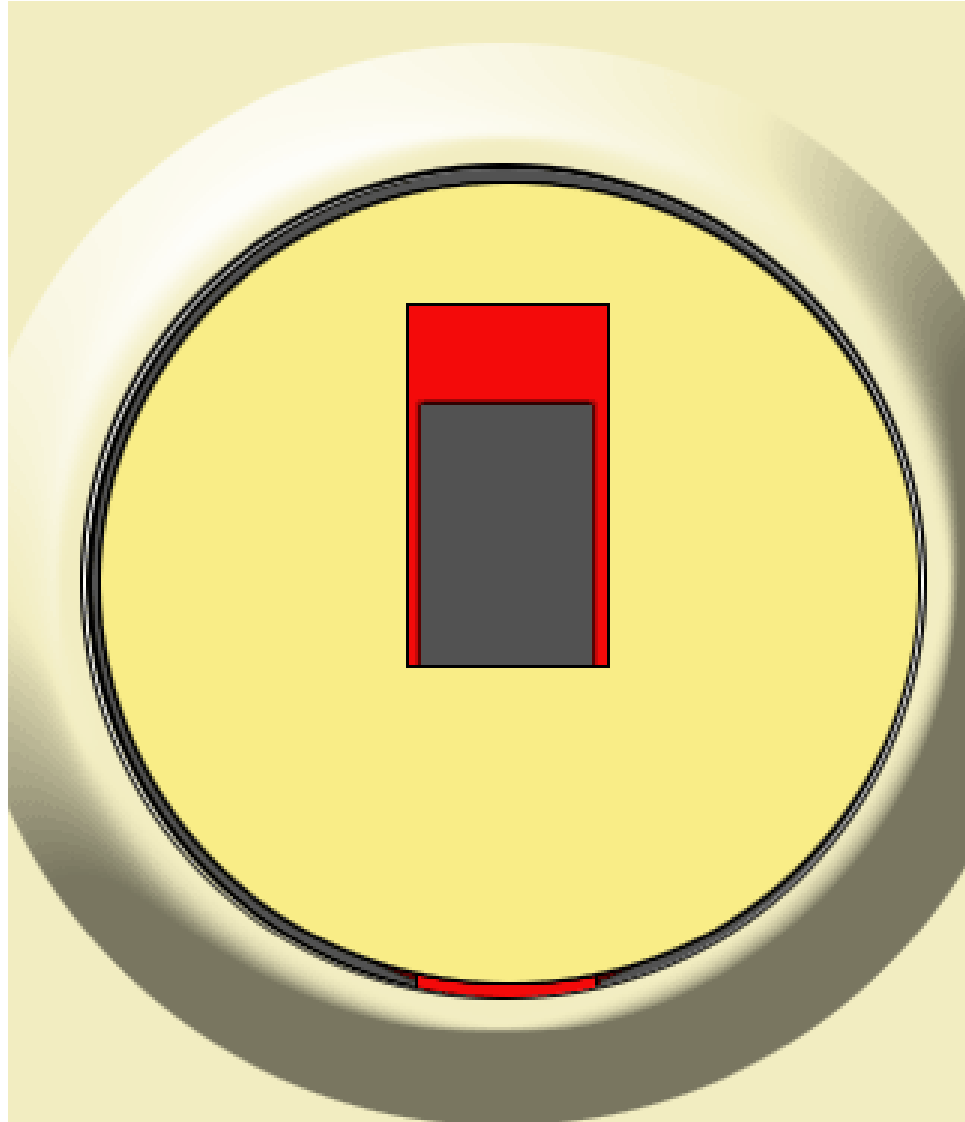

Wafer Locks - Inner View

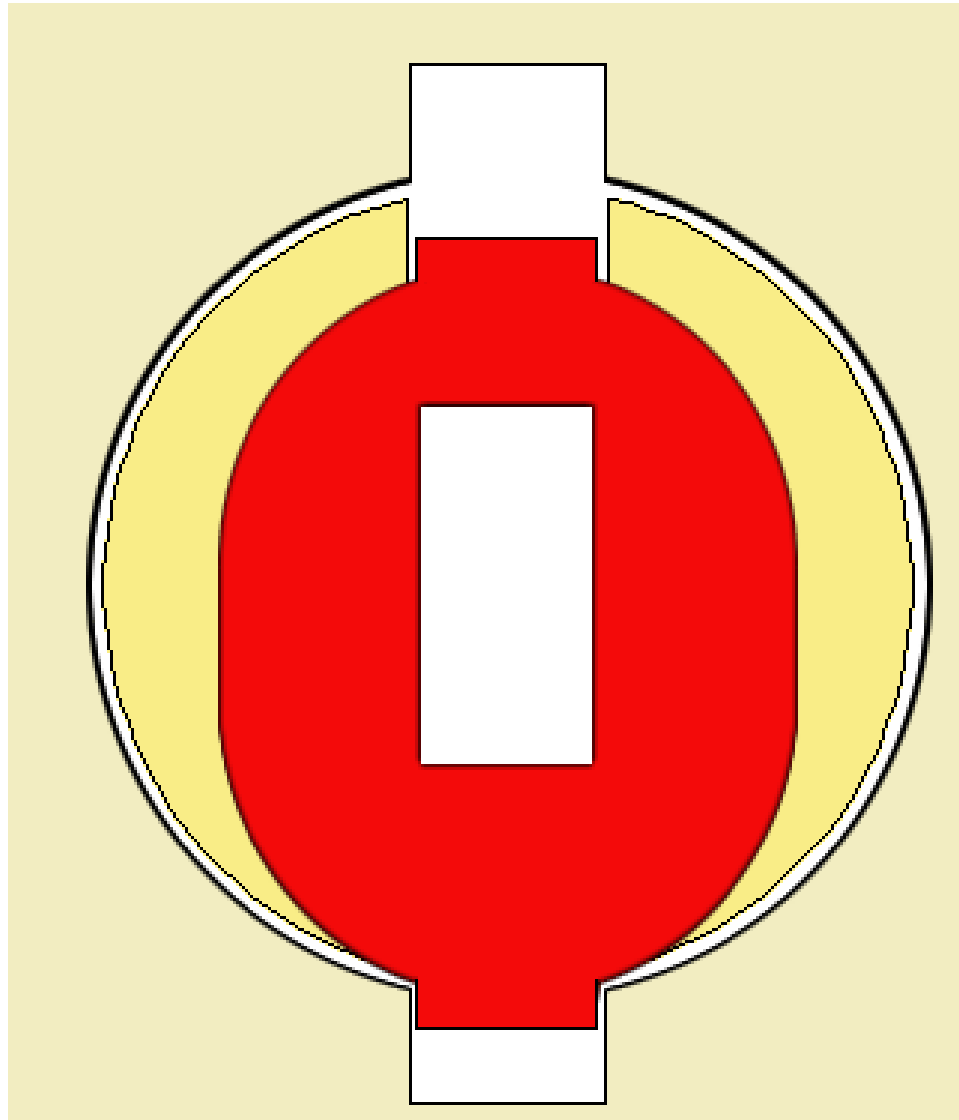

Wafer Locks - Operating Action

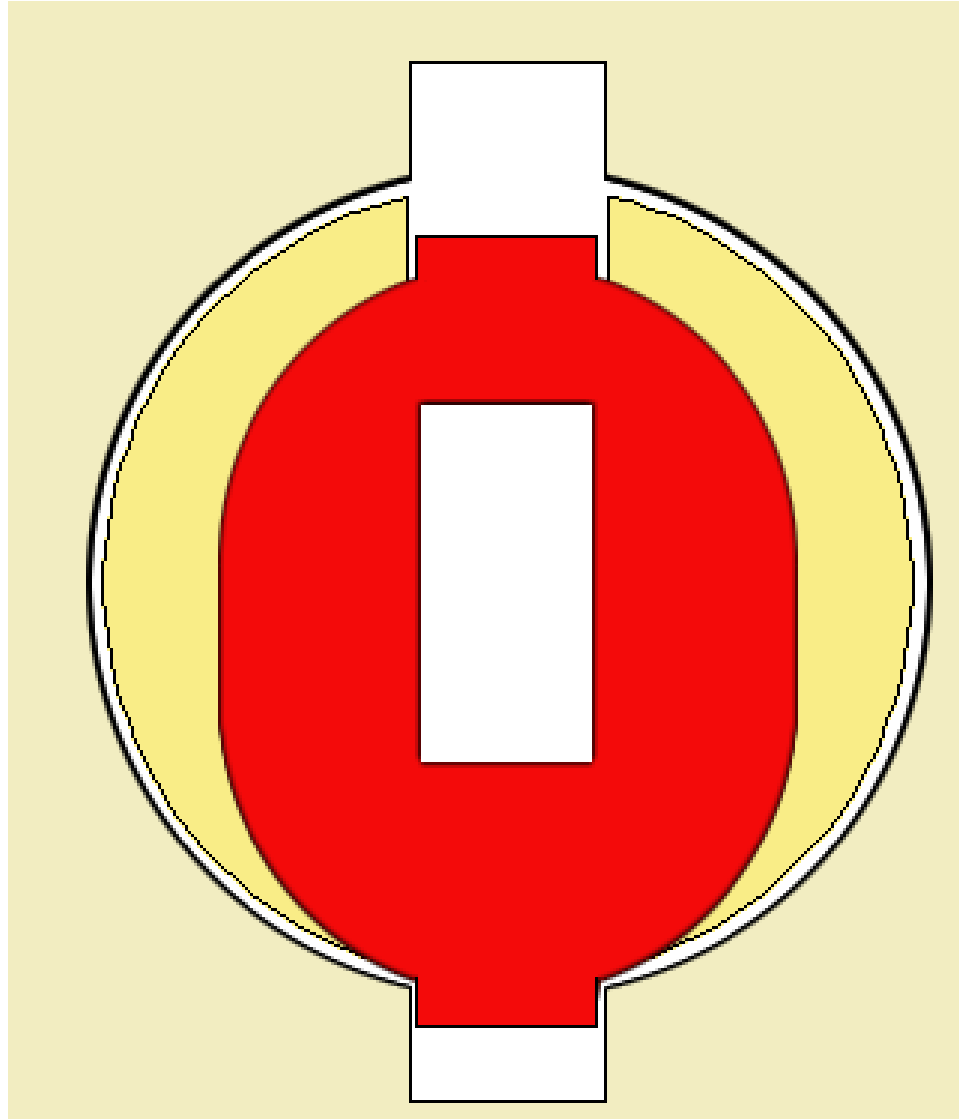

Wafer Lock Usage



Wafer Lock Usage



Wafer Lock Usage



Questions?

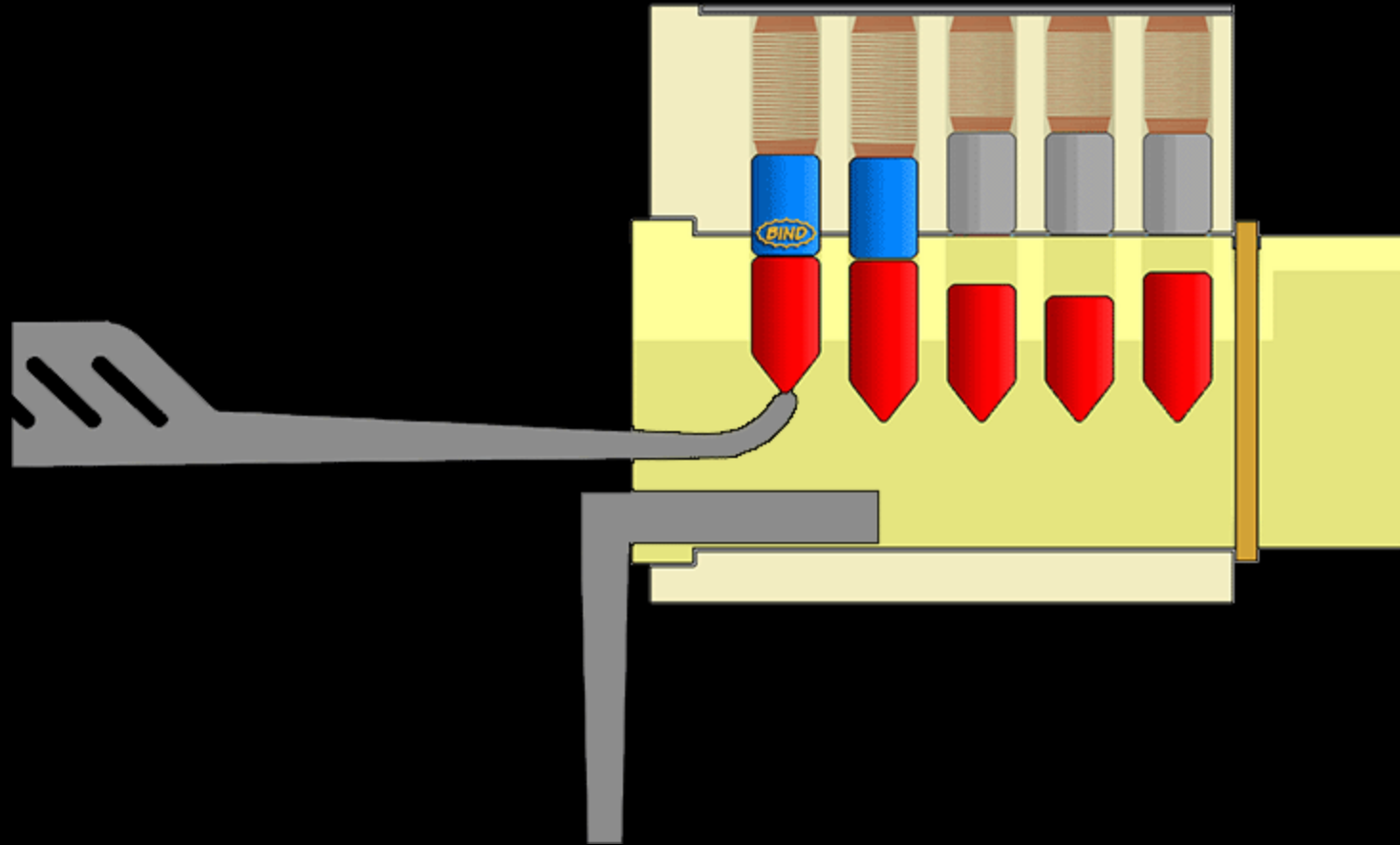

Combination Locks

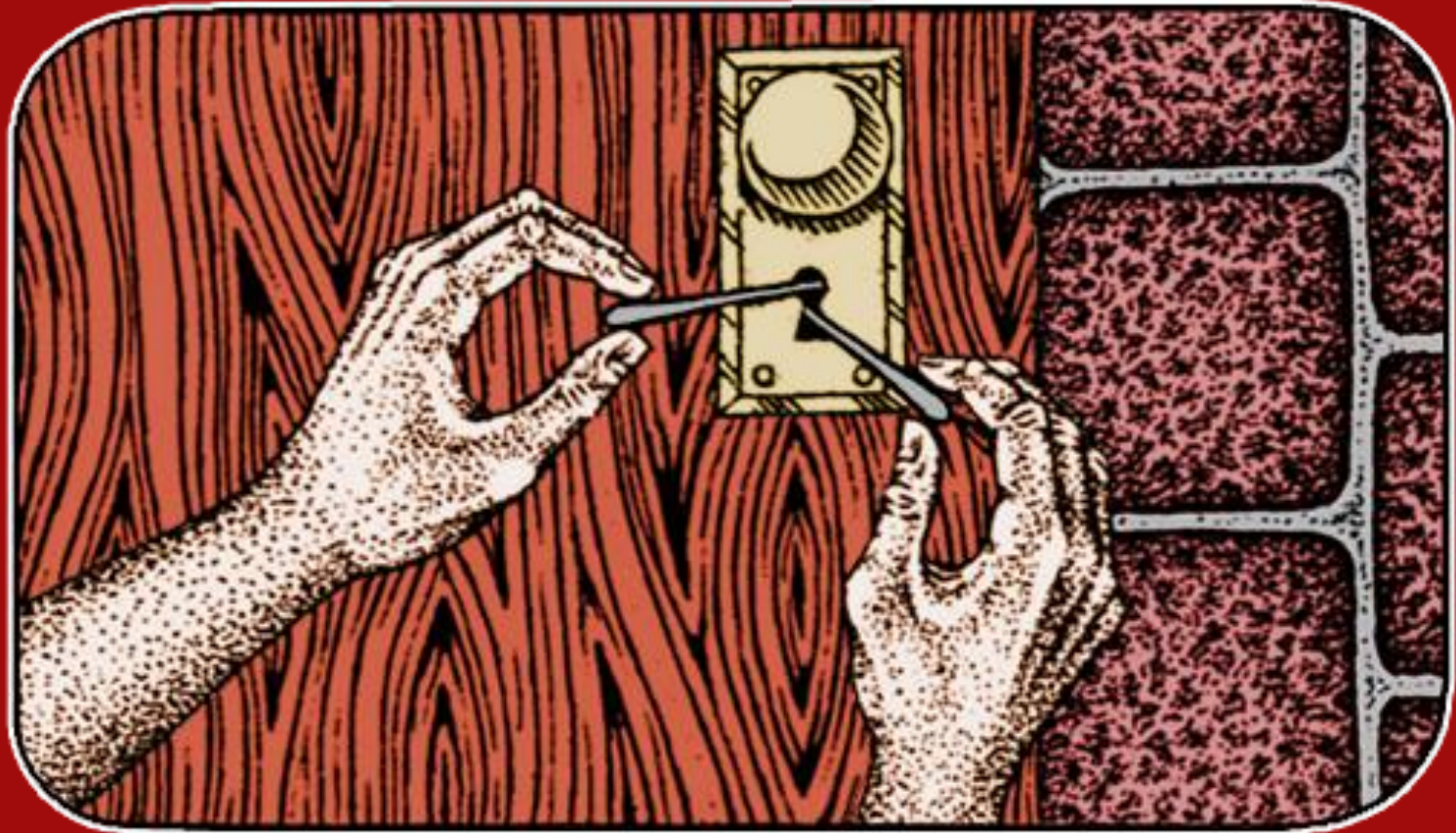

Combination Locks

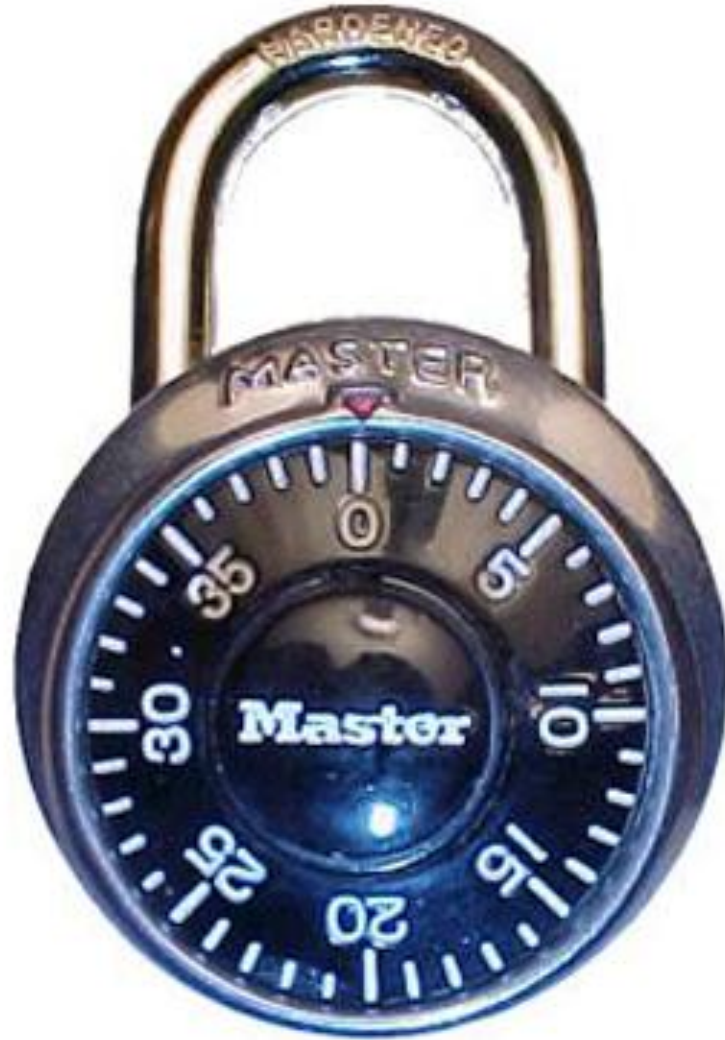

If You Are Doing This..



If You Are Doing This... .. What You Are Saving To This



Padlock Shims



Padlock Shims



Homebrew Padlock Shims



Homebrew Padlock Shims

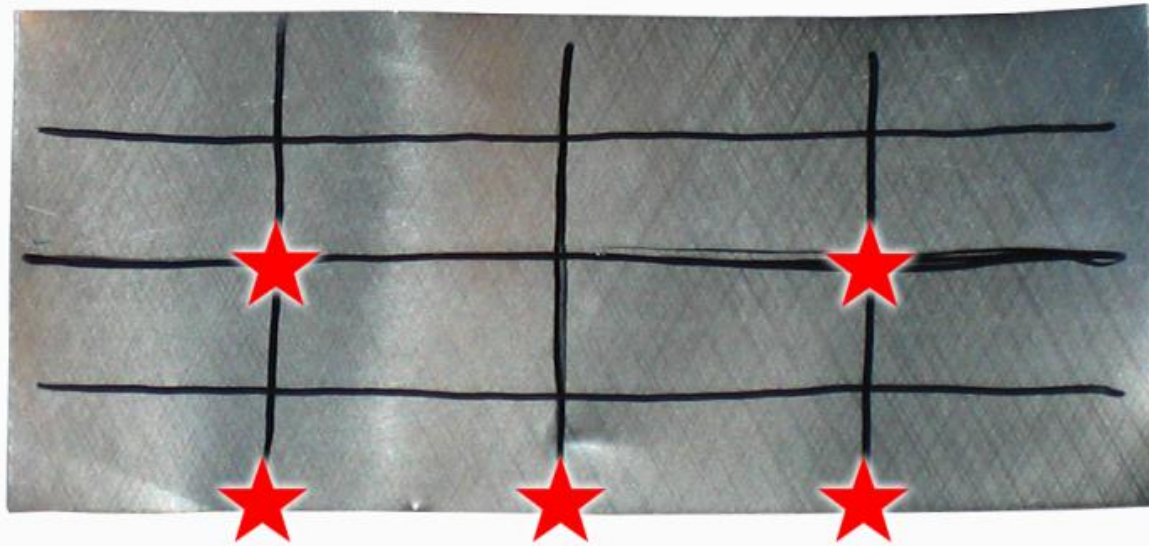

Homebrew Padlock Shims



Homebrew Padlock Shims



Homebrew Padlock Shims



Homebrew Padlock Shims



Homebrew Padlock Shims

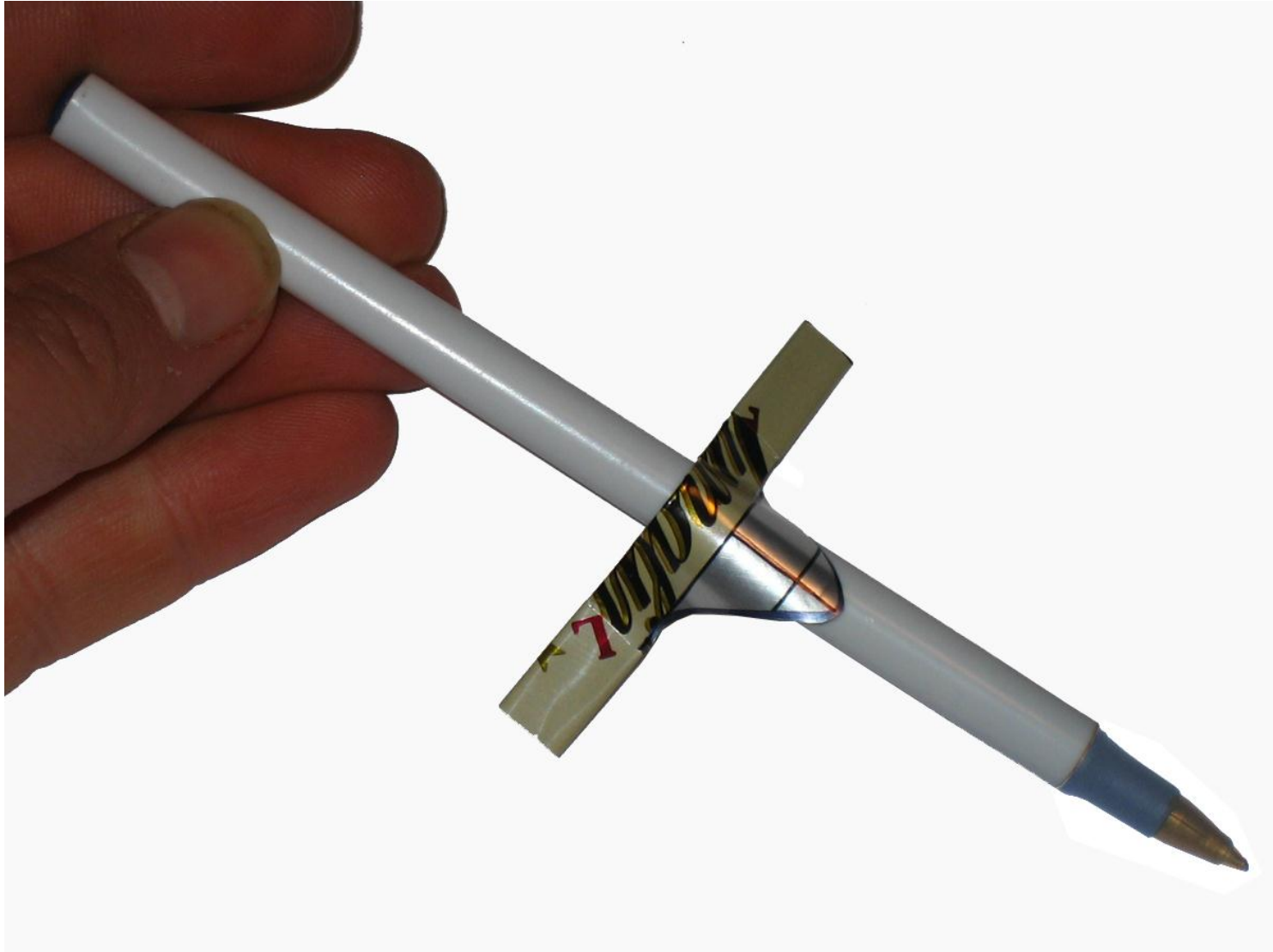

Homebrew Padlock Shims



Homebrew Padlock Shims



Homebrew Padlock Shims



Homebrew Padlock Shims



Homebrew Padlock Shims



Homebrew Padlock Shims



A tale of Homebrew Shims



A tale of Homebrew Shims



A tale of Homebrew Shims



A tale of Homebrew Shims



A tale of Homebrew Shims



Single Latch or Dual Latch ?



Shim-Proof Padlocks... Double-Ball Mechanism



Shim-Proof Padlocks... Double-Ball Mechanism



Shim-Proof Padlocks... Double-Ball Mechanism



Shim-Proof Padlocks... Double-Ball Mechanism



Some People Seemingly Don't Know Their Own Risk



Some People Seemingly Don't Know Themselves a Risk



Decoding the Combination?



Decoding the Combination

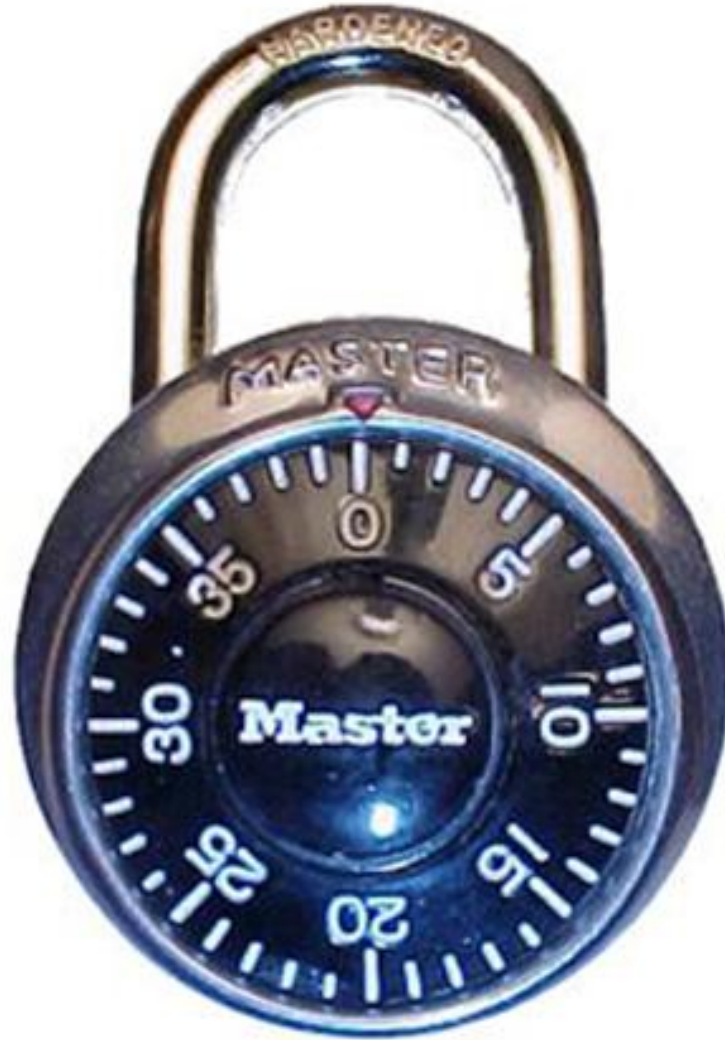

Decoding the Combination



Decoding the Combination

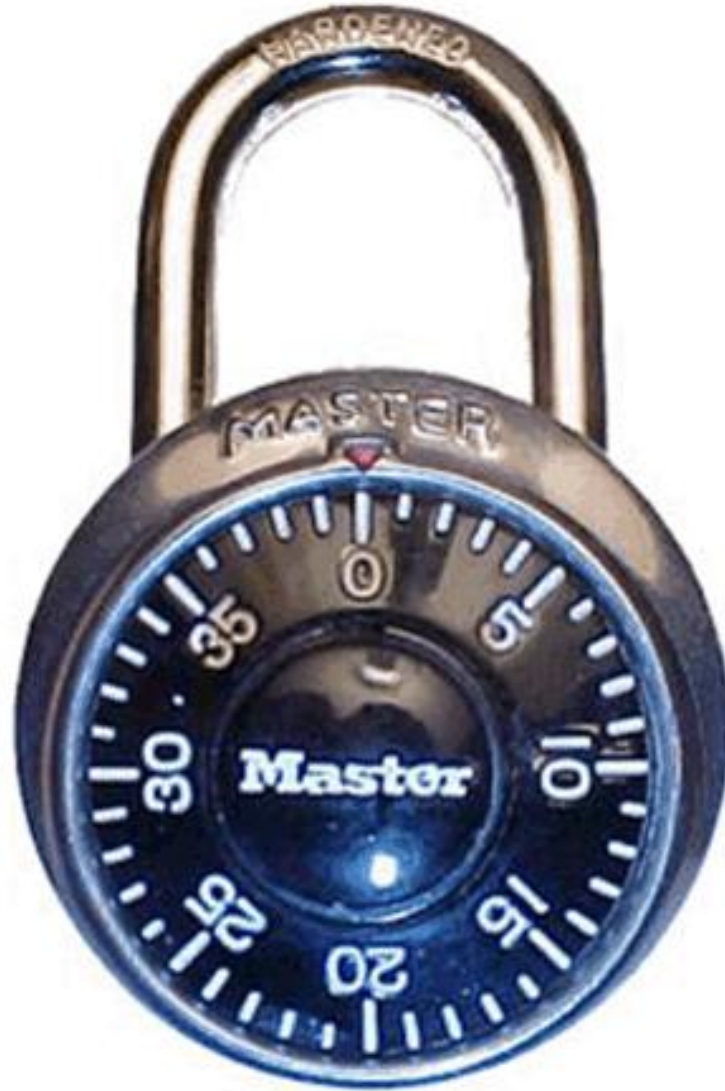

Decoding the Combination

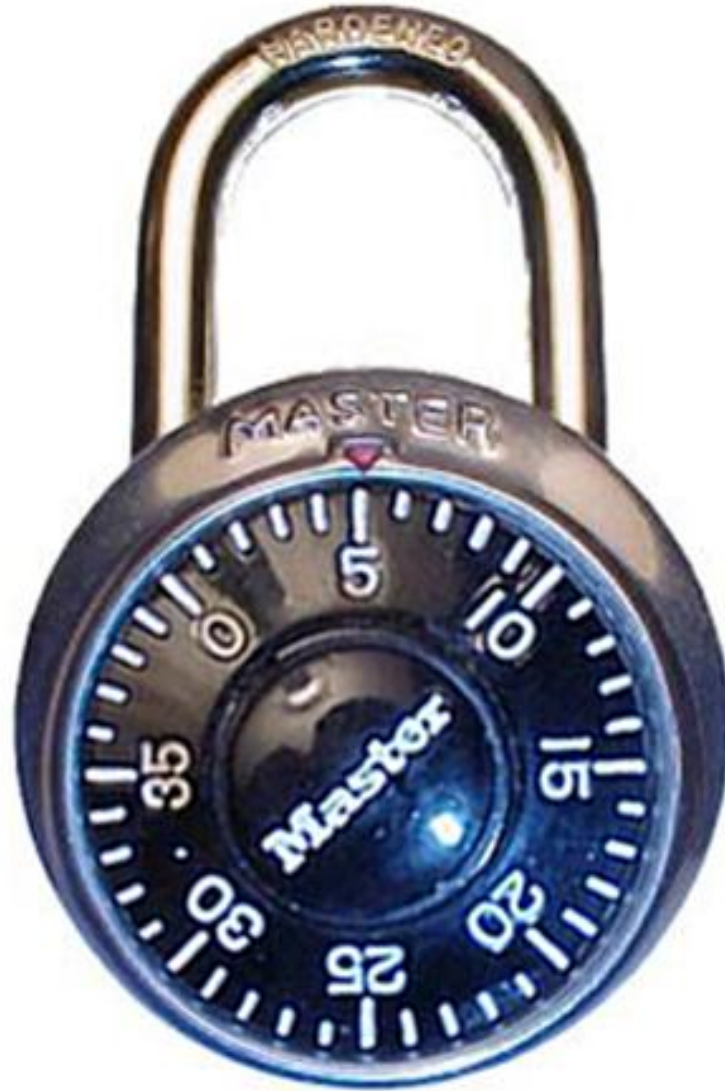

Decoding the Combination



Decoding the Combination



Decoding the Combination



Decoding the Combination



Decoding the Combination



Decoding the Combination



Decoding the Combination



Decoding the Combination

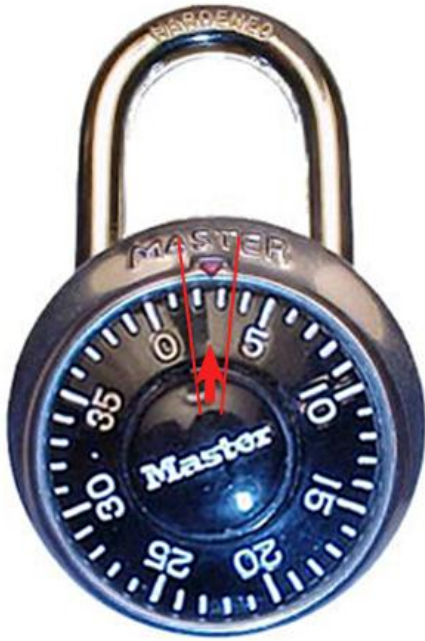

2½



12½



22½



32½

Decoding the Combination

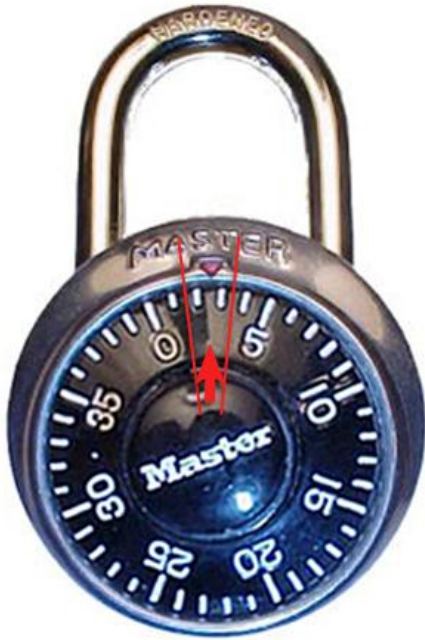

$2\frac{1}{2}$



$12\frac{1}{2}$



$22\frac{1}{2}?$



$32\frac{1}{2}$

Decoding the Combination

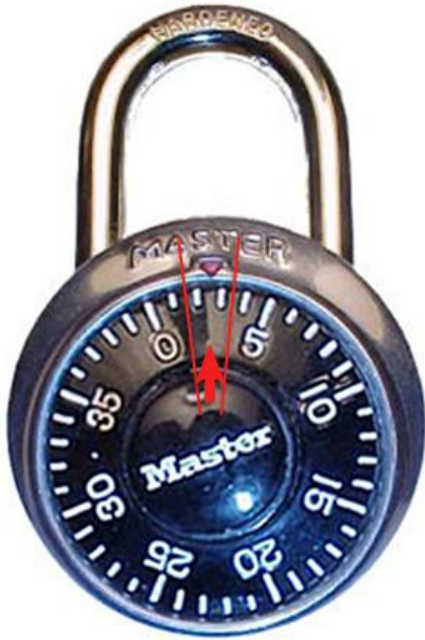

2½



12½



23 ✓



32½

Decoding the Combination



Decoding the Combination



Decoding the Combination



Decoding the Combination



Decoding the Combination

masterlock.xls [Compatibility Mode] - Microsoft Excel

File Home Insert Page Layout Formulas Data Review View Add-Ins

ThreeThird 23

	A	B	C	D	E	F	G	H	I	J
1	3rd Number	"Magic" Number	1st Number Possibilities	2nd Number Possibilities						
2	23	3	3	1						
3			7	5						
4			11	9						
5			15	13						
6			19	17						
7			23	21						
8			27	25						
9			31	29						
10			35	33						
11			39	37						
12										
13	3-1-23	15-1-23	27-1-23	39-1-23						
14	3-5-23	15-5-23	27-5-23	39-5-23						
15	3-9-23	15-9-23	27-9-23	39-9-23						
16	3-13-23	15-13-23	27-13-23	39-13-23						
17	3-17-23	15-17-23	27-17-23	39-17-23						
18	3-21-23	15-21-23	27-21-23	39-21-23						
19	3-25-23	15-25-23	27-25-23	39-25-23						
20	3-29-23	15-29-23	27-29-23	39-29-23						
21	3-33-23	15-33-23	27-33-23	39-33-23						
22	3-37-23	15-37-23	27-37-23	39-37-23						
23	7-1-23	19-1-23	31-1-23							
24	7-5-23	19-5-23	31-5-23							
25	7-9-23	19-9-23	31-9-23							
26	7-13-23	19-13-23	31-13-23							
27	7-17-23	19-17-23	31-17-23							
28	7-21-23	19-21-23	31-21-23							
29	7-25-23	19-25-23	31-25-23							
30	7-29-23	19-29-23	31-29-23							
31	7-33-23	19-33-23	31-33-23							
32	7-37-23	19-37-23	31-37-23							
33	11-1-23	23-1-23	35-1-23							
34	11-5-23	23-5-23	35-5-23							
35	11-9-23	23-9-23	35-9-23							
36	11-13-23	23-13-23	35-13-23							
37	11-17-23	23-17-23	35-17-23							
38	11-21-23	23-21-23	35-21-23							
39	11-25-23	23-25-23	35-25-23							
40	11-29-23	23-29-23	35-29-23							
41	11-33-23	23-33-23	35-33-23							
42	11-37-23	23-37-23	35-37-23							
43										

Ready

<http://deviating.net/lockpicking/media/masterlock.xls>

Decoding Multi-Wheel Combinations



A New Kind of Combination Padlock



A New Kind of Combination

Padlock



A New Kind of Combination

Padlock



A New Kind of Combination

Padlock



A New Kind of Combination

Padloc

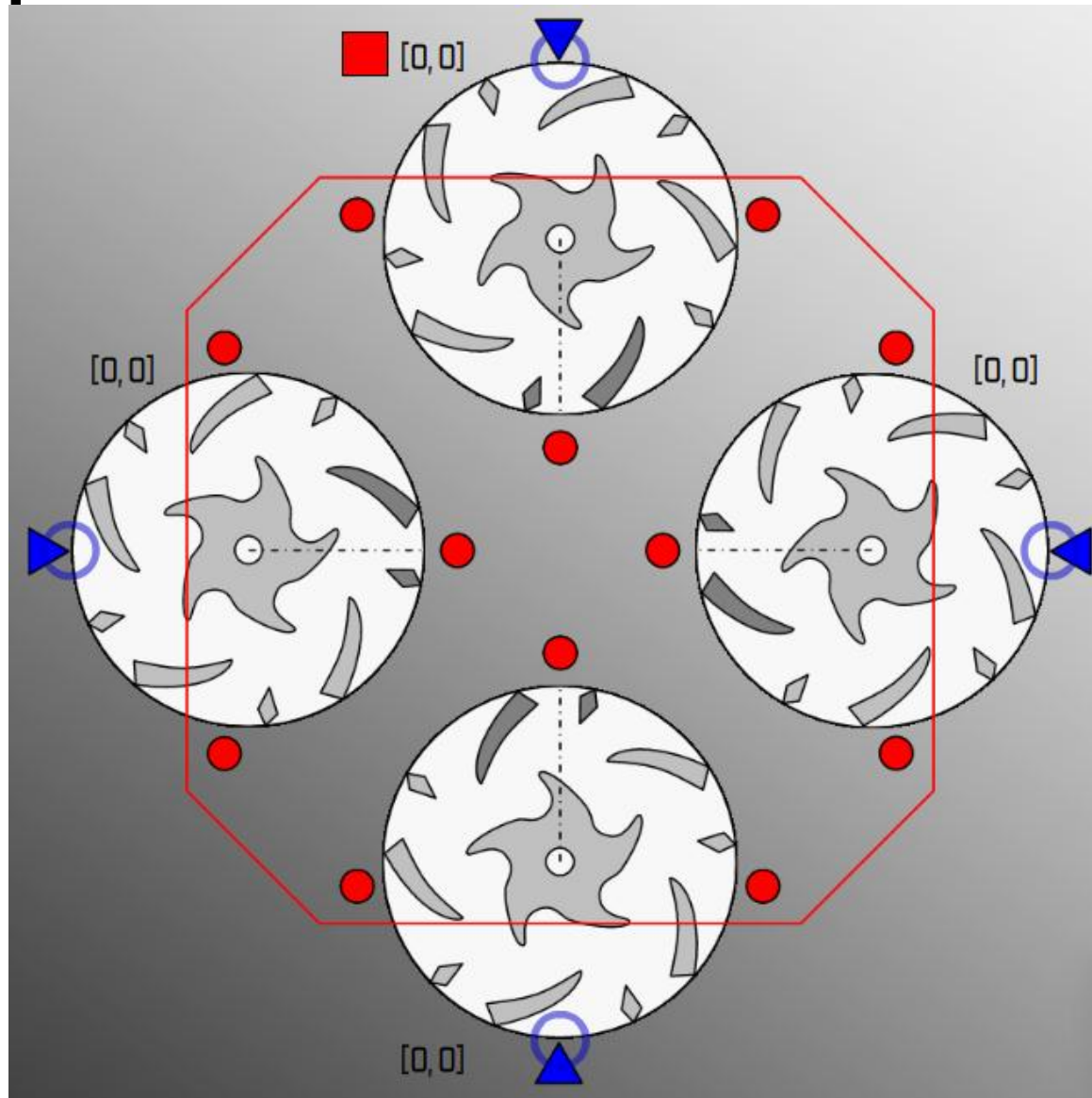

Questions?

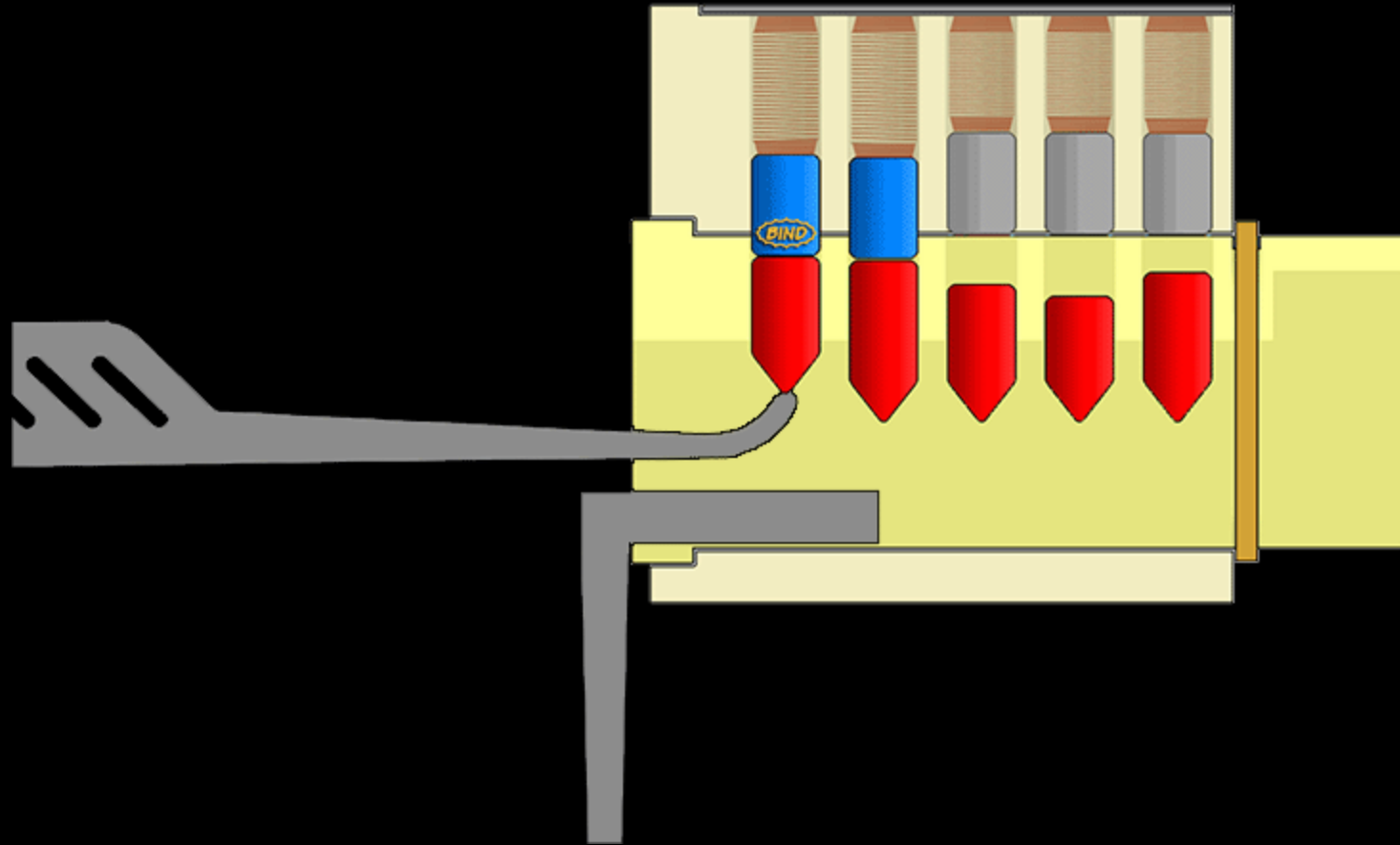

Pick-Resistant Locks

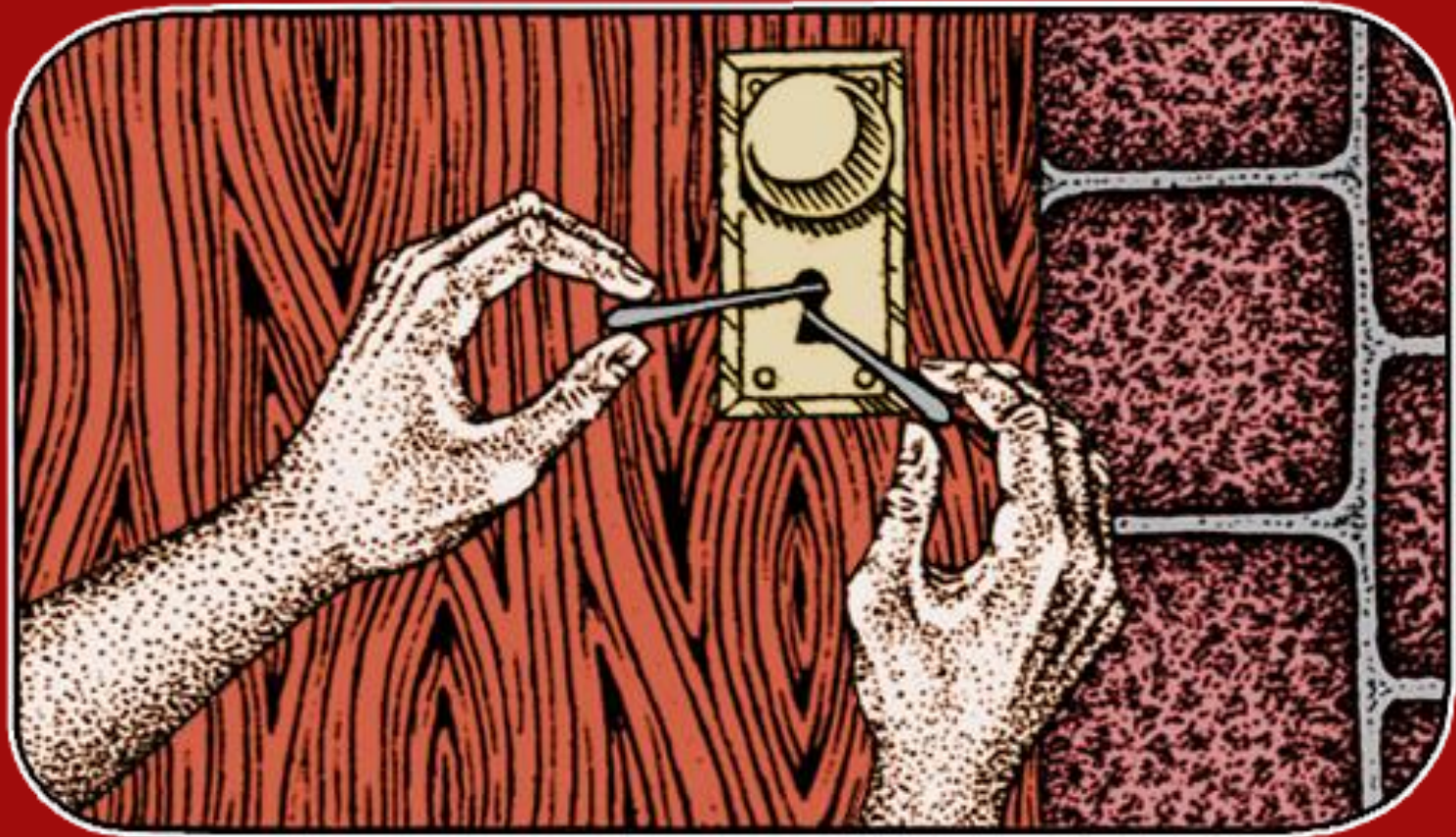

Pick-Resistant Keyways

Simple...

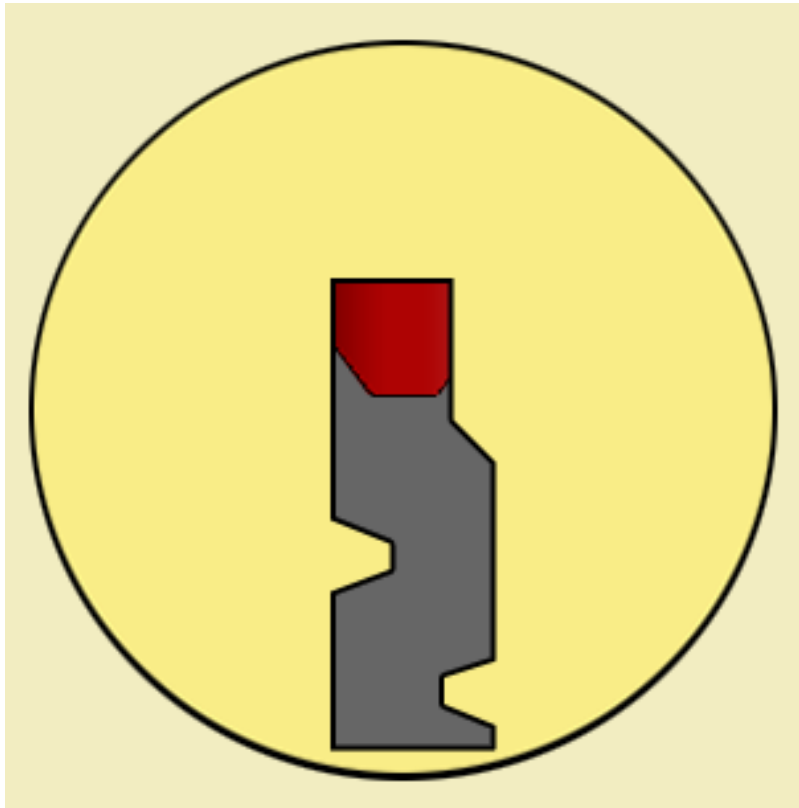

straight and wide

Pick-Resistant Keyways

Simple...

Medium...

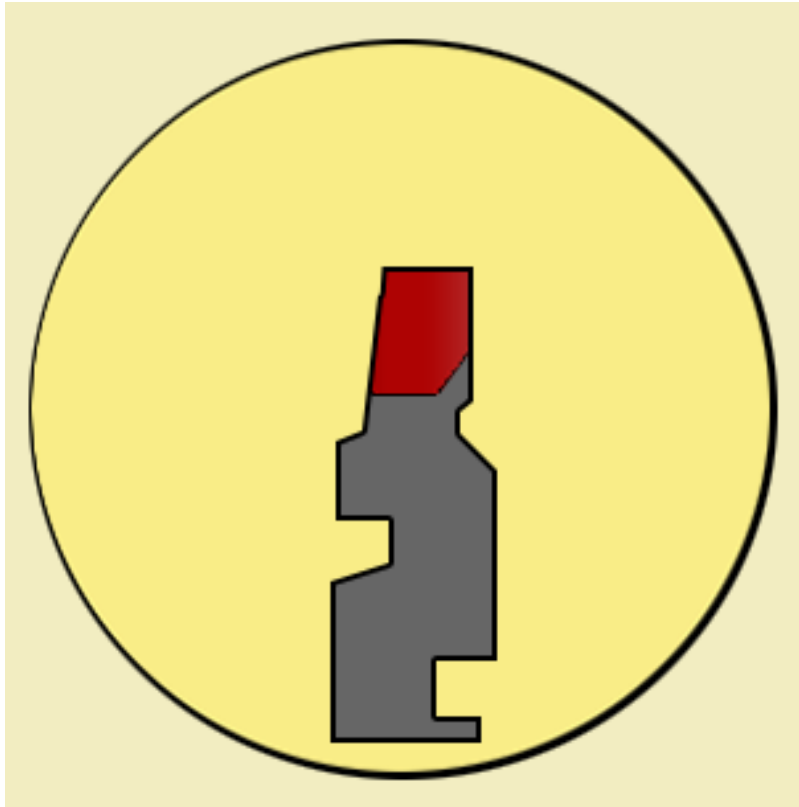

aight and wide

ght but narrow

Pick-Resistant Keyways

Simple...

Medium...

Complex...

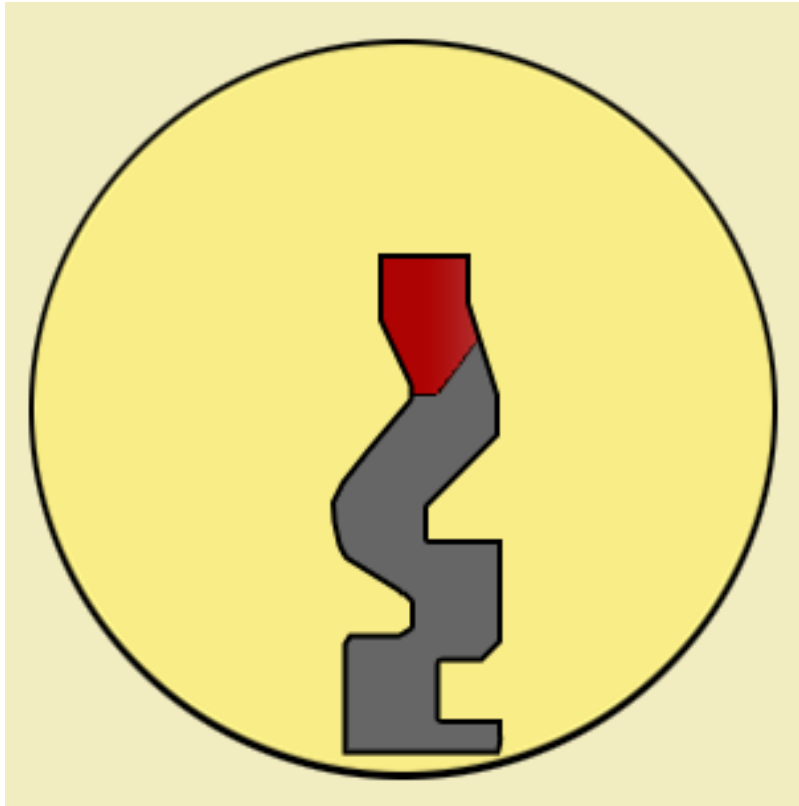

straight and wide

straight but narrow

thinner and curvy

Pick-Resistant Keyways

Simple...

Medium...

Complex...

Hard...

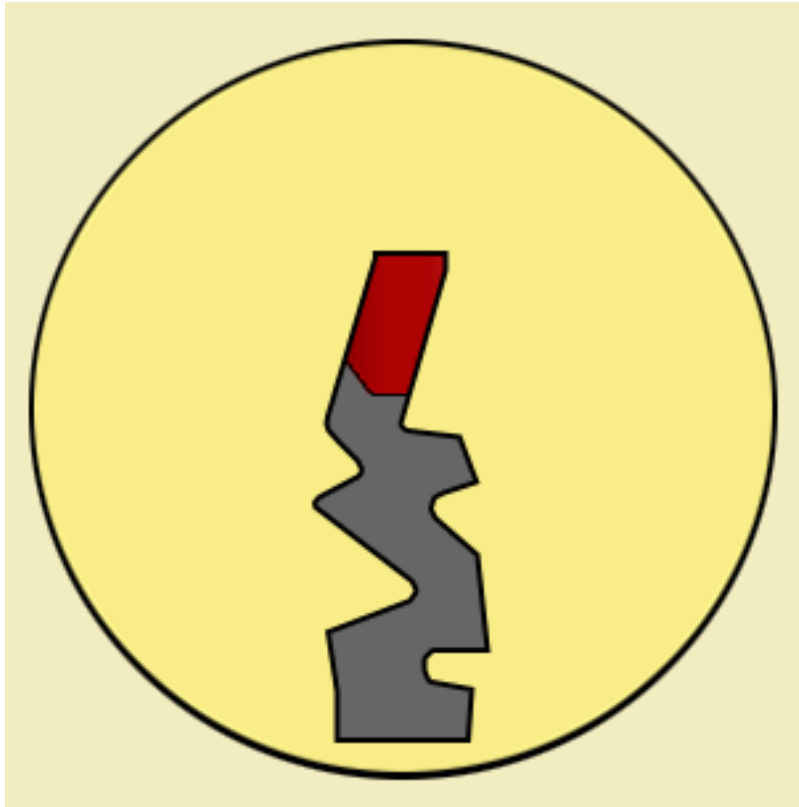

straight and wide

slight but narrow

thinner and curvy

lots of angles

Pick-Resistant Keyways

Simple...

... straight and wide

Medium...

... straight but narrow

Complex...

... thinner and curvy

Hard...

... lots of angles

Fiendish...

... overlapping wards

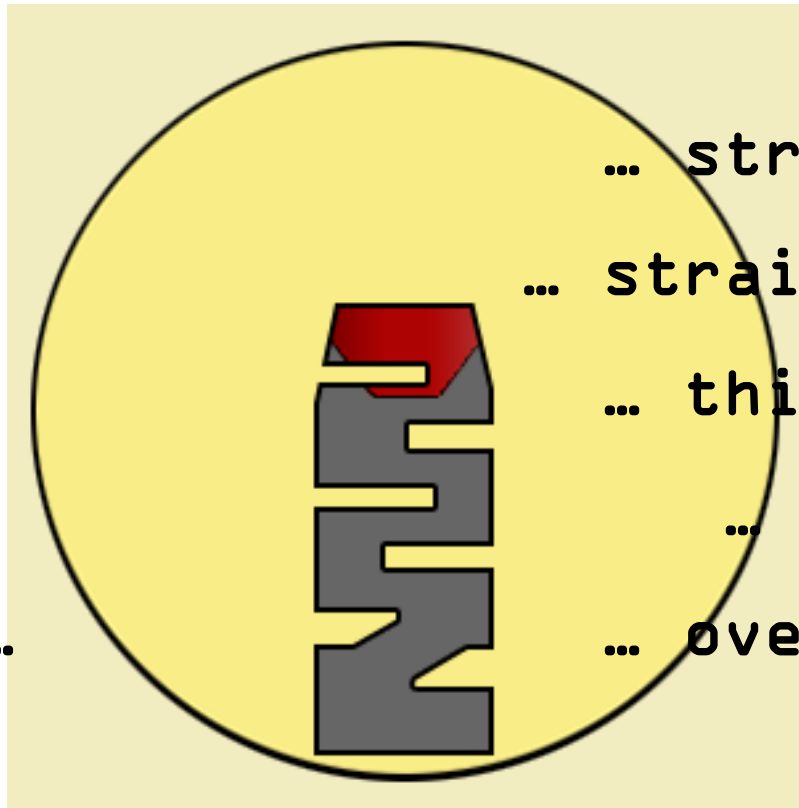

Pick-Resistant Pins

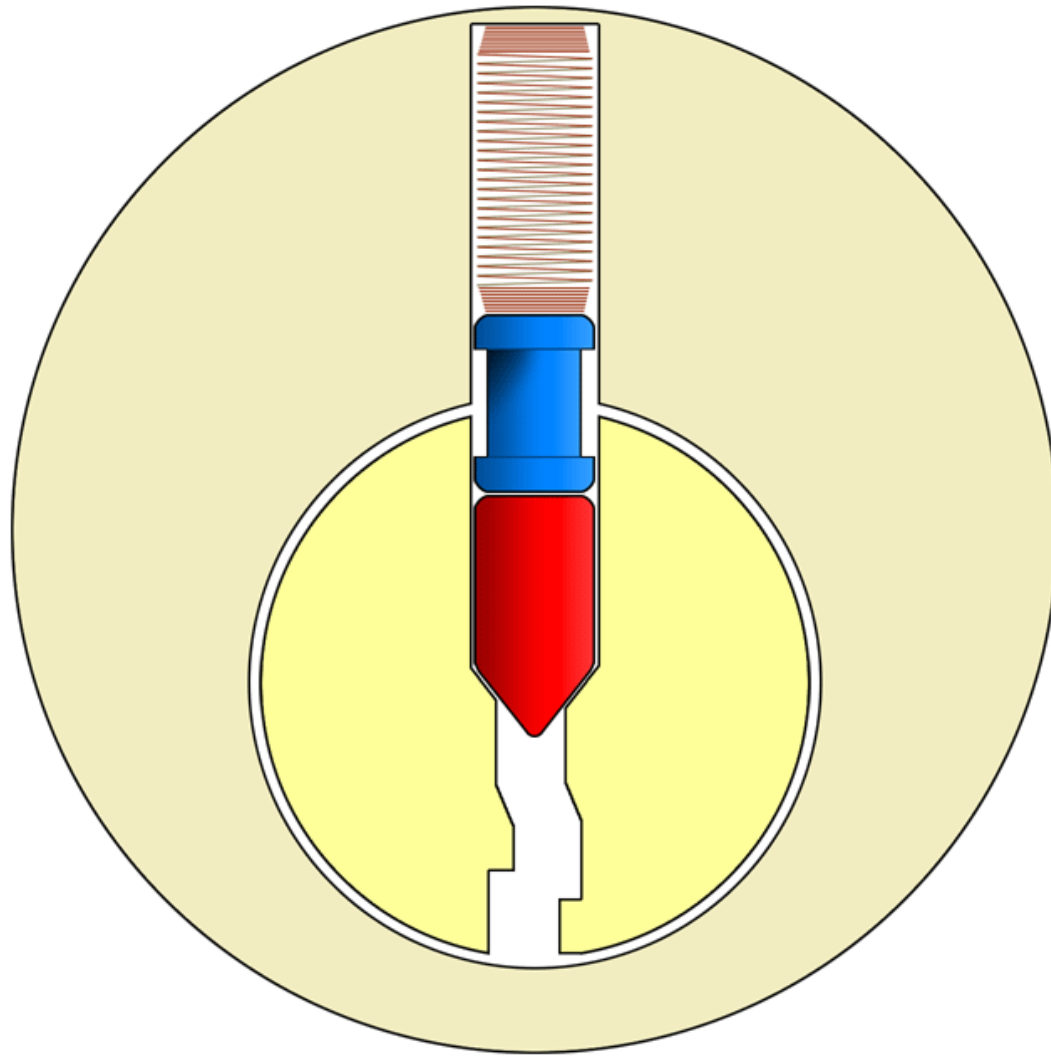

Pick-Resistant Pins - Spool Pin

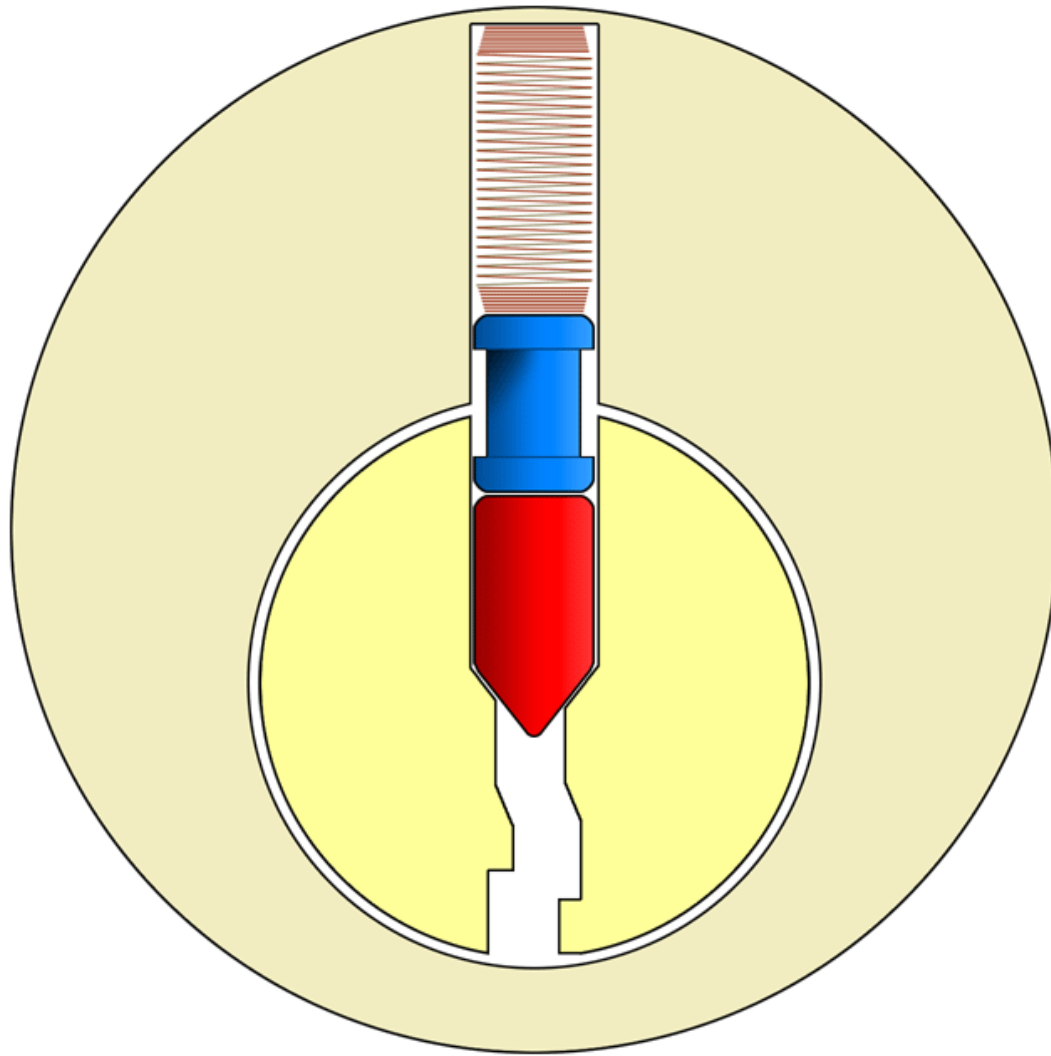

Pick-Resistant Pins - Spool Pin Binding

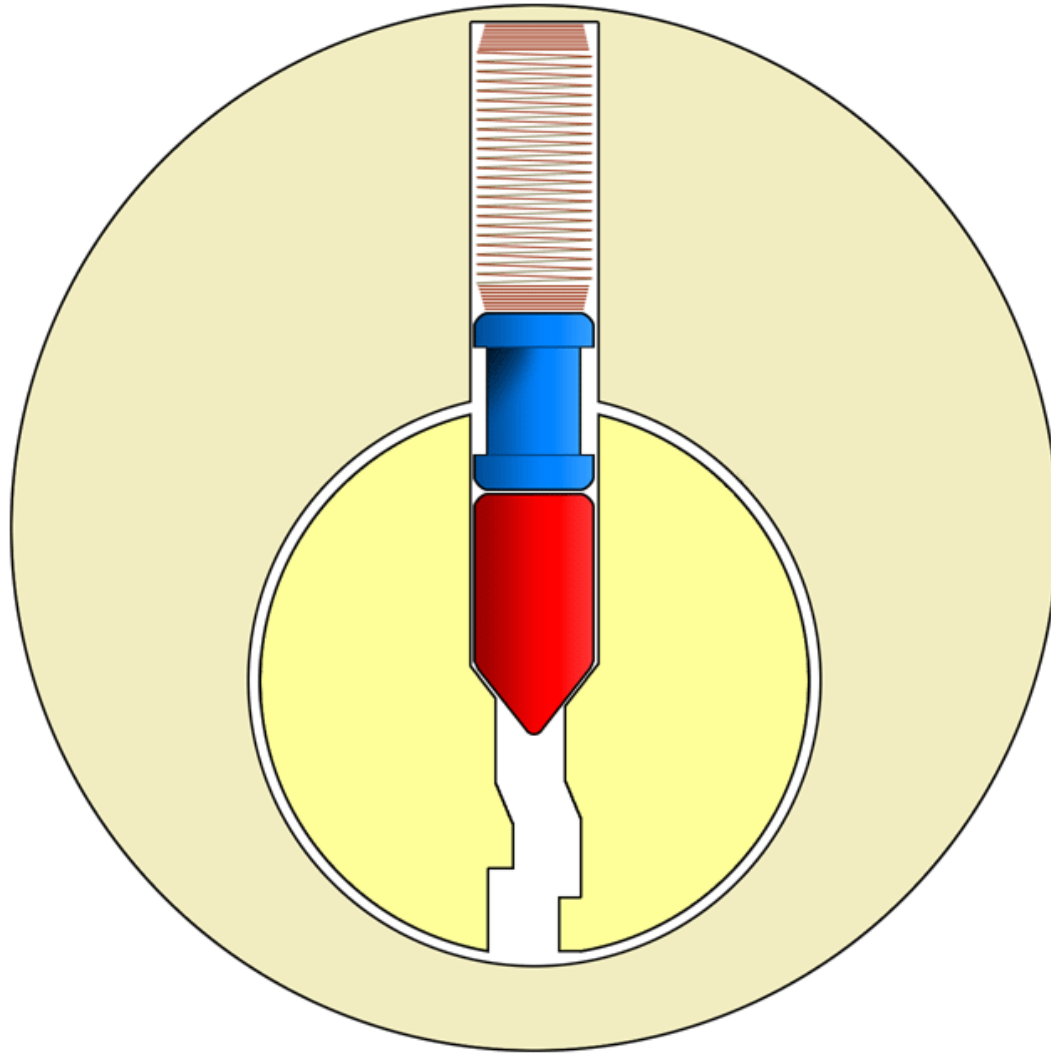

Pick-Resistant Pins - Spool Pin

Pickin[™]

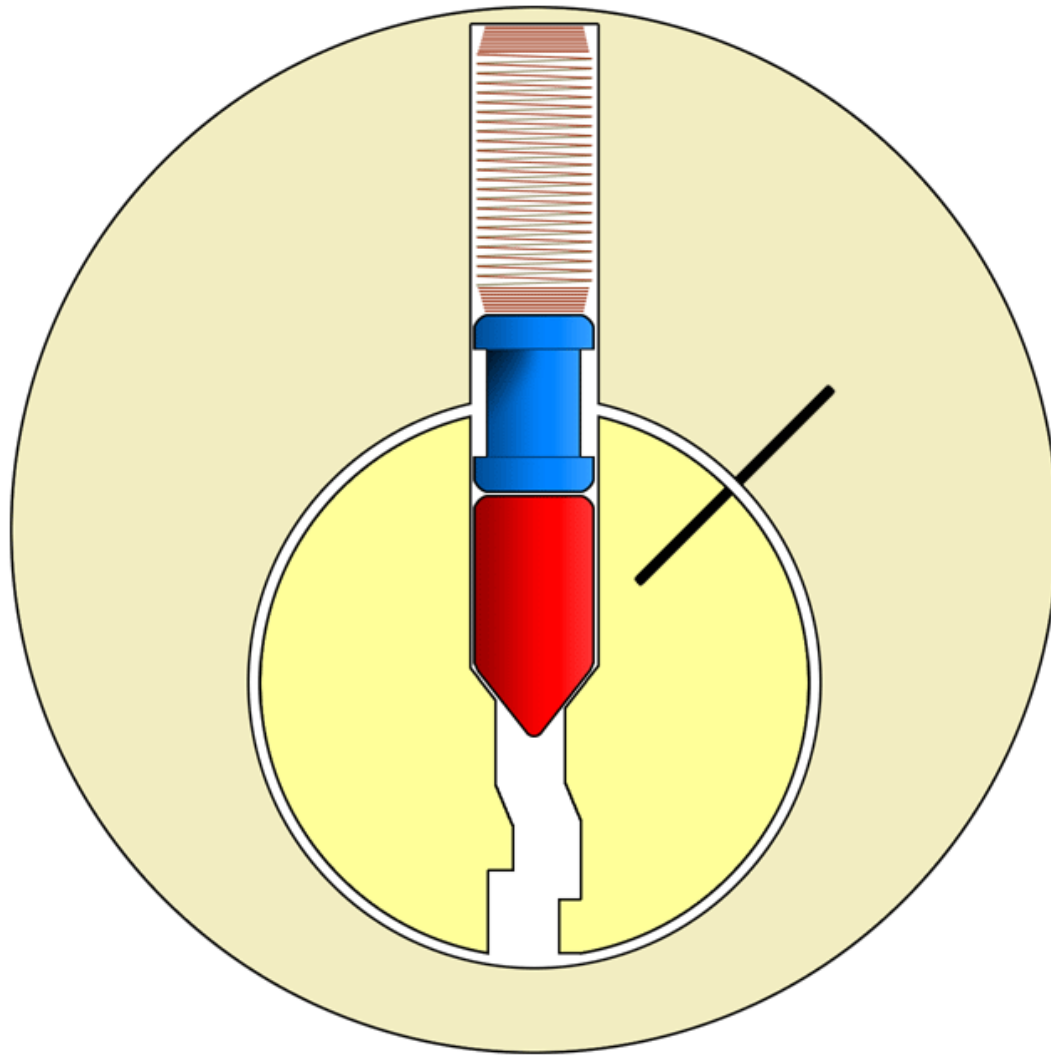

Pick-Resistant Pins - Mushroom Pin

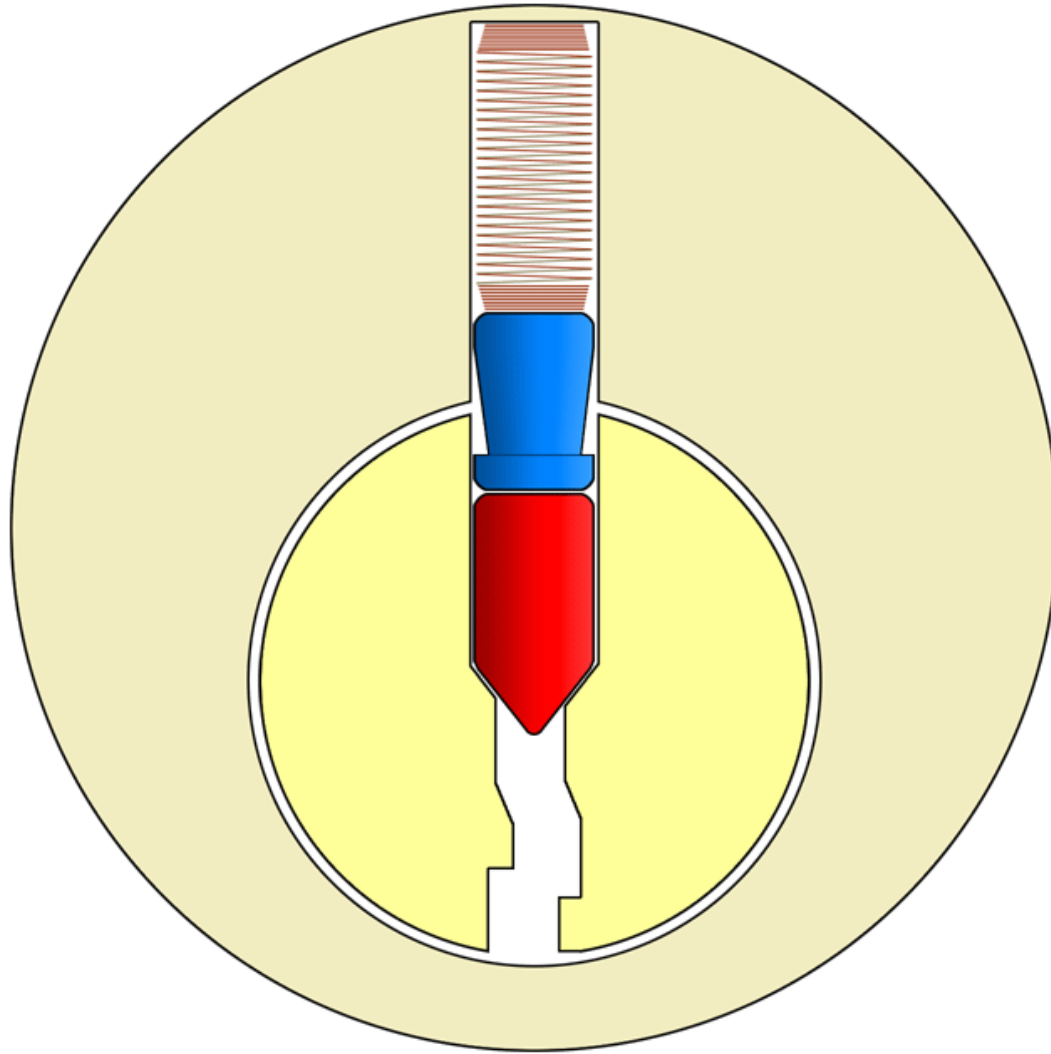

Pick-Resistant Pins - Serrated Pin

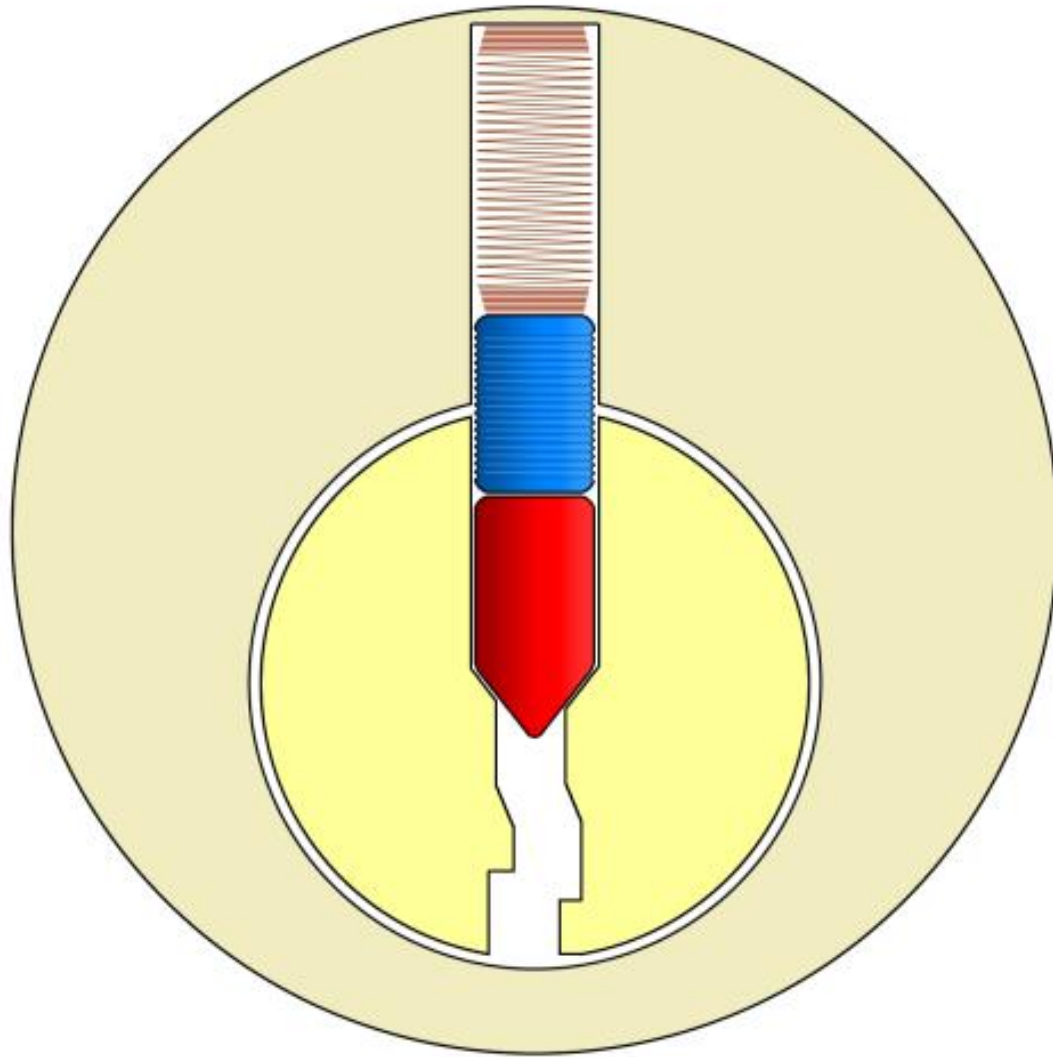

Pick-Resistant Pins - ASSA

"Sneak" pins

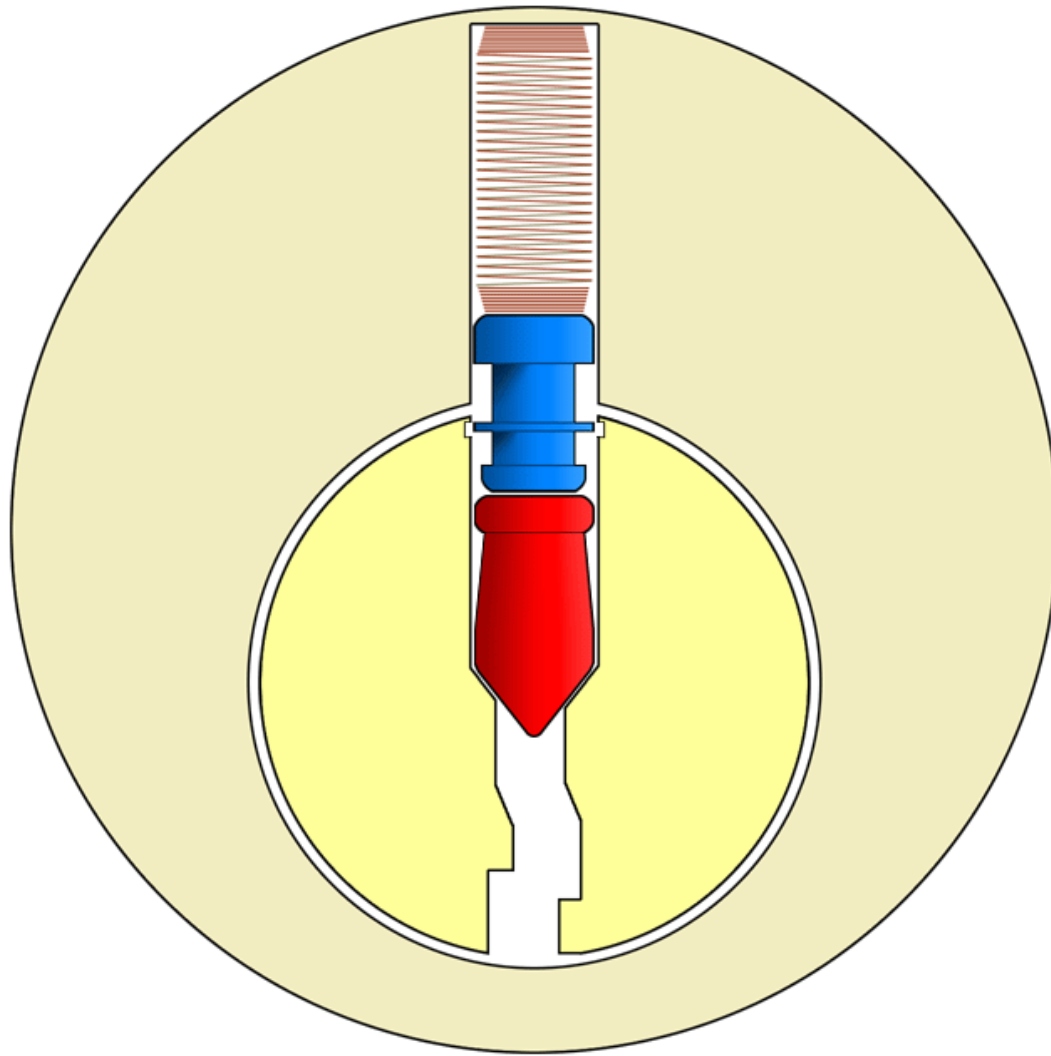

Pick-Resistant Pins - TrioVing

"Double Mushroom" Pin

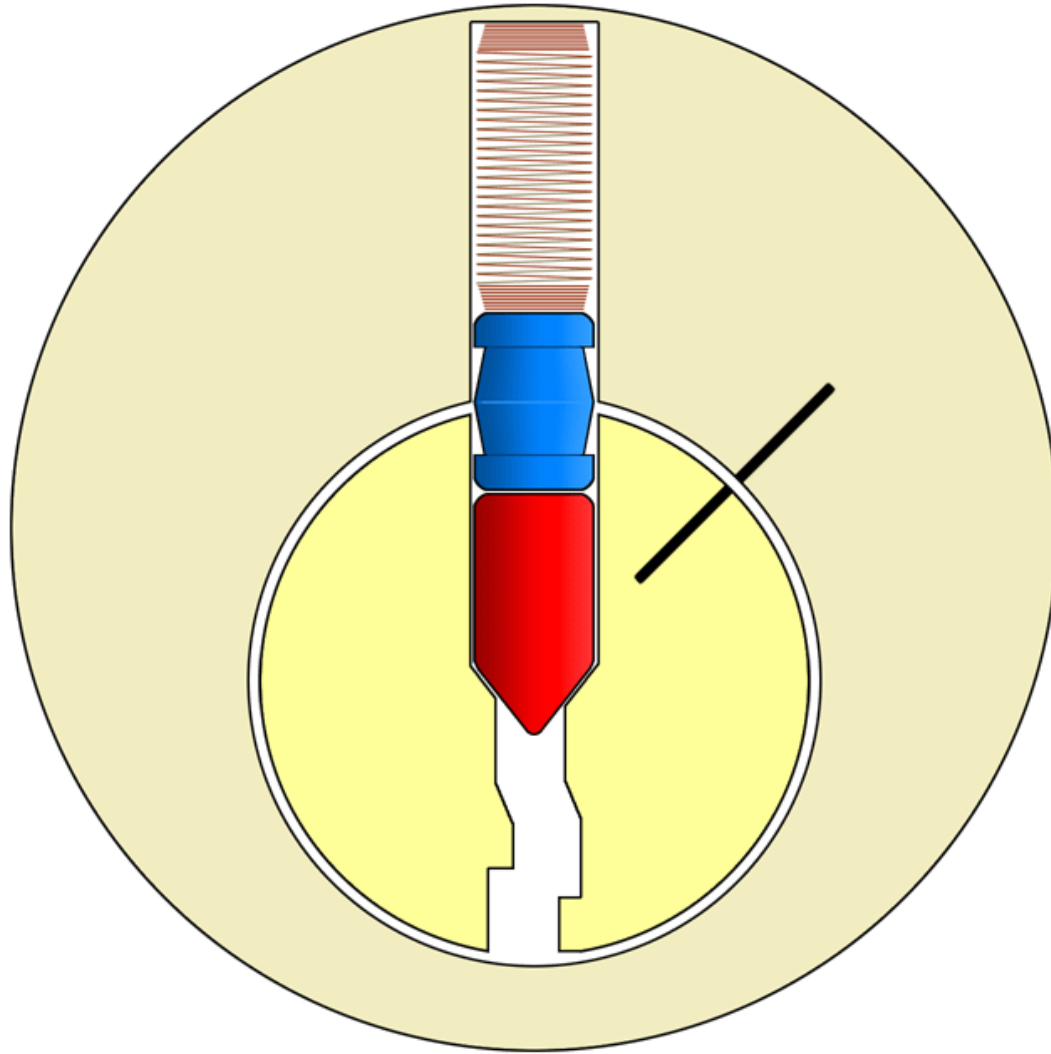

Pick-Resistant Locks

a substantial improvement...



...can be picked, but only with

Questions?

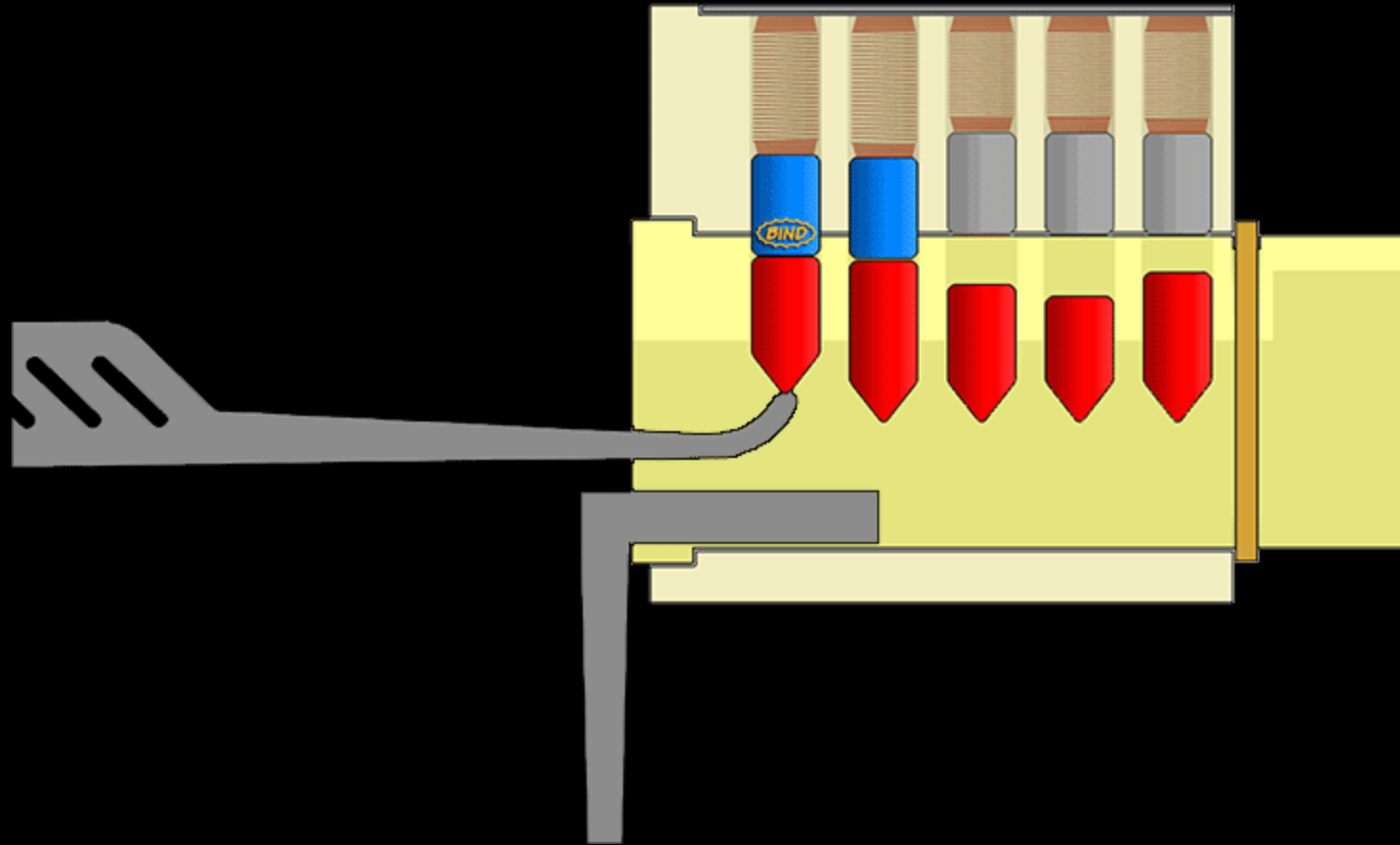

Bumping Attacks

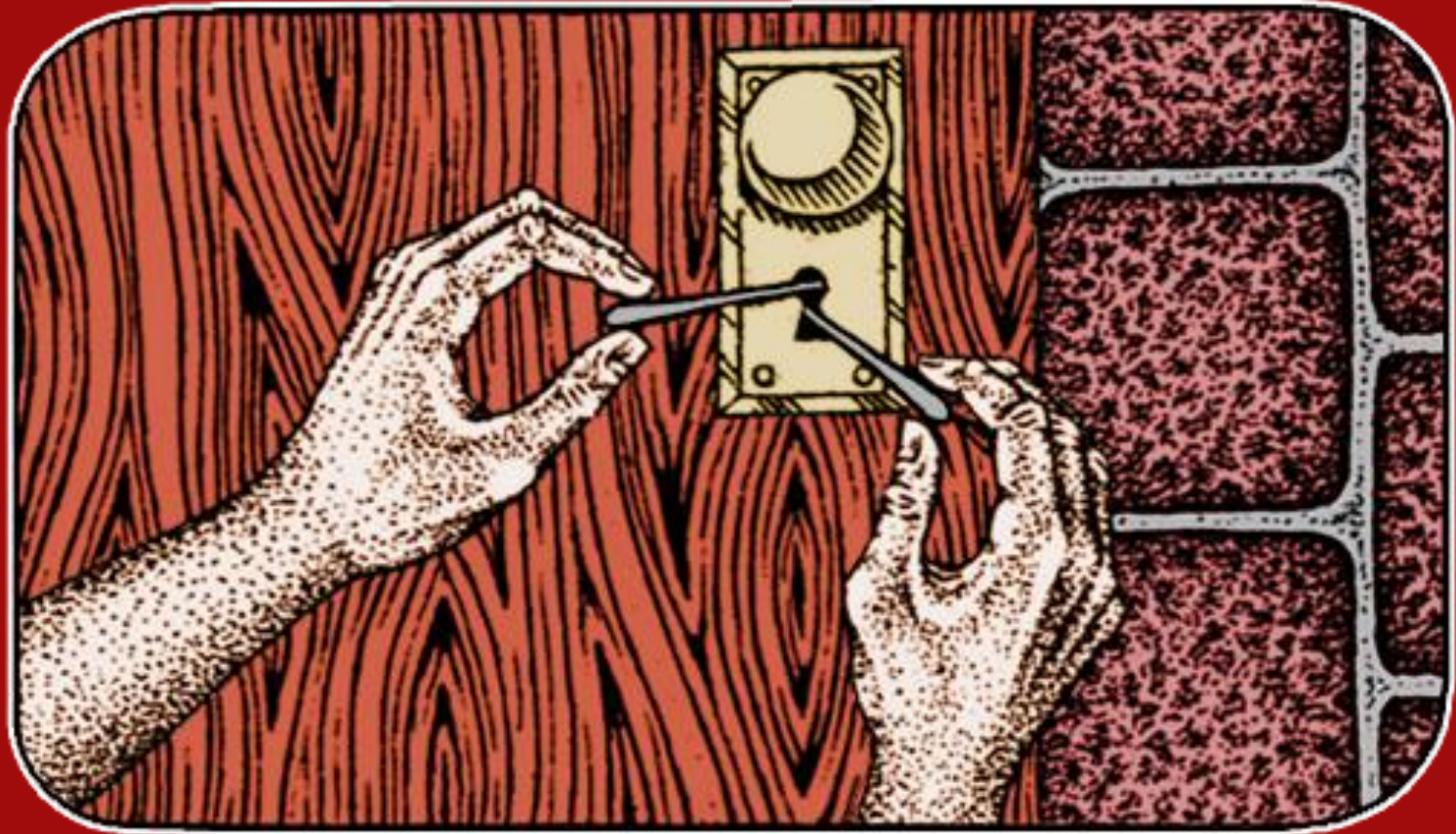

Lock Bumping

- Just a Special Key
- Little Special Skill
- Many Locks are Vulnerable
- Exploit Related to Pick Lock Physics



Lock Bumping

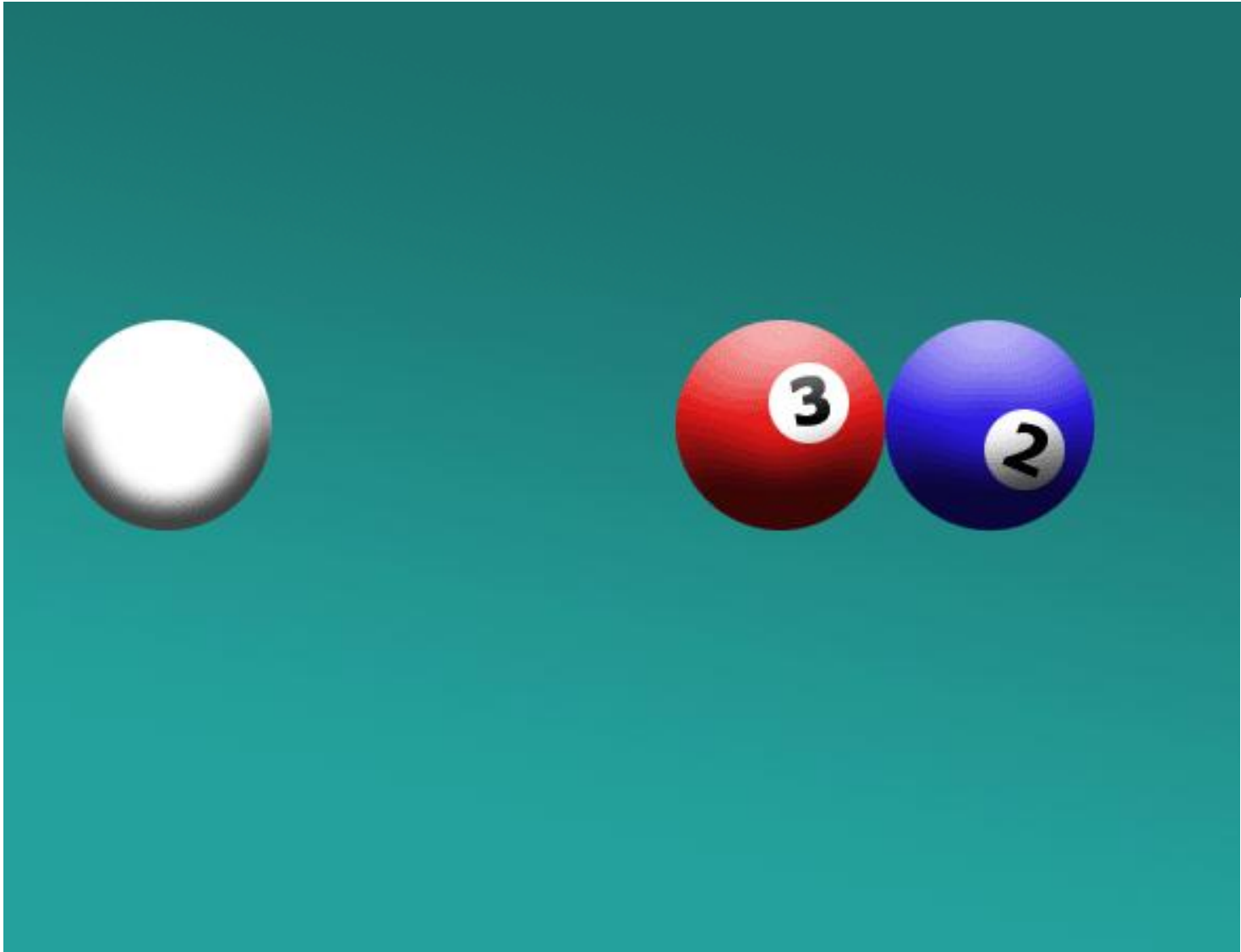

Lock Bumping

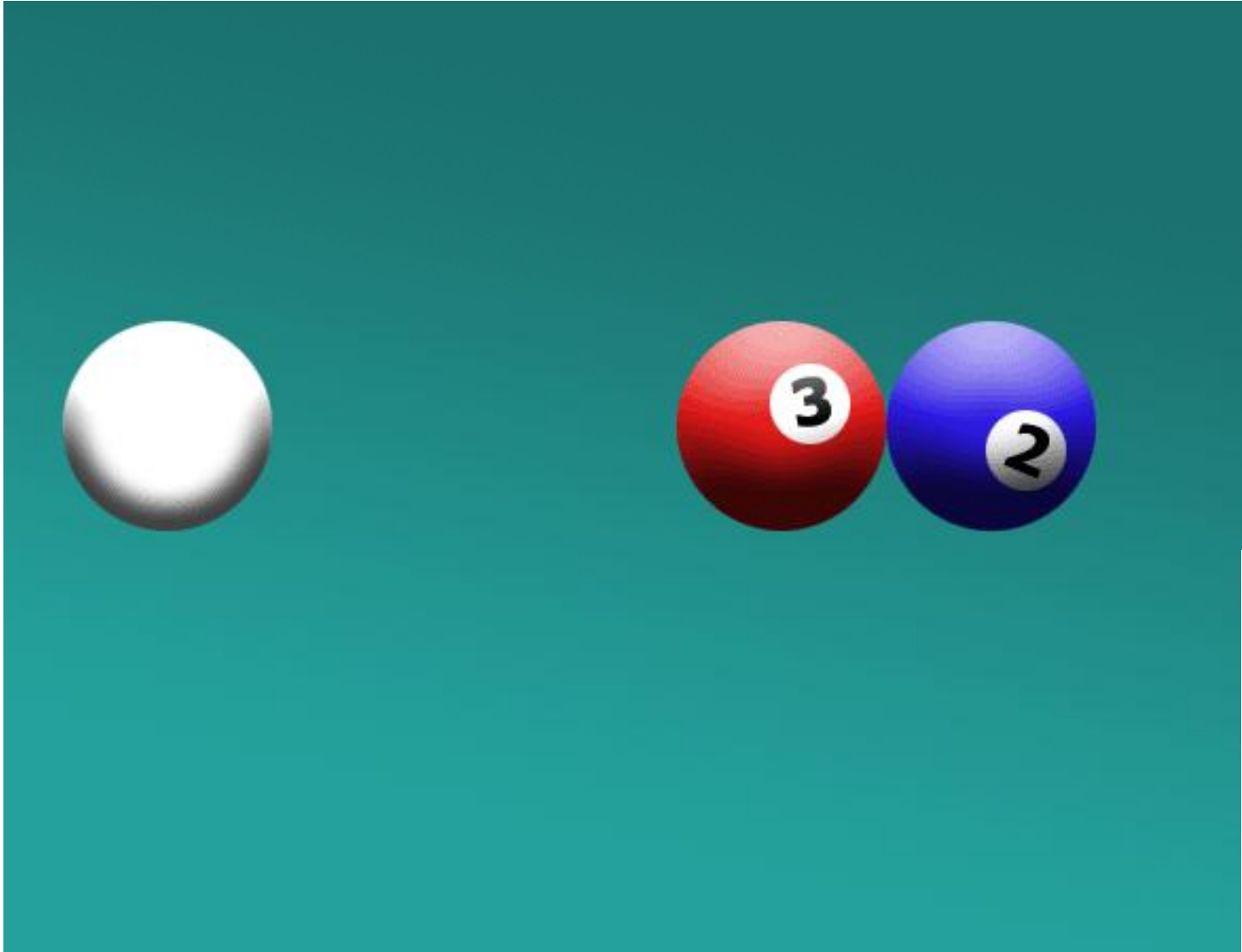

Snapping Guns



Snapping Guns

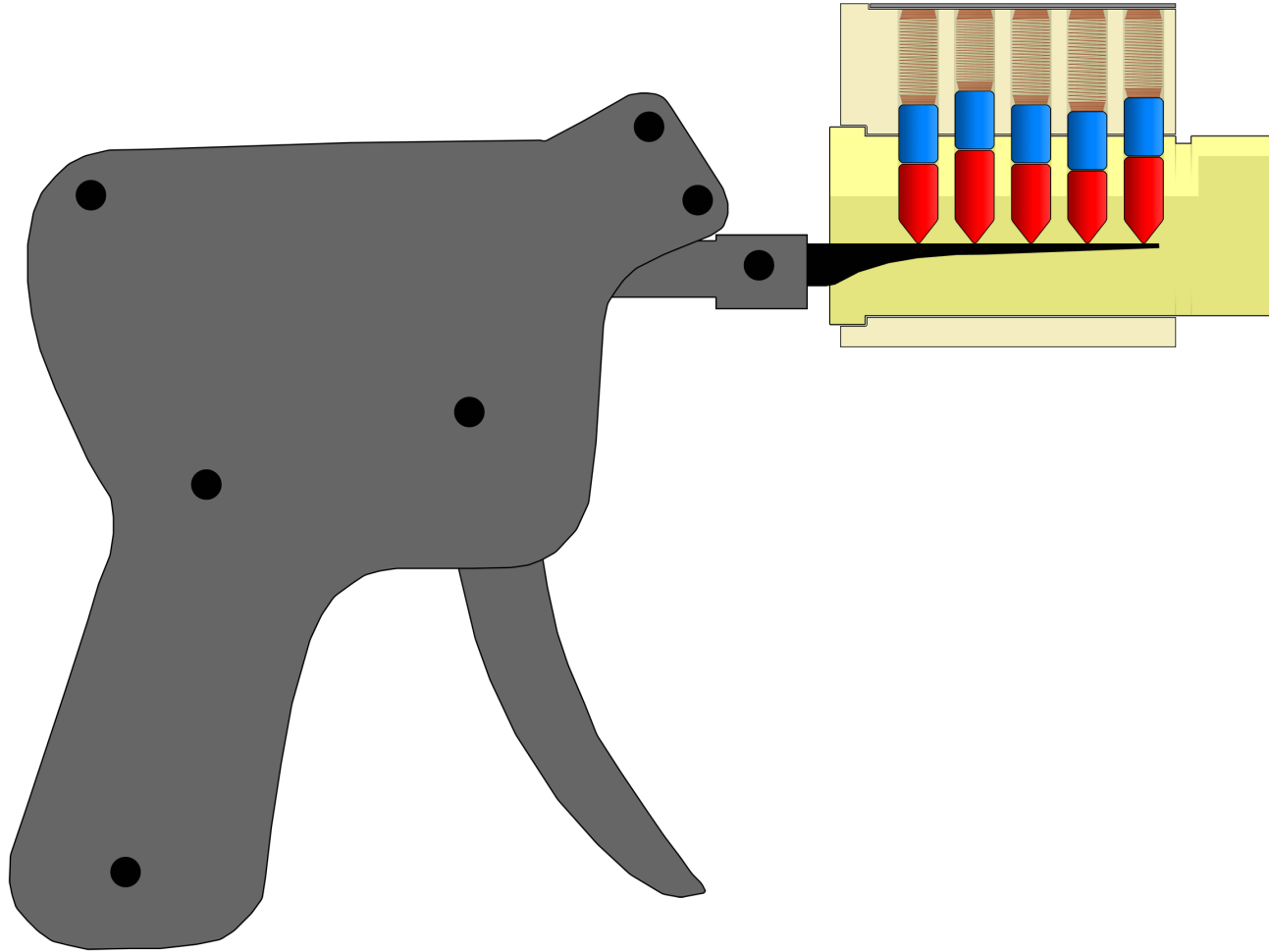

Snapping Guns

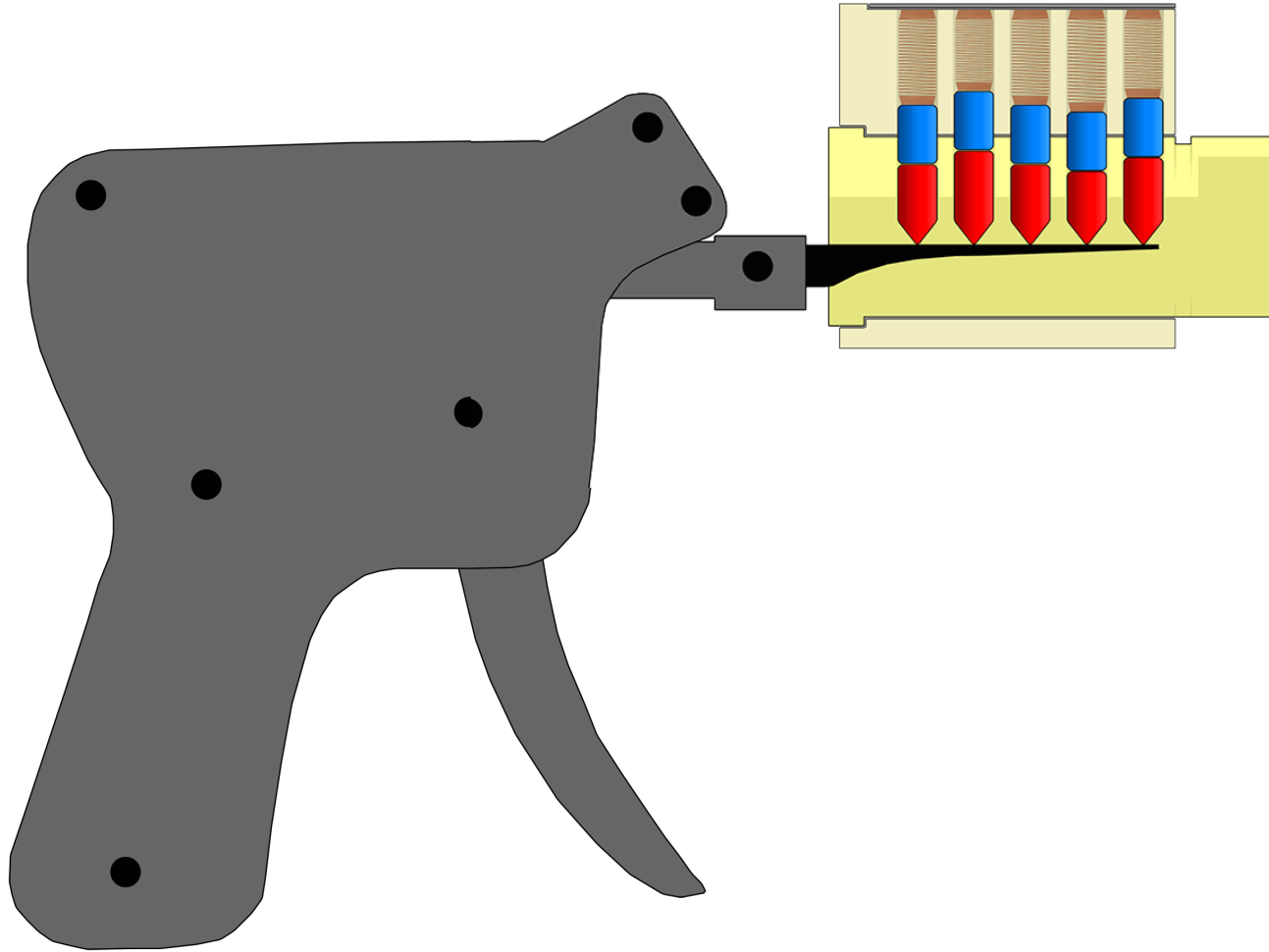

Snapping Guns

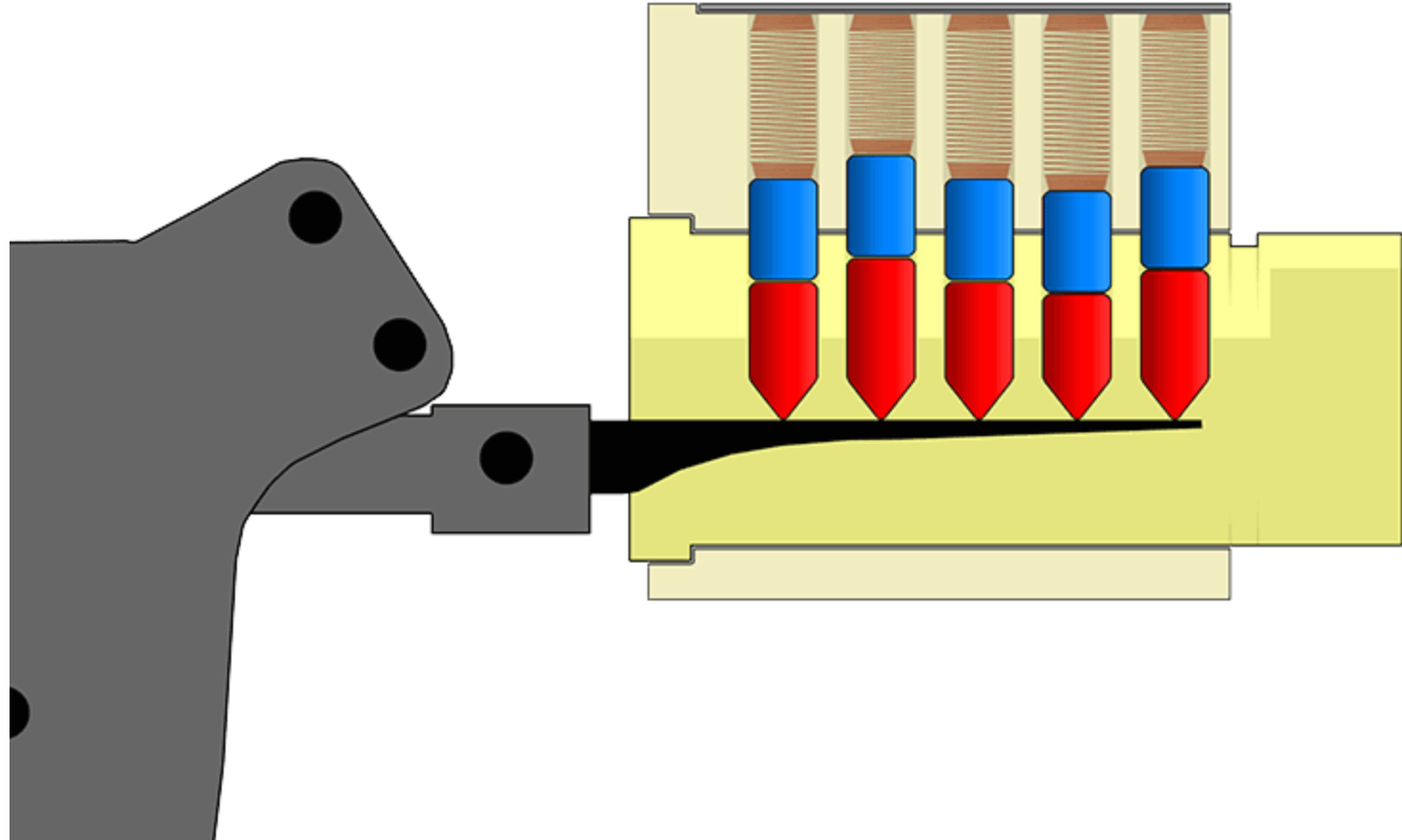

Lock Bumping - Pull Method

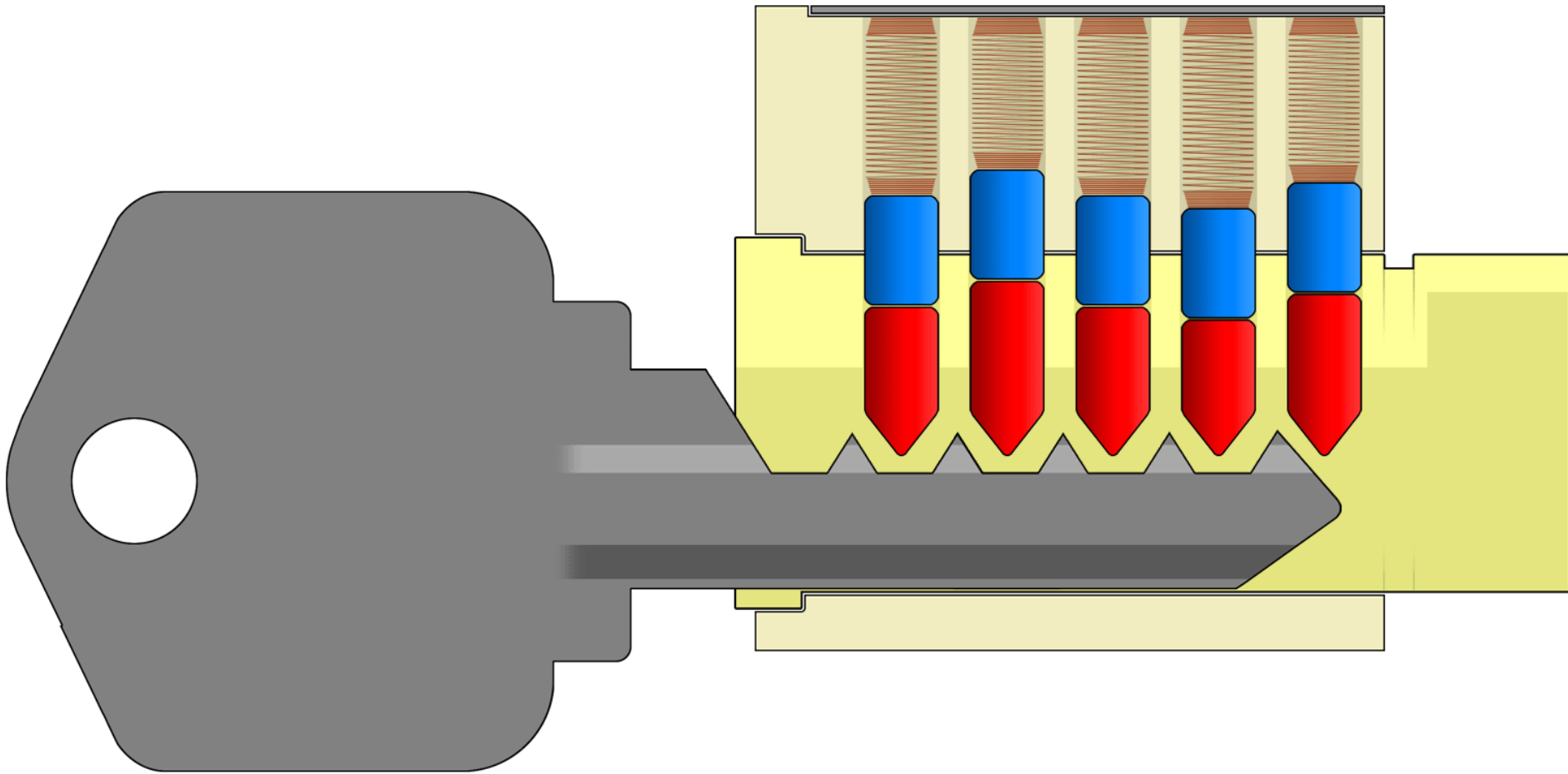

Lock Bumping - Push Method

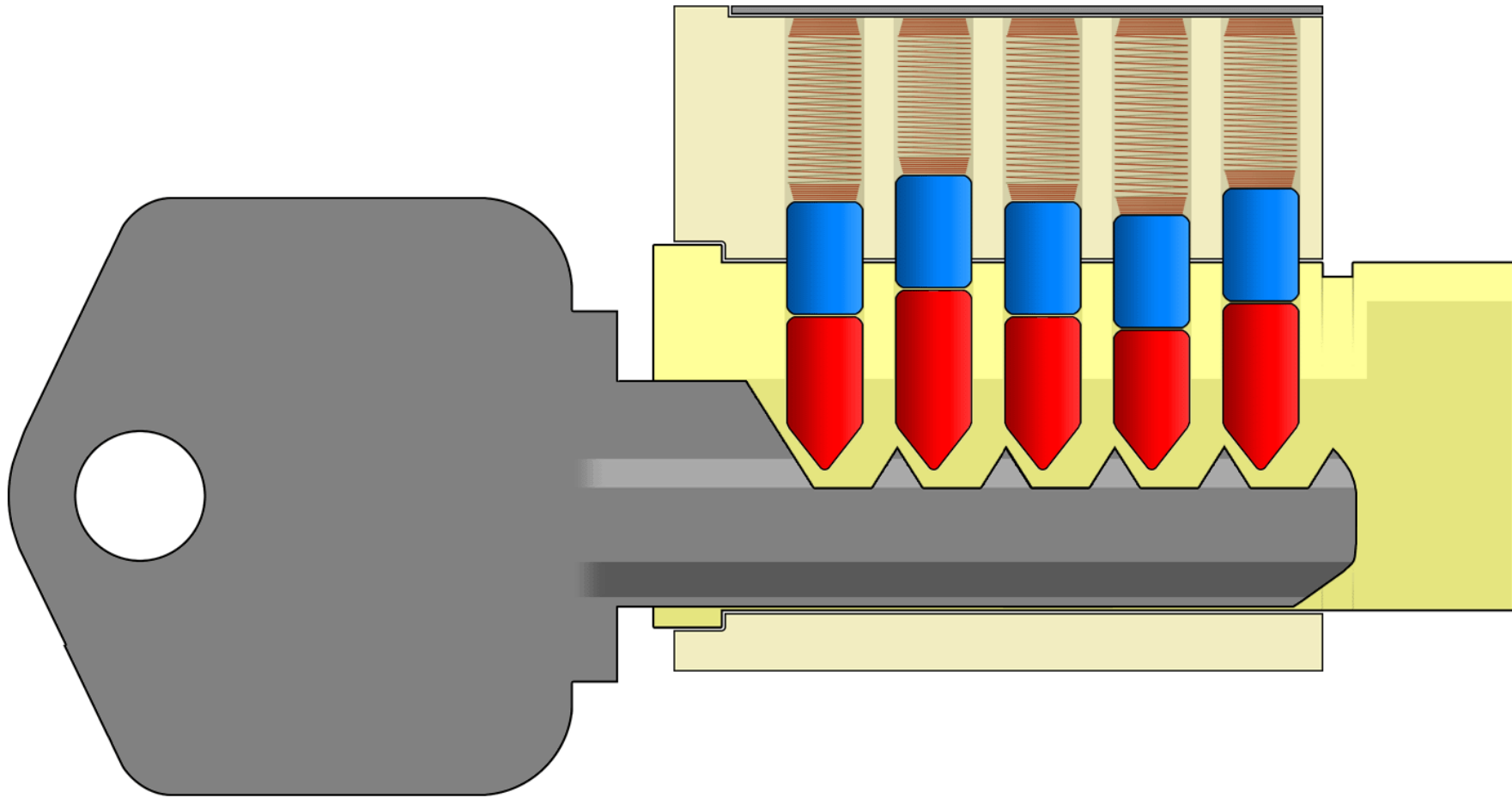

Lock Bumping - Push Method

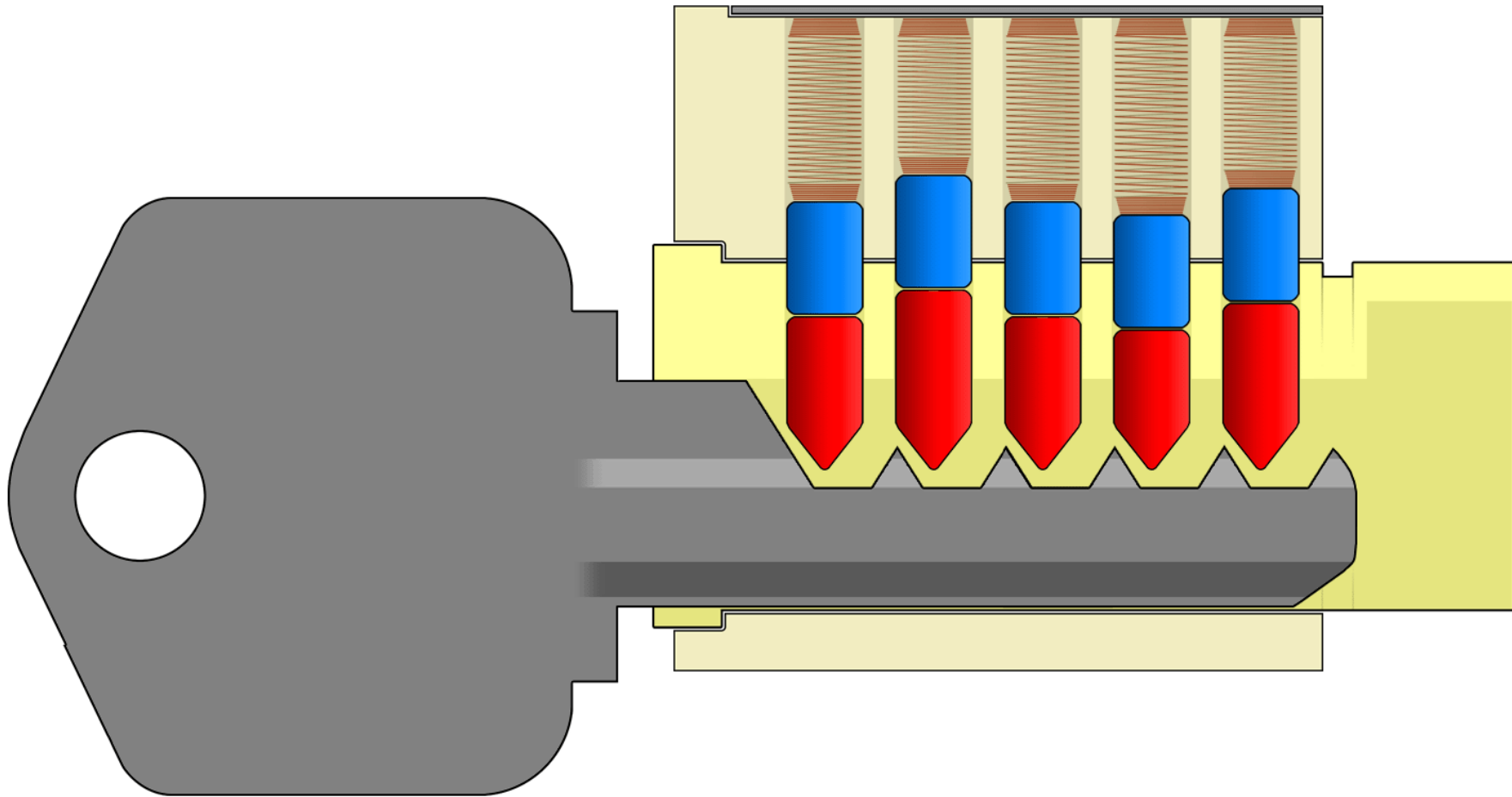

Lock Bumping



<http://tool.nl/bumping.pdf>

Lock Bumping

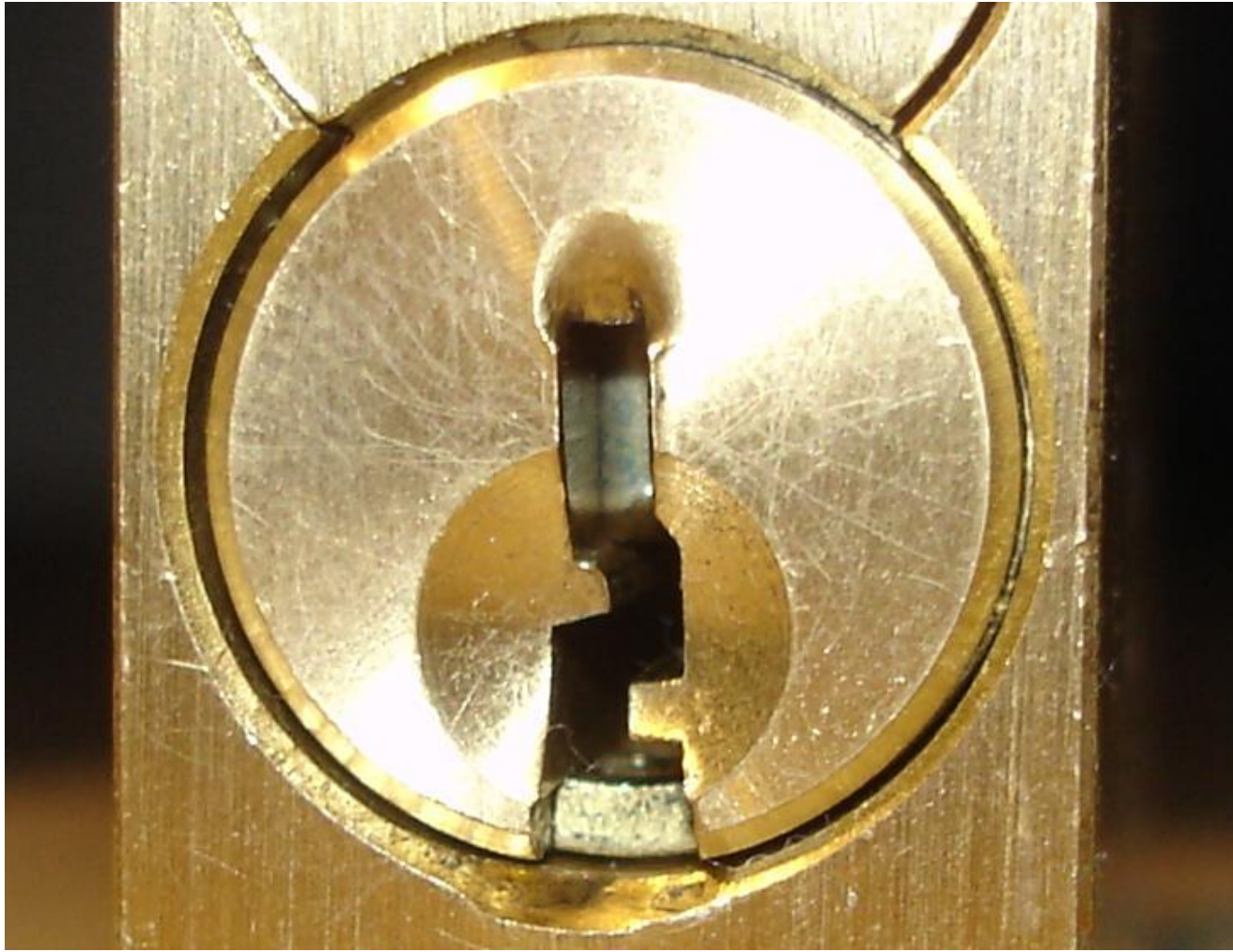
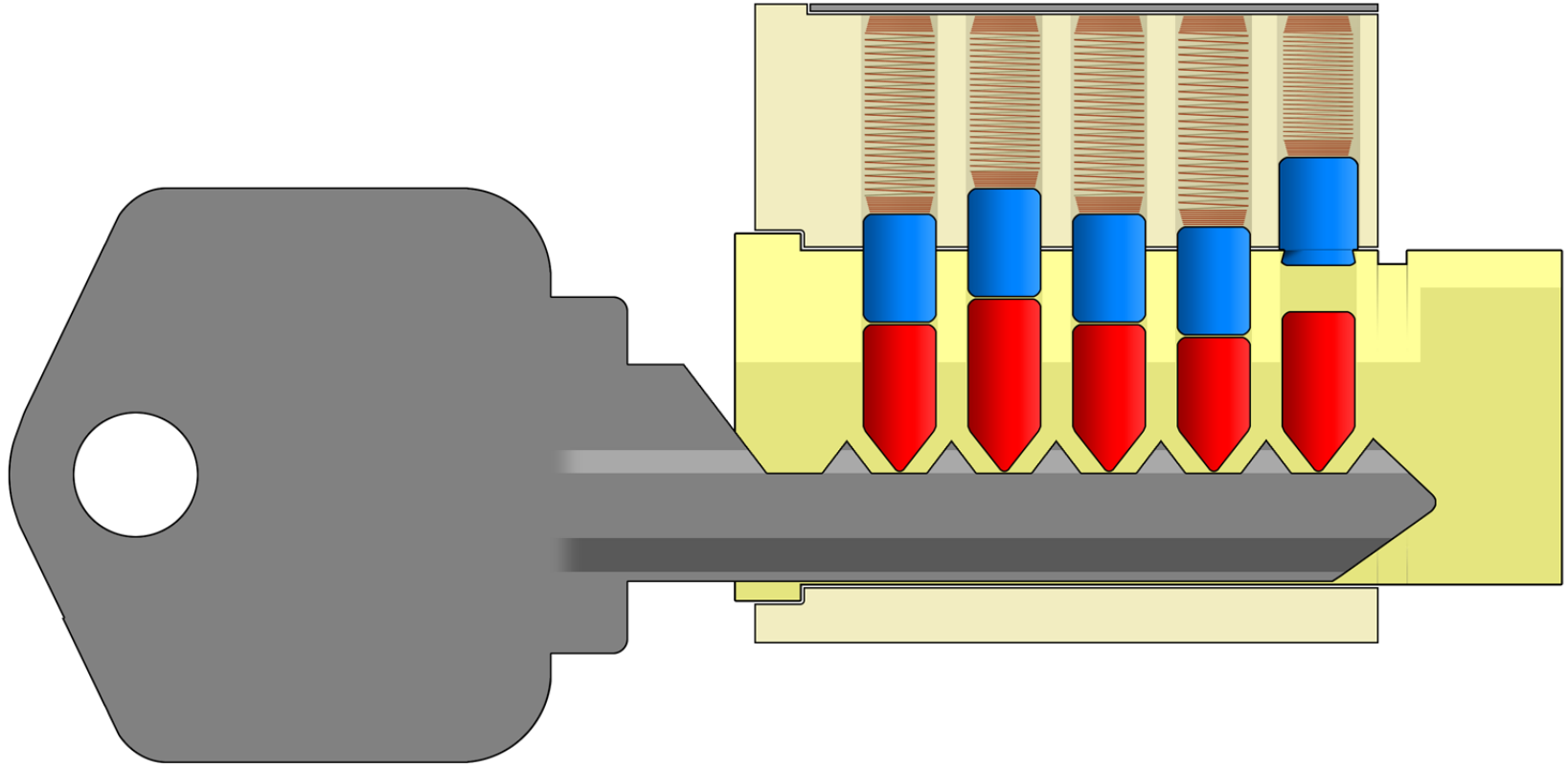

photo courtesy of datagram

Bumping Countermeasures - Top

Gapping



Bumping Countermeasures - Anti-Bump Driver Pin

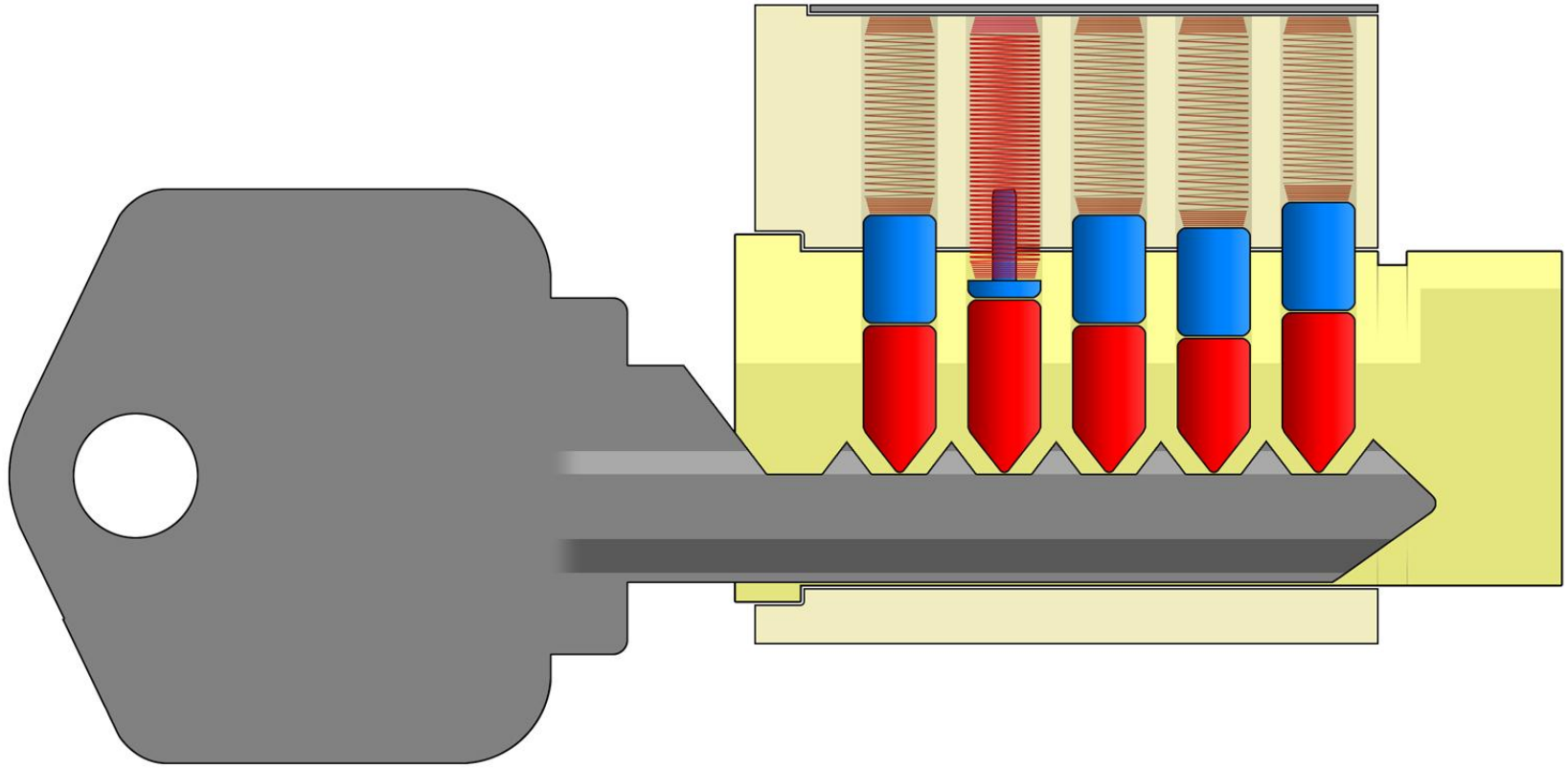

Bumping Countermeasures - Anti-Bump Driver Pin

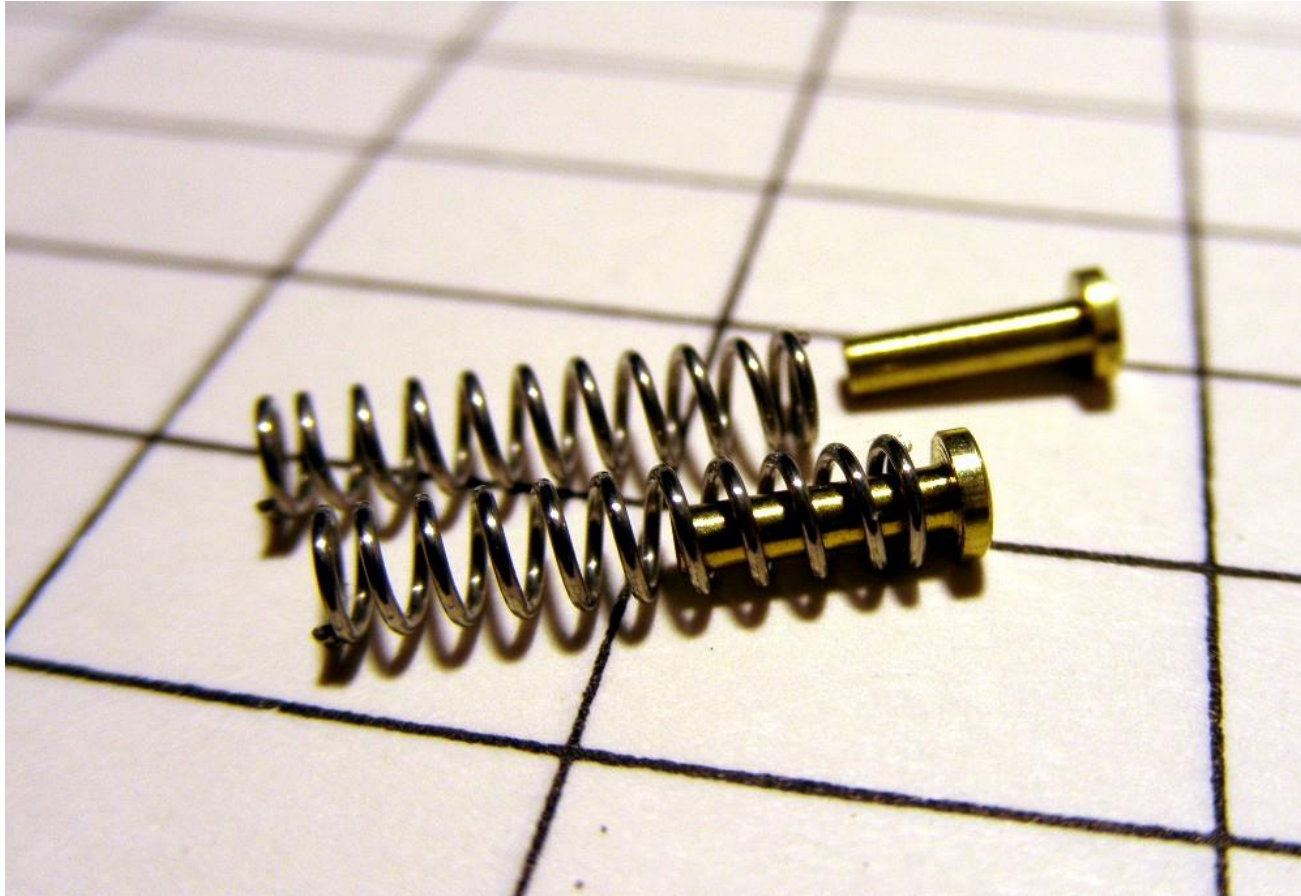

Bumping Countermeasures - Anti-

Bump



Search

About Us

Products

Literature / Support

News / Events

Contact Us

Product Registration

Key Blanks & Key Accessories

Key Machines

Automotive Key Tools & Equipment

Cylinders

↳ Mortise Cylinders

↳ Rim Cylinders

↳ Interchangeable Core Cylinders

↳ Key-in-Knob Cylinders

↳ Profile Cylinders

↳ Mortise Deadbolt

↳ Bump Halt >

↳ Specialized Cylinders

Storefront Hardware & Exit Devices

Door and Security Hardware

Engraving Equipment

Merchandising & POS

Home > Products > Cylinders > Bump Halt

Bump Halt™ (Bump Resistant Cylinders)



Bump Halt provides a "bump resistant" solution for the Ilco line of Key in knob / Key in Deadbolt, Mortise and Rim Cylinders. This Innovative Patent Pending solution to bumping will resist the transfer of force from the bump key to the pins.



Kits are also available that will enable conversion of a new or existing Ilco Cylinder.

- Effective yet cost efficient
- No special tools or machining required
- Available factory installed or as a conversion kit
- Conversion kits contain 10 pins, 10 springs and instructions (one pin and one spring will resist bumping; add an additional pin and spring to increase the security).

Bump Halt™ has not been tested on competitive brands of cylinders.

Documentation

Cylinders brochures, pricing information, manuals, parts lists, etc. can be found on the literature grid section.

[Click here](#) to visit the literature section.

[Read More >](#)

Contact

Kaba Ilco Corp.
400 Jeffreys Road
Rocky Mount, NC 27804
1-800-334-1381

[View Contact Information >](#)

Connect and Share



ILCO® News

Key News - 7 New Key Blanks >

Engrave-It™XP >

Tri-Code HS Optional Kit for Edge Cut Vehicle Keys >

TKO Software - Available Updates >

Bumping Countermeasures - Anti-

Bump



- About Us
- Products
- Literature / Support
- News / Events
- Contact Us

Part Number
7000BH 00 10

List Price
\$17.82

Bump Halt provides a "bump resistant" solution for the Ilco line of Key in knob / Key in Deadbolt, Mortise and Rim Cylinders. This Innovative Fluted Perforating solution to bumping will resist the ramming force from the bumping key to the pins.

Documentation
Cylinders brochures, pricing information, manuals, parts lists, etc. can be found on the literature grid section.
[Click here](#) to visit the literature section.
[Read More >](#)

Contact
Kaba Ilco Corp.
400 Jeffreys Road
Rocky Mount, NC 27804
1-800-334-1381
[View Contact Information >](#)

Connect and Share
[Email](#) [Facebook](#) [LinkedIn](#)

ILCO® News
Key News - 7 New Key Blanks [>](#)
Engrave-It™XP [>](#)
Tri-Code HS Optional Kit for Edge Cut Vehicle Keys [>](#)
TKO Software - Available Updates [>](#)

Kits are also available that will enable conversion of a new or existing Ilco Cylinder.

- Effective yet cost efficient
- Requires special tools, each required
- Available for factory installation or conversion kit
- Conversion kits contain 10 pins, 10 springs and instructions (one pin and one spring will resist bumping; add an additional pin and spring to increase the security.

Bump Halt™ has been tested on competitive brands of cylinders.



http://to

Bumping Countermeasures - Anti-Bump Driver Pin



Locksmiths



Locksmiths



Locksmiths



Locksmiths



Locksmiths

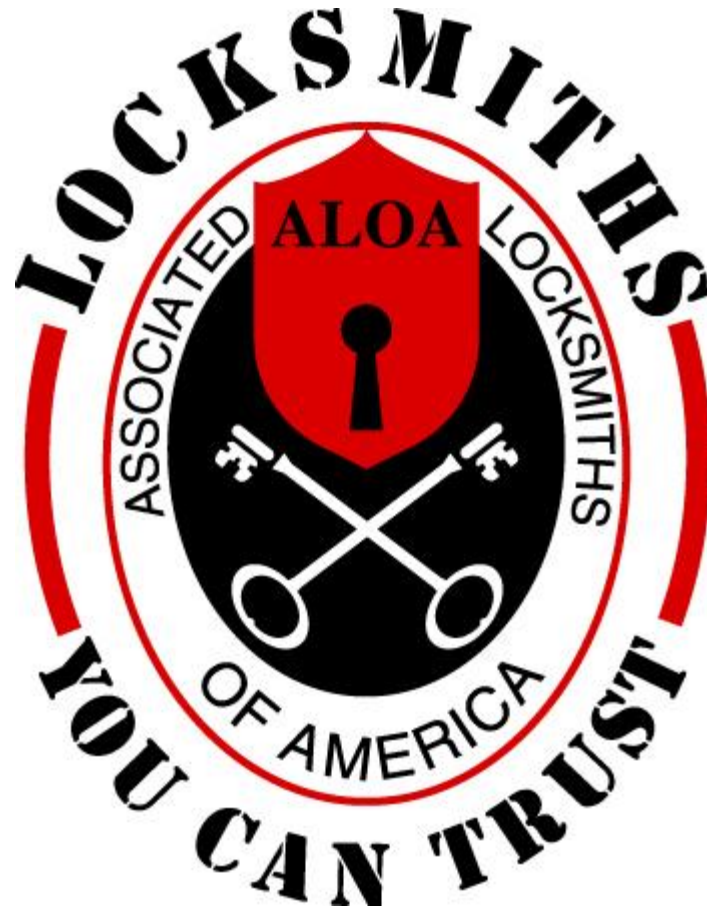

Locksmiths

1. ALOA logo / ALOA number
2. Name
3. Discrepancies
3. Estimates & Itemized Invoice

Locksmiths



Questions?

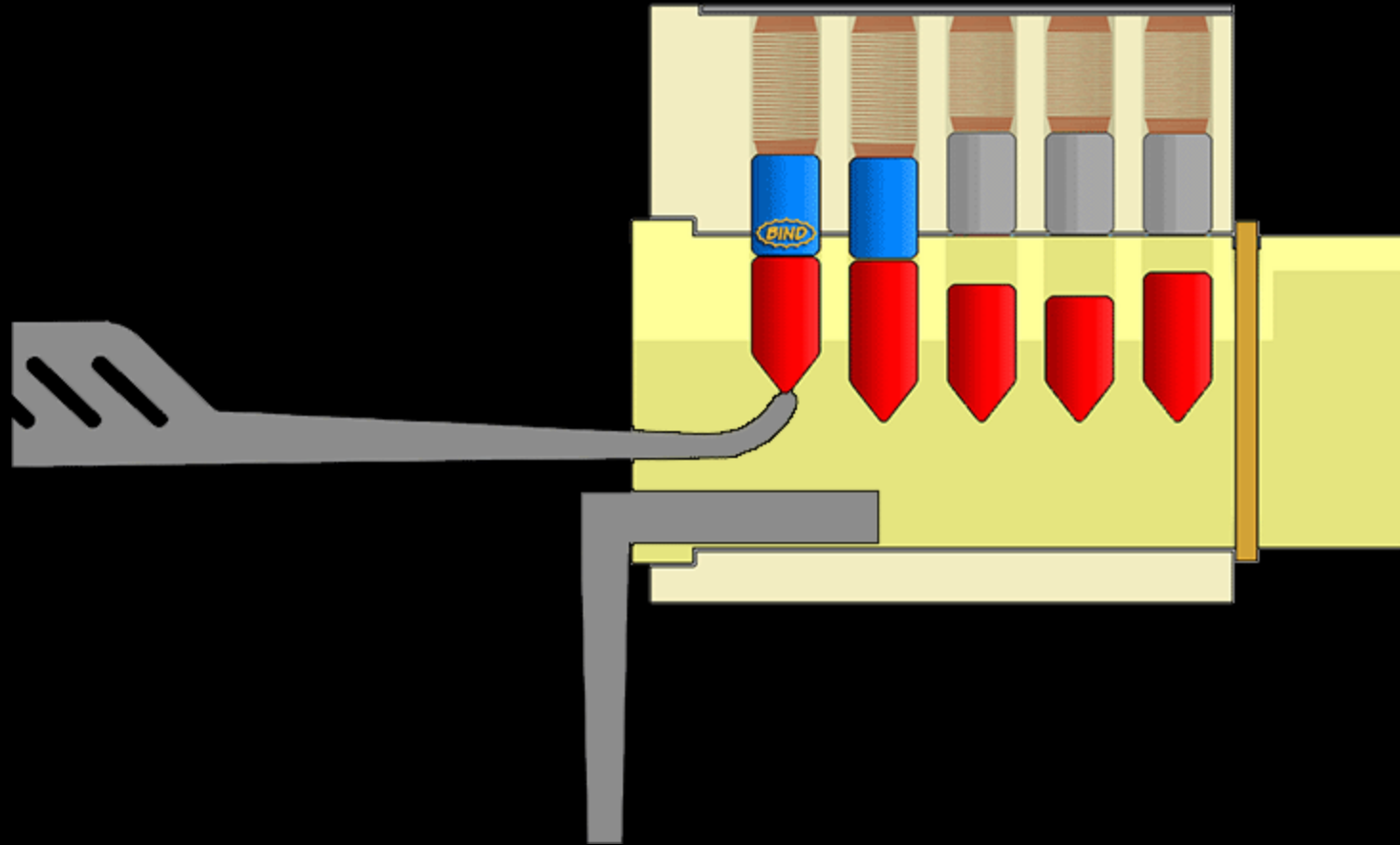

Impressioning

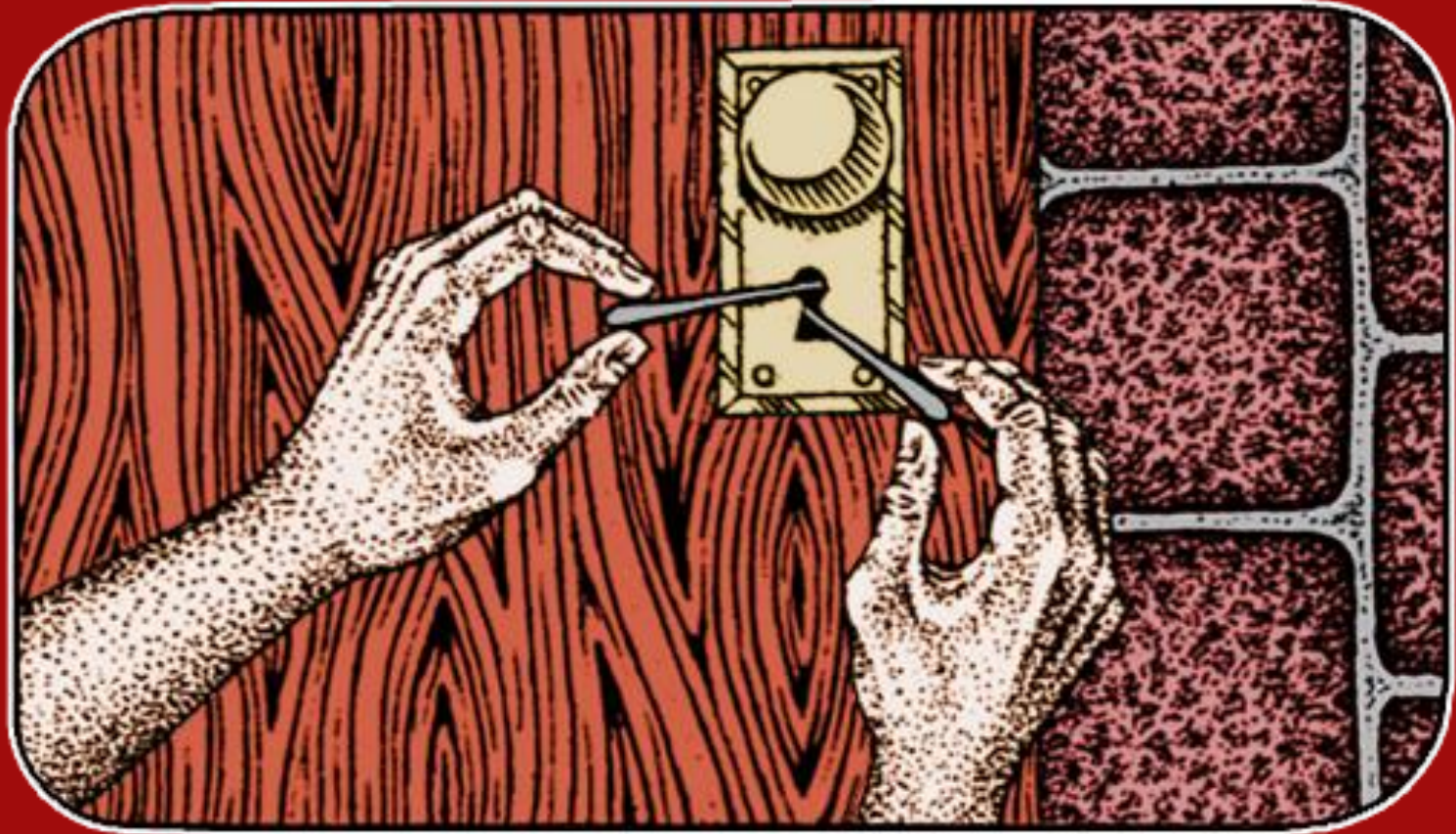

Why Impressioning?



Why Impressioning?



Impressioning - Blank Key to Raise all Stacks

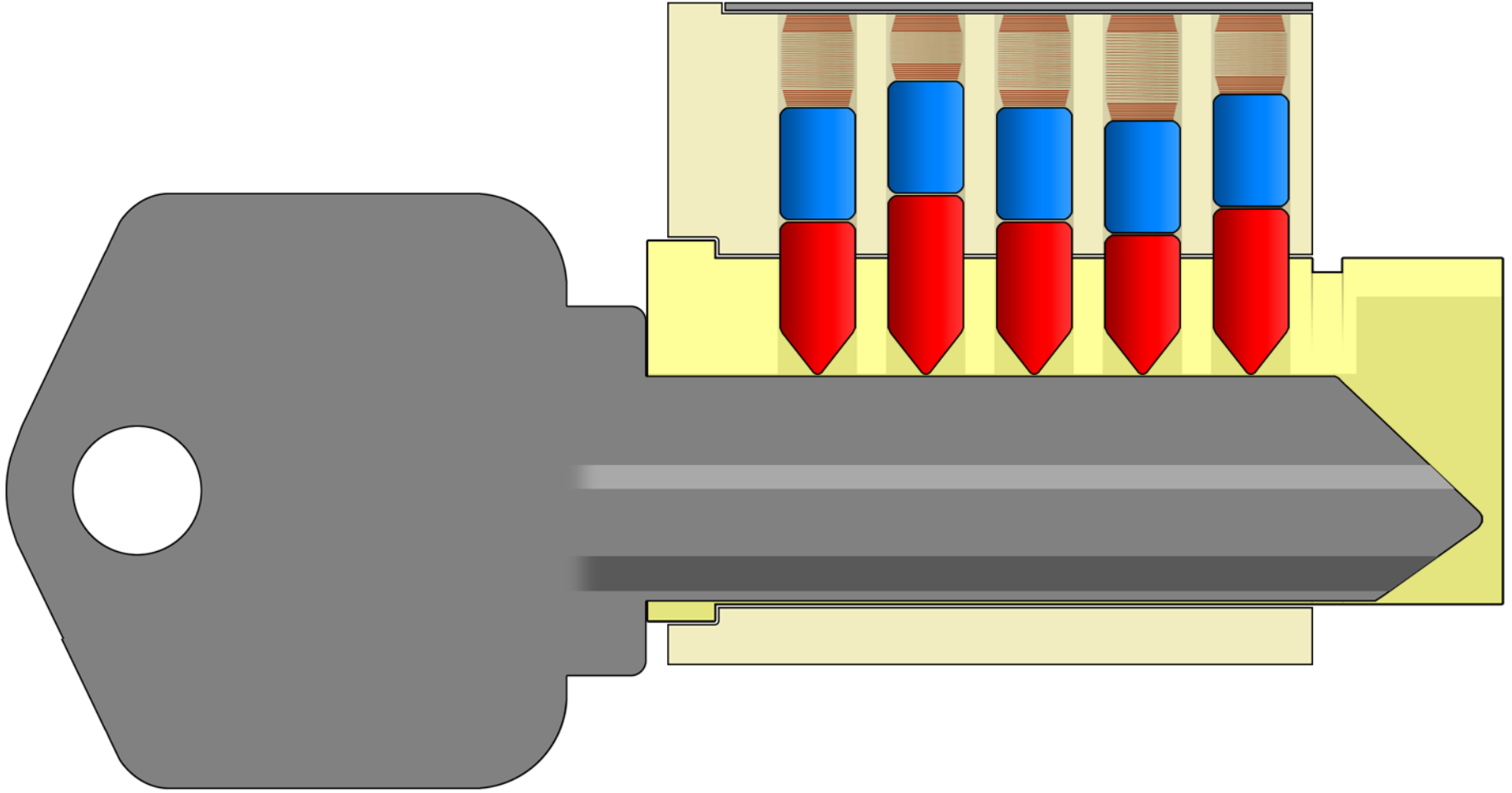

Impressioning - Turn Hard to Bind a Key Pin

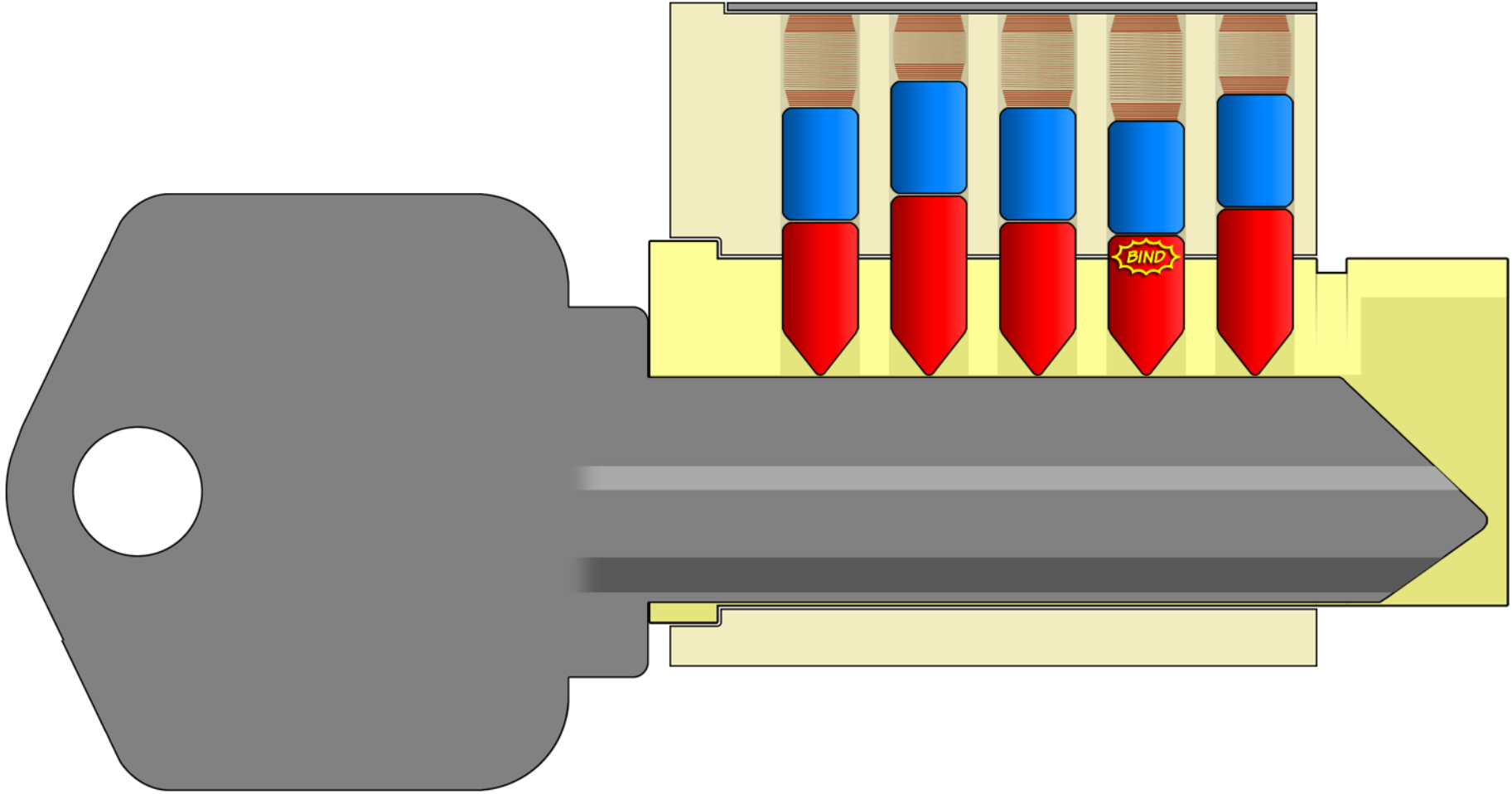

Impressioning - Binding and Wiggling Causes Rubbing

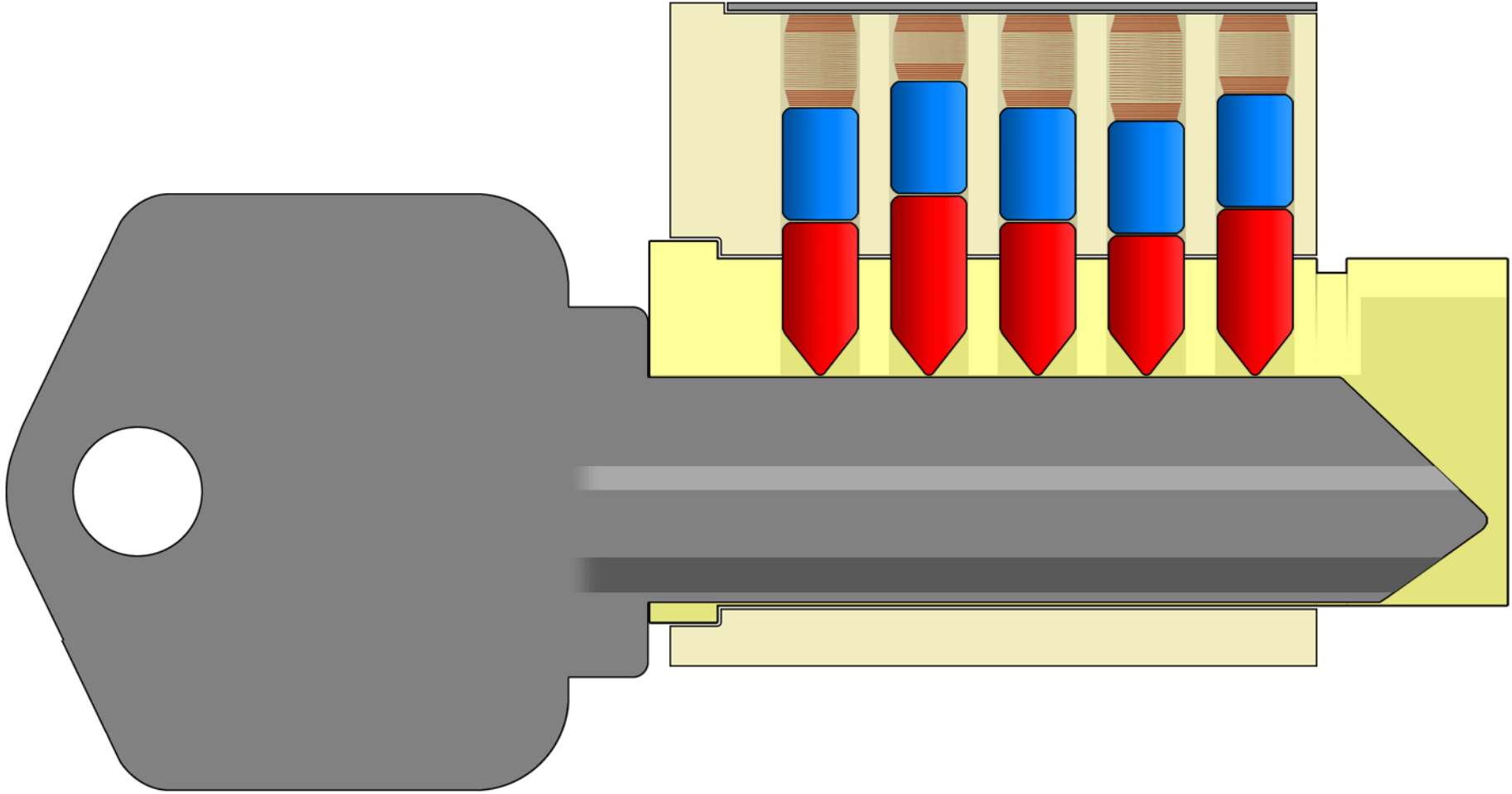

Impressioning - Observe the Rub Marks

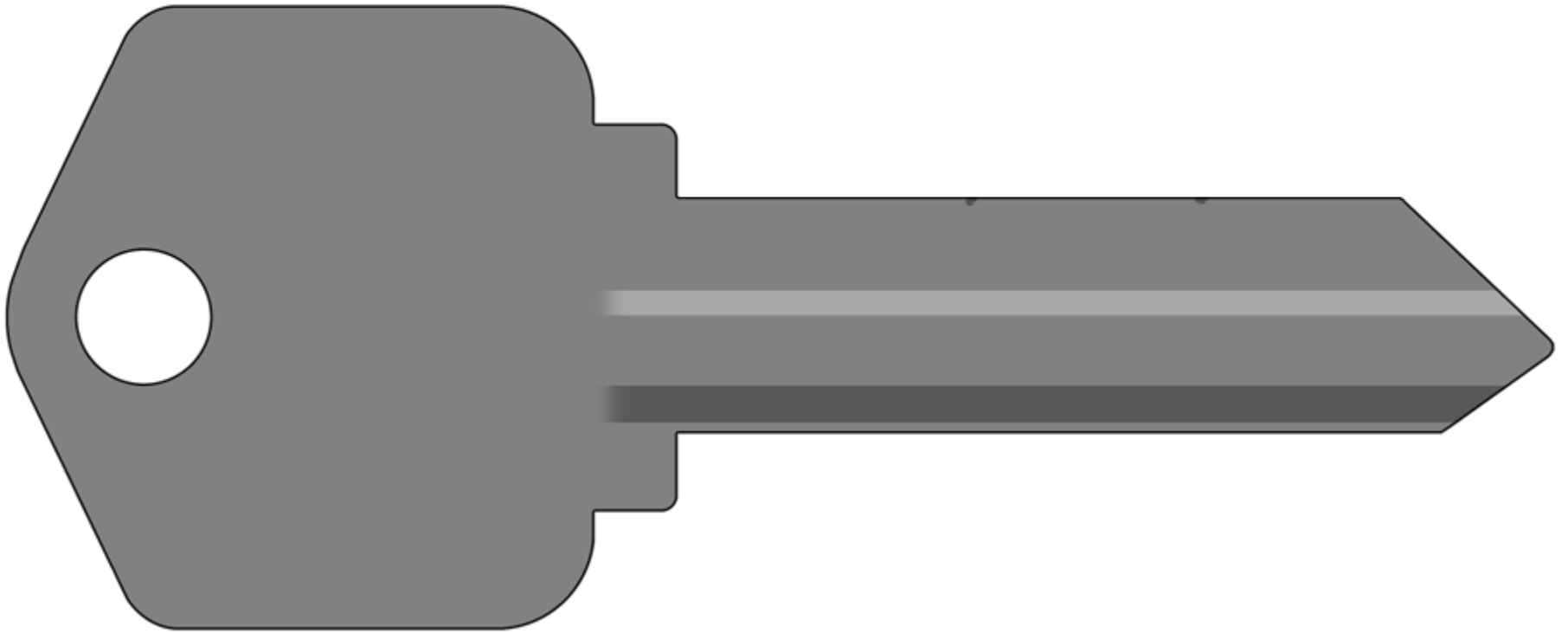

Impressioning - Observe the Rub Marks

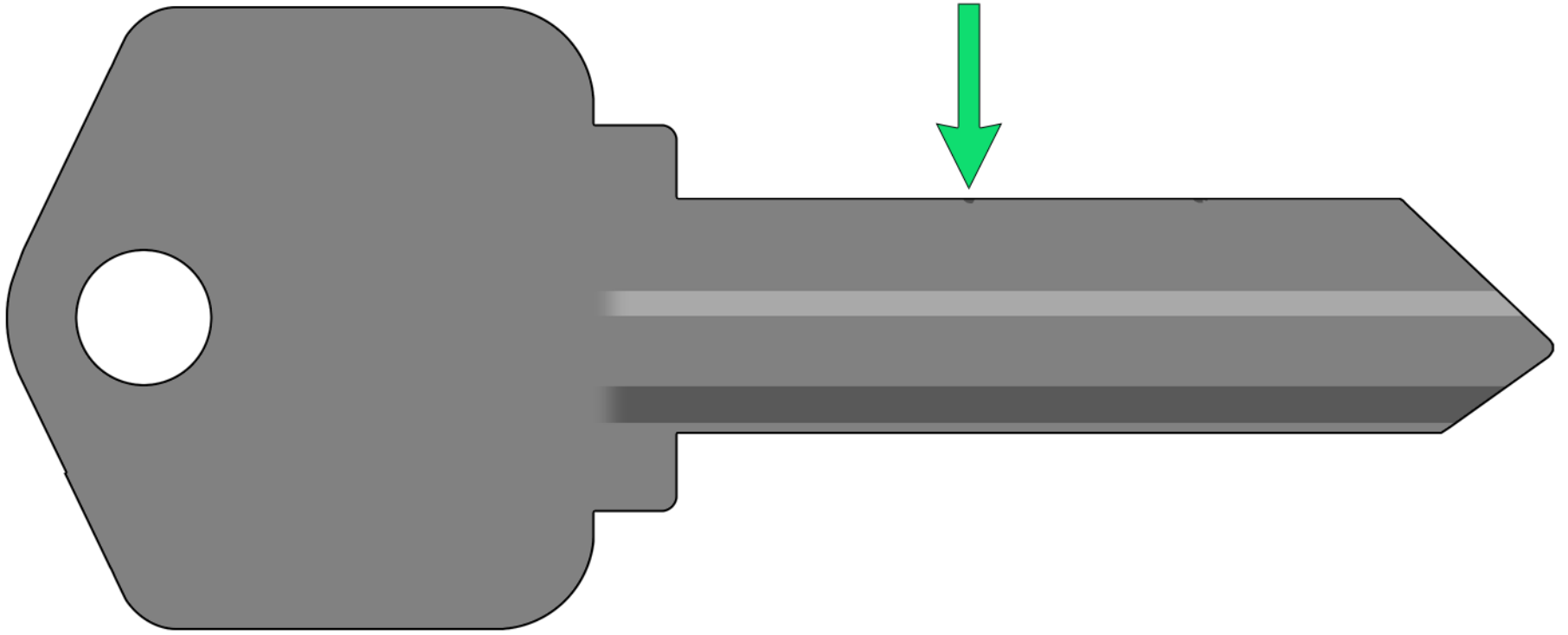

Impressioning - Observe the Rub Marks

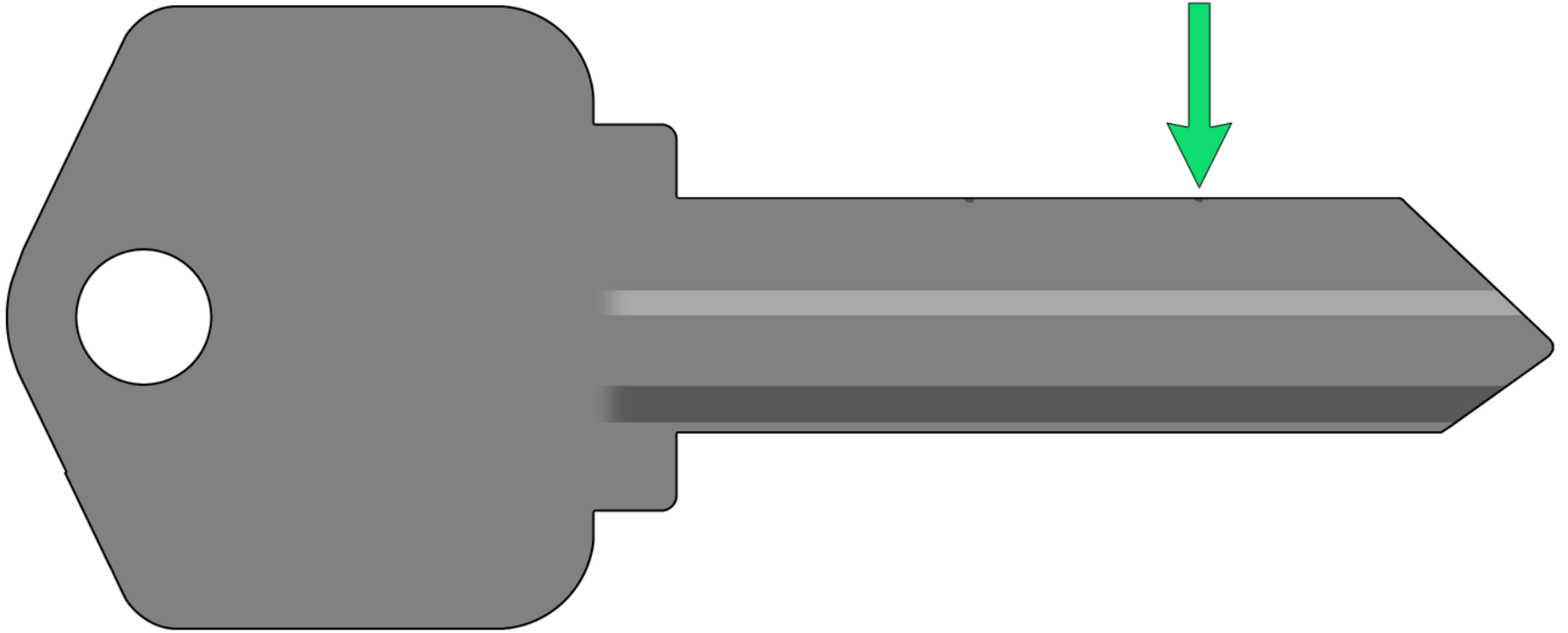

Impressioning - File Down at the Rub Marks

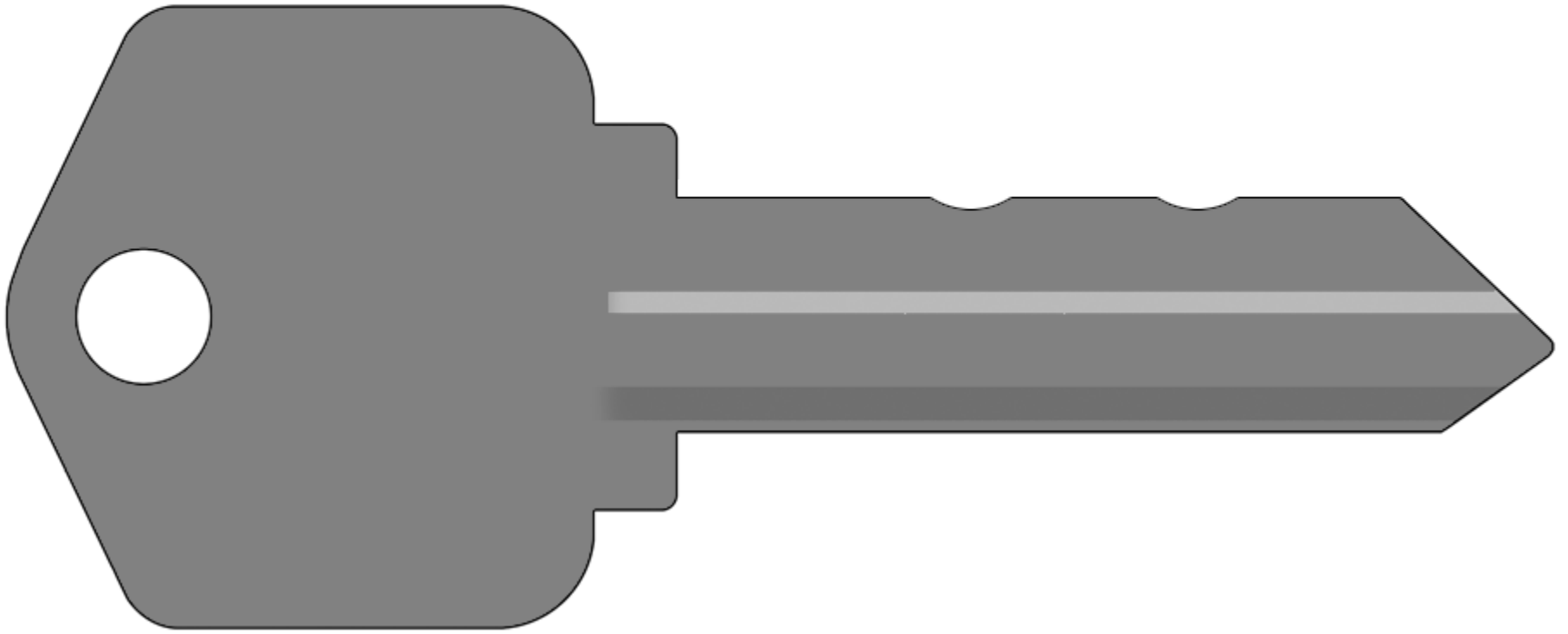

Impressioning - Repeat the Process

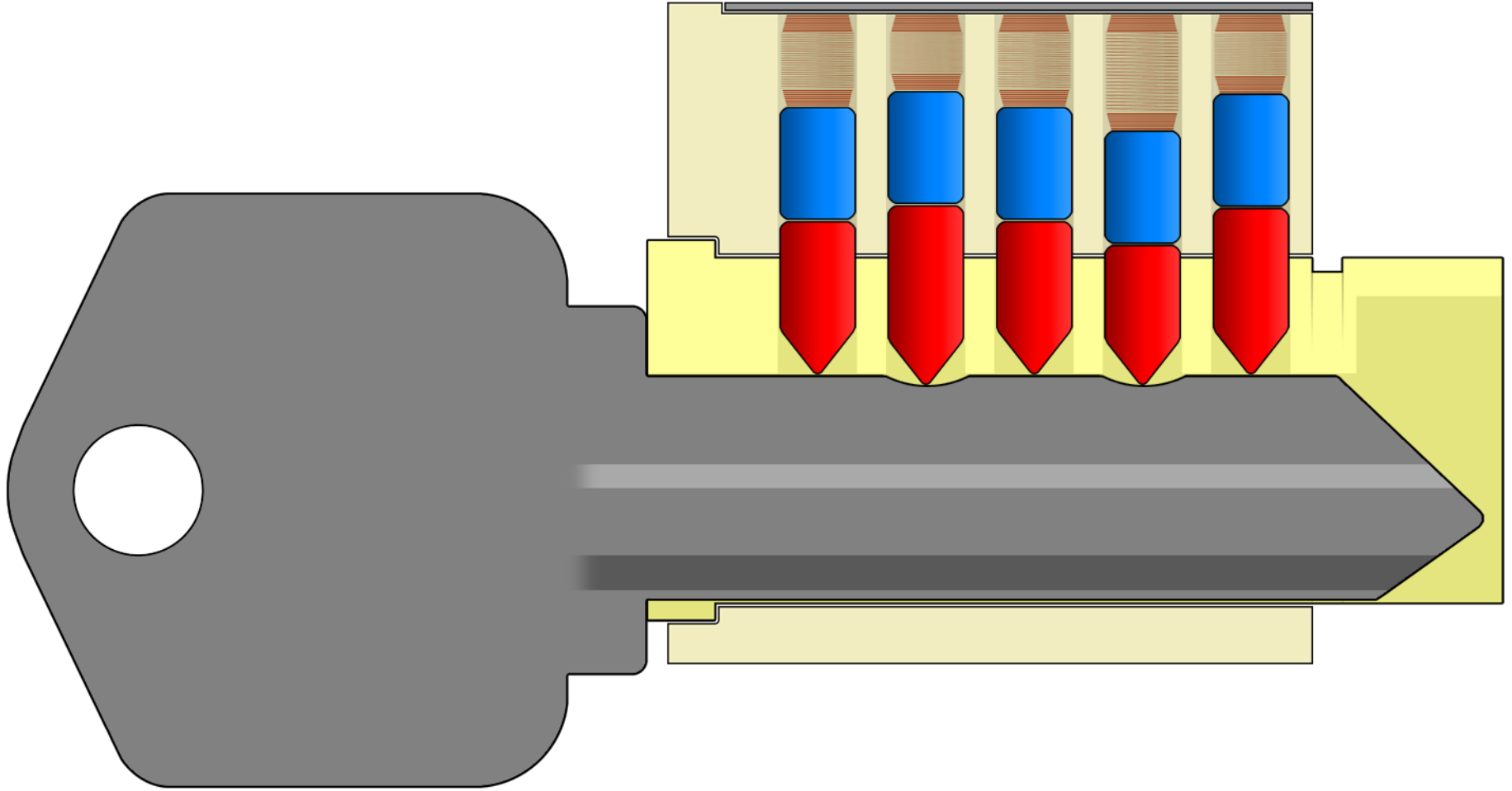

Impressioning - Stack 4 is still Binding

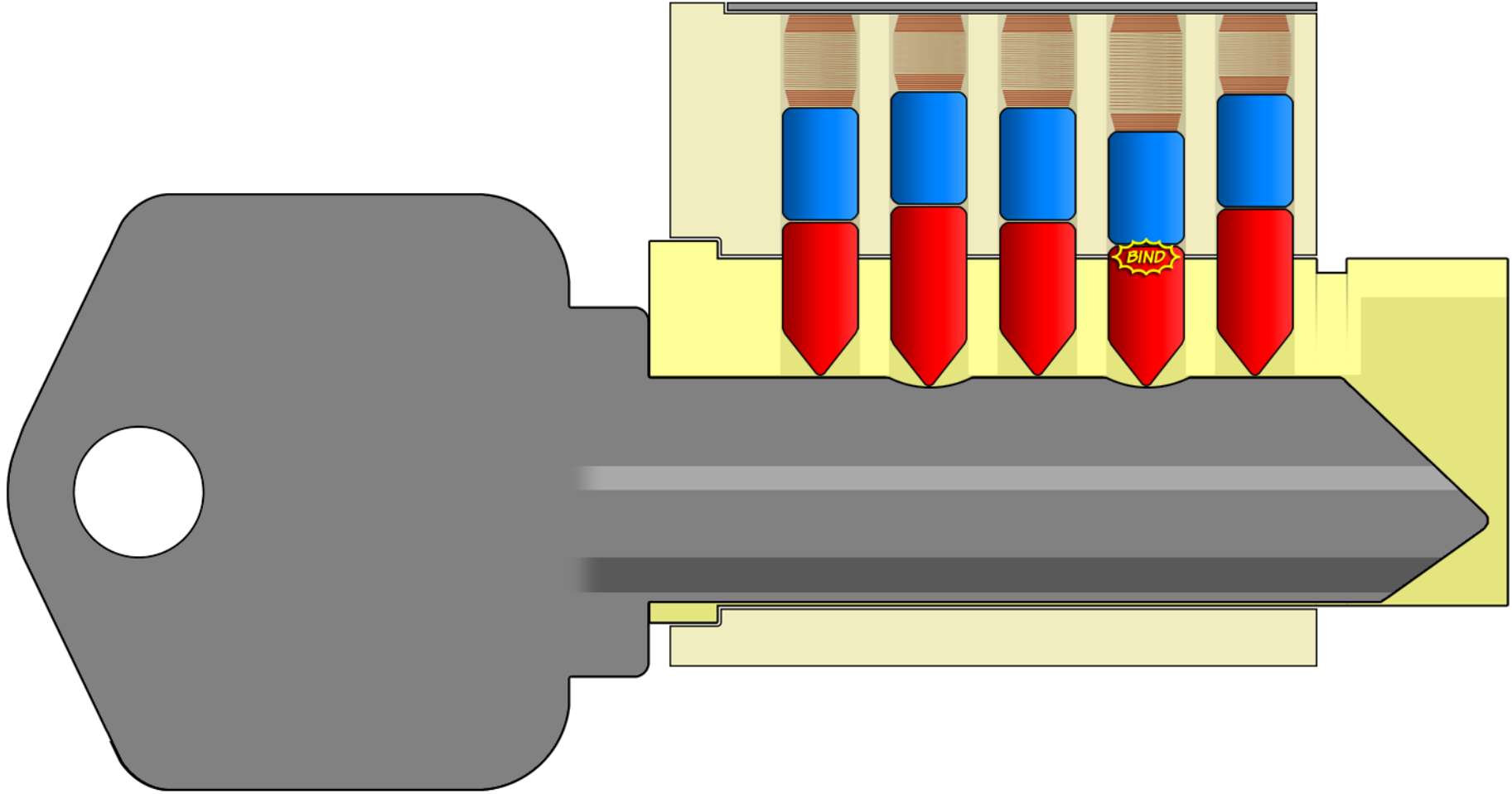

Impressioning - Stack 4 is still Rubbing

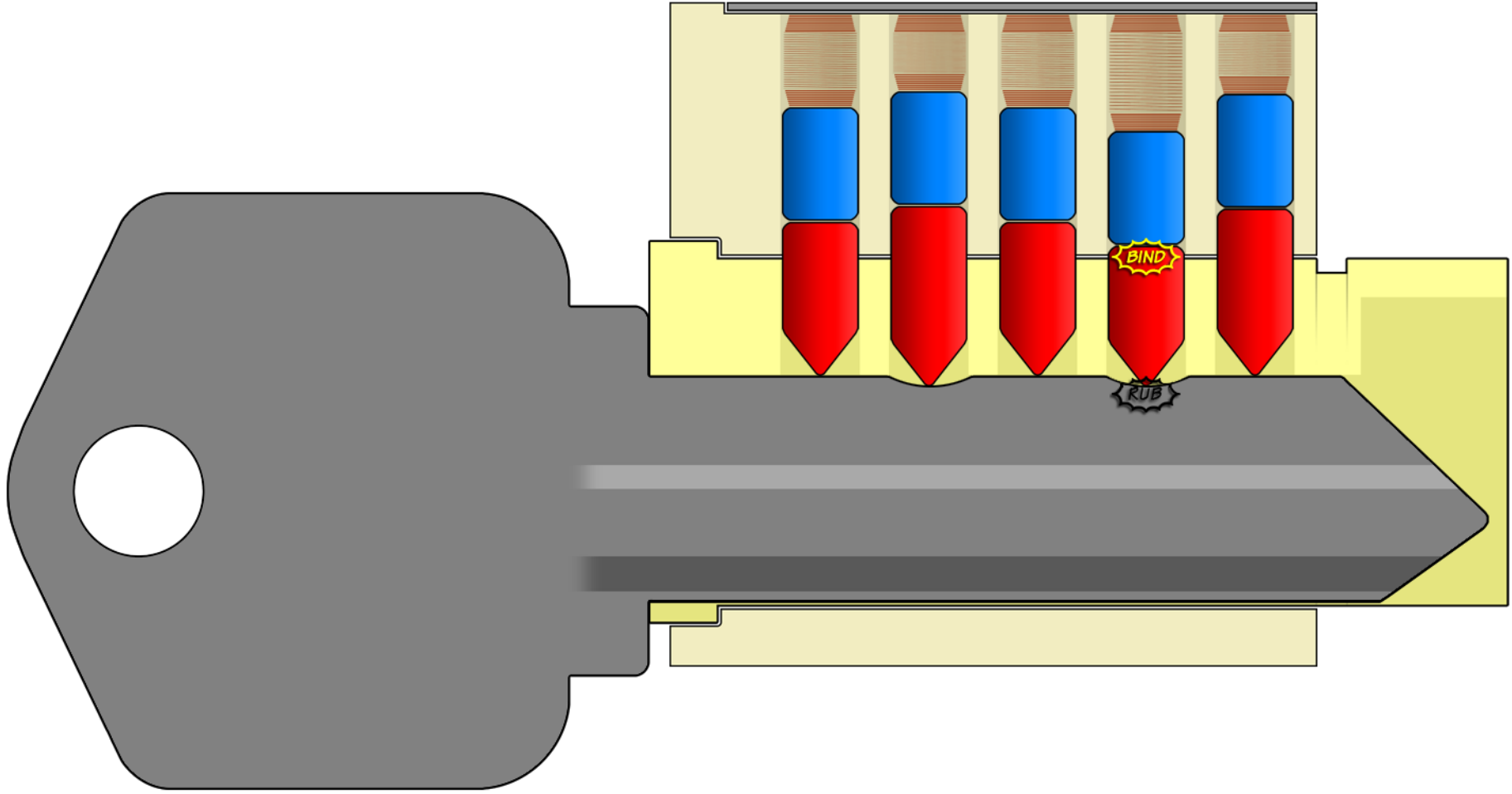

Impressioning - Stack 2 is still Binding

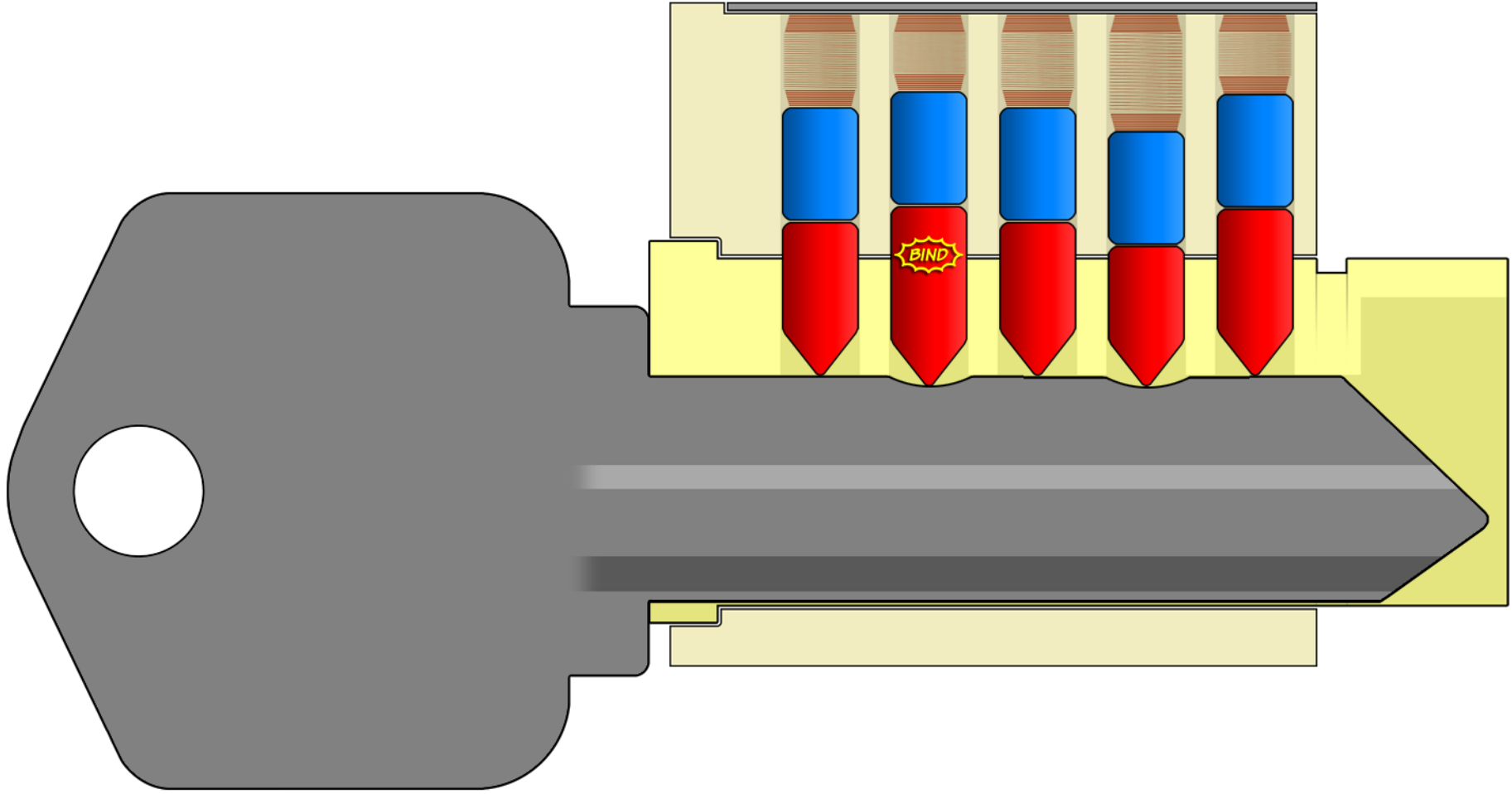

Impressioning - Stack 2 is still Rubbing

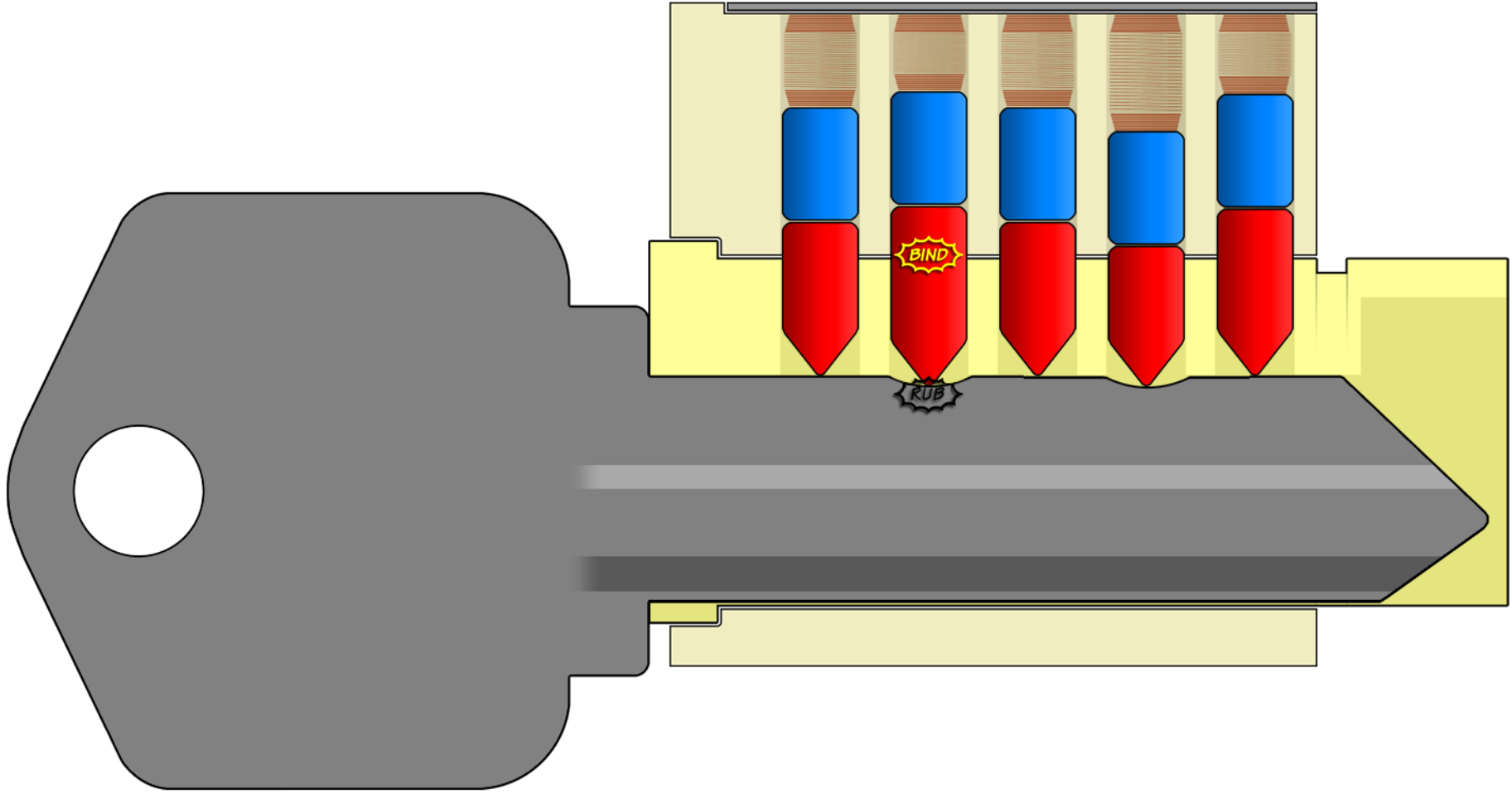

Impressioning - Continued Rub Marks

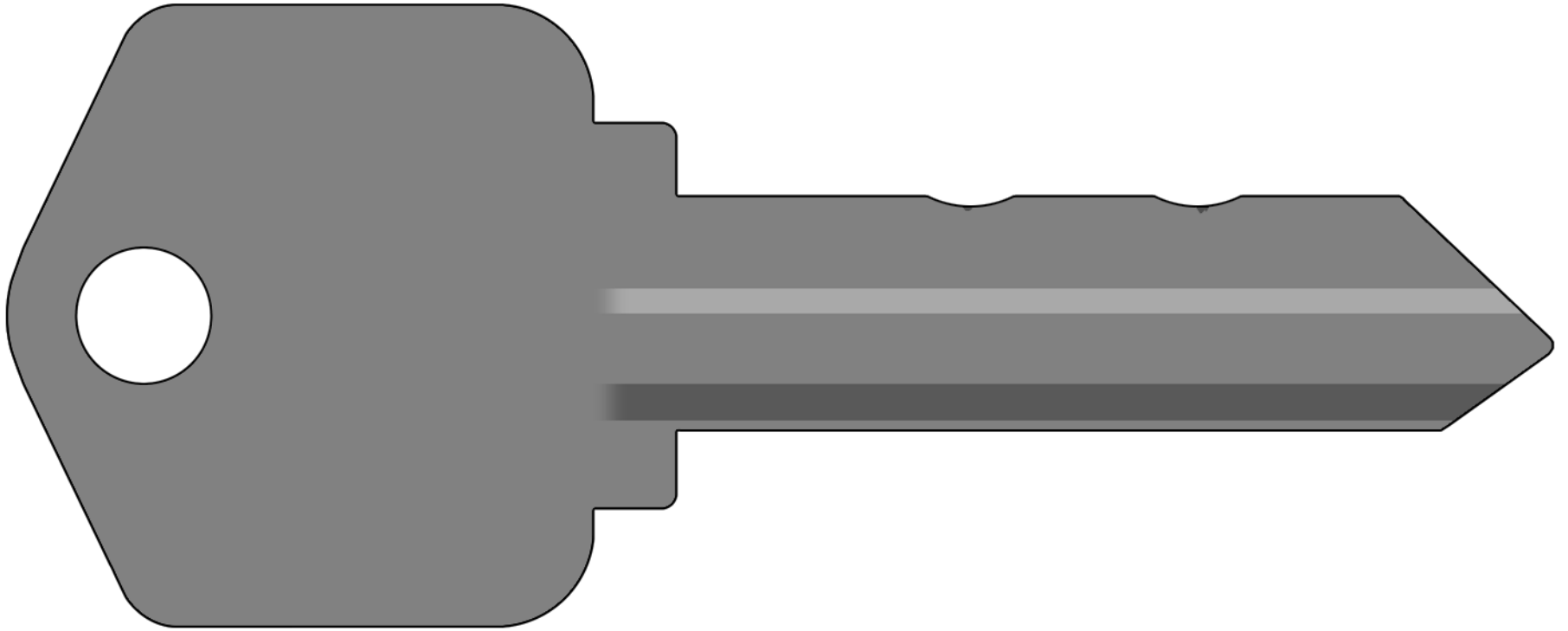

Impressioning - Continued Rub Marks

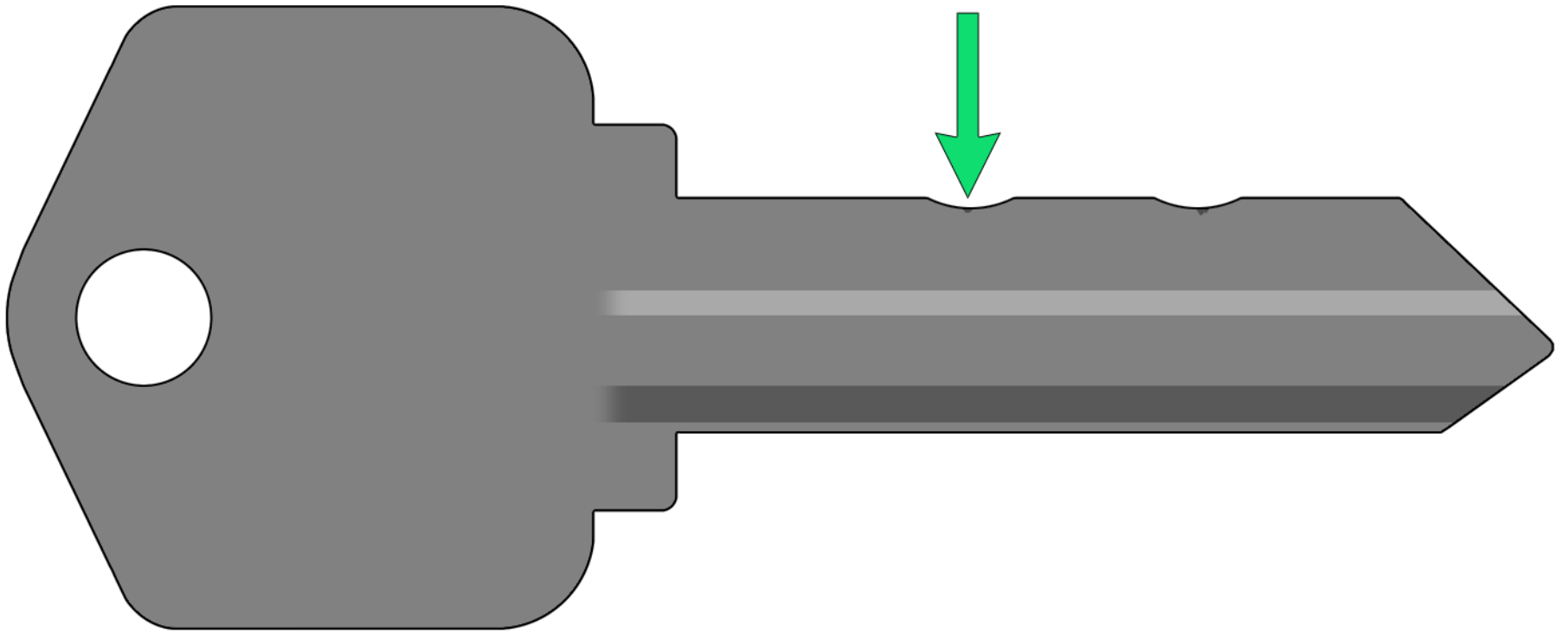

Impressioning - Continued Rub Marks

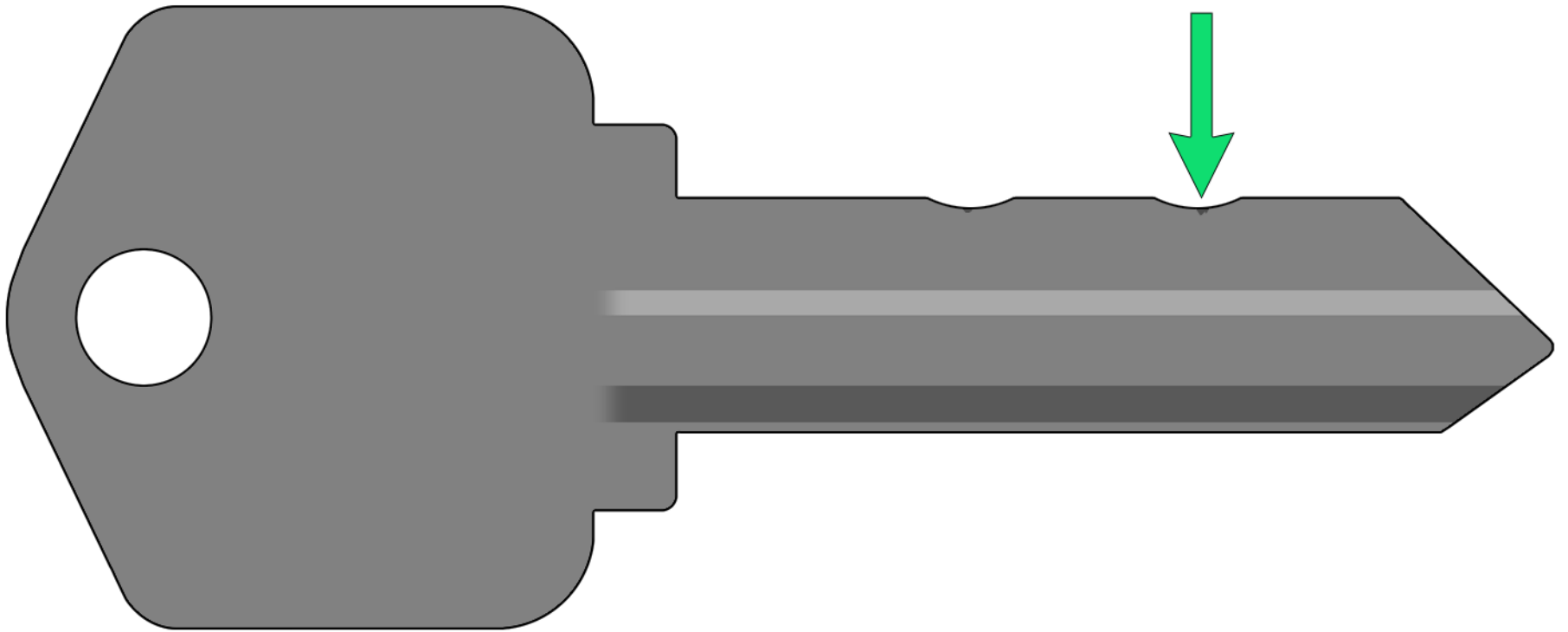

Impressioning - Continued Filing

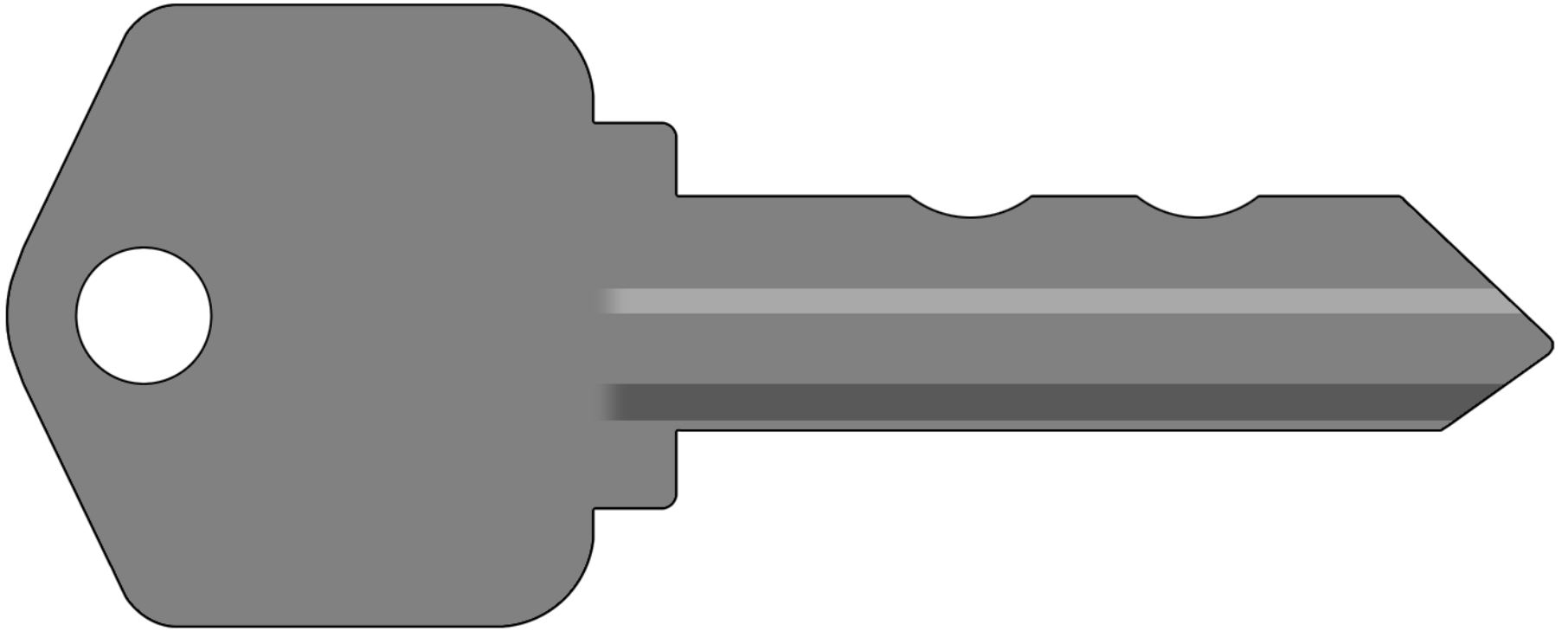

When the Key is Inserted Now..

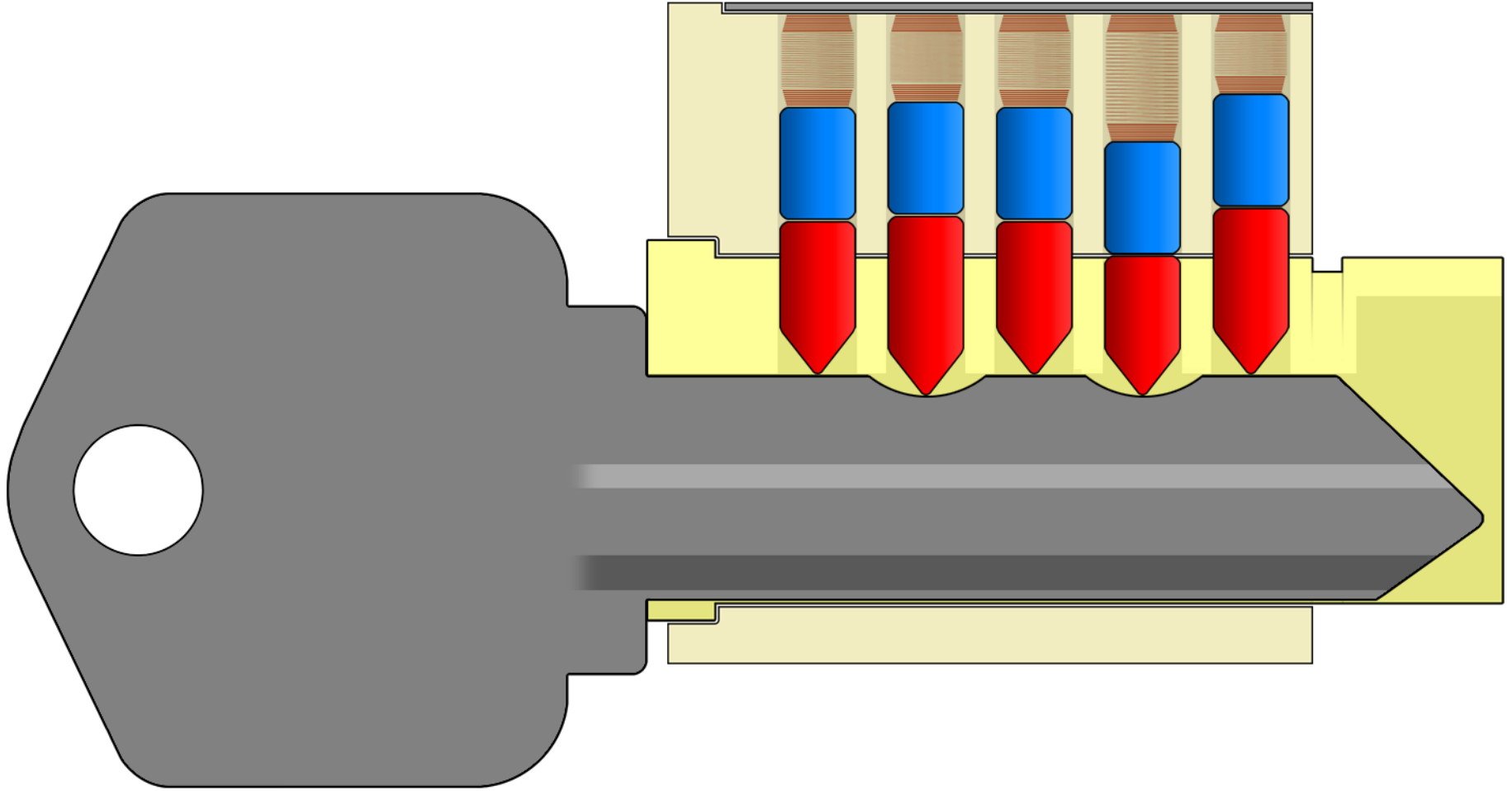

Pin Stack Number 4 is No Longer Binding

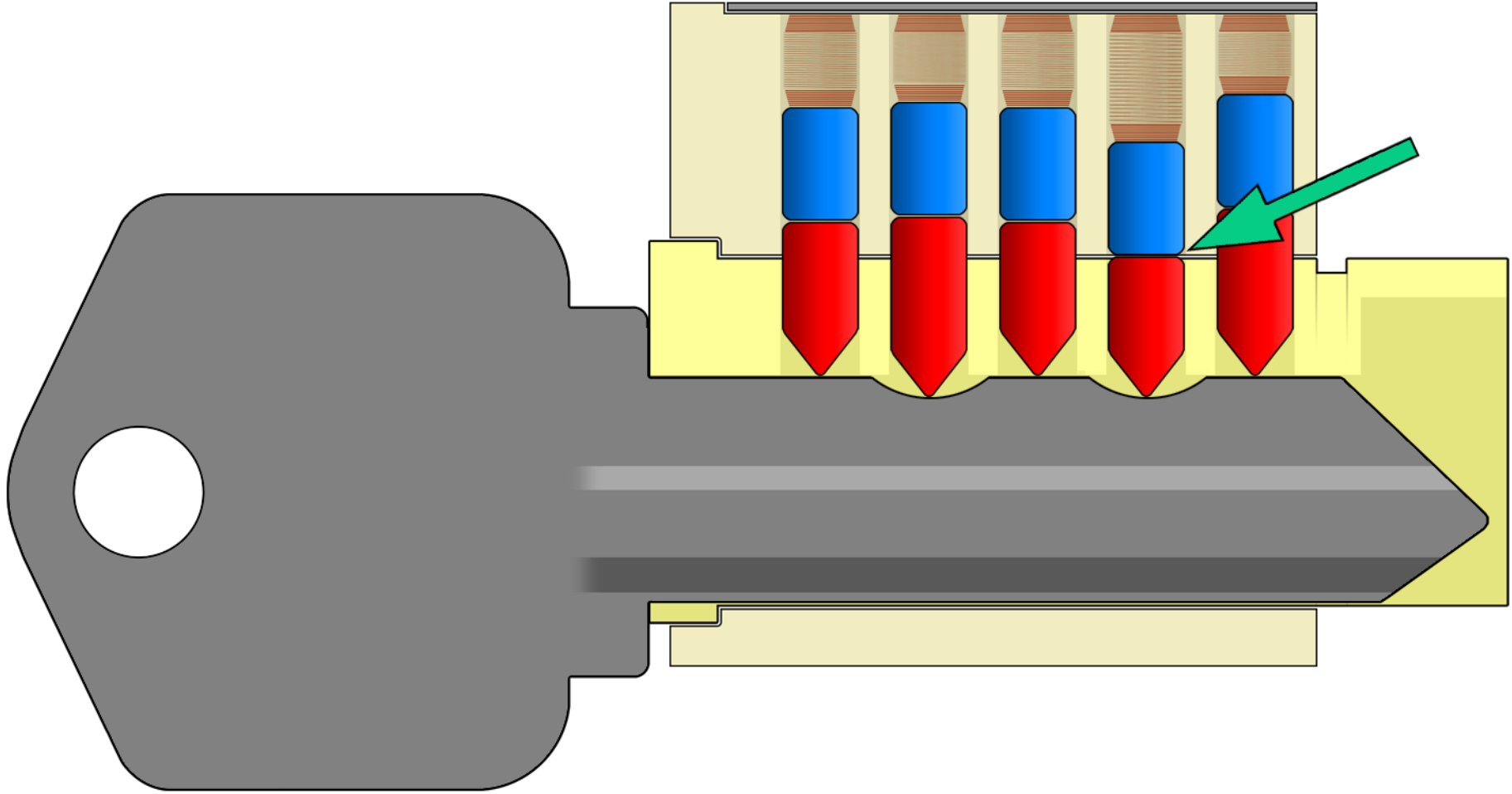

You'll Know This Has Happened

When *New* Marks Appear

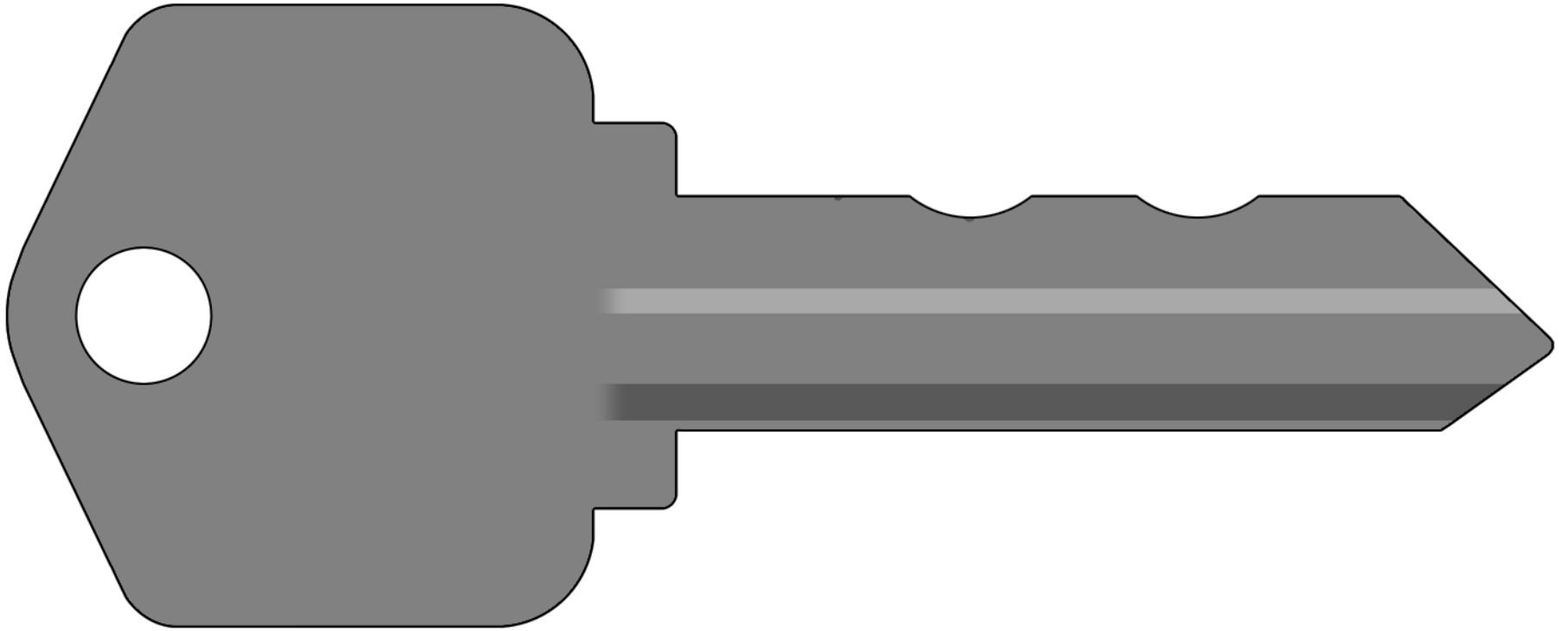

You'll Know This Has Happened

When *New* Marks Appear

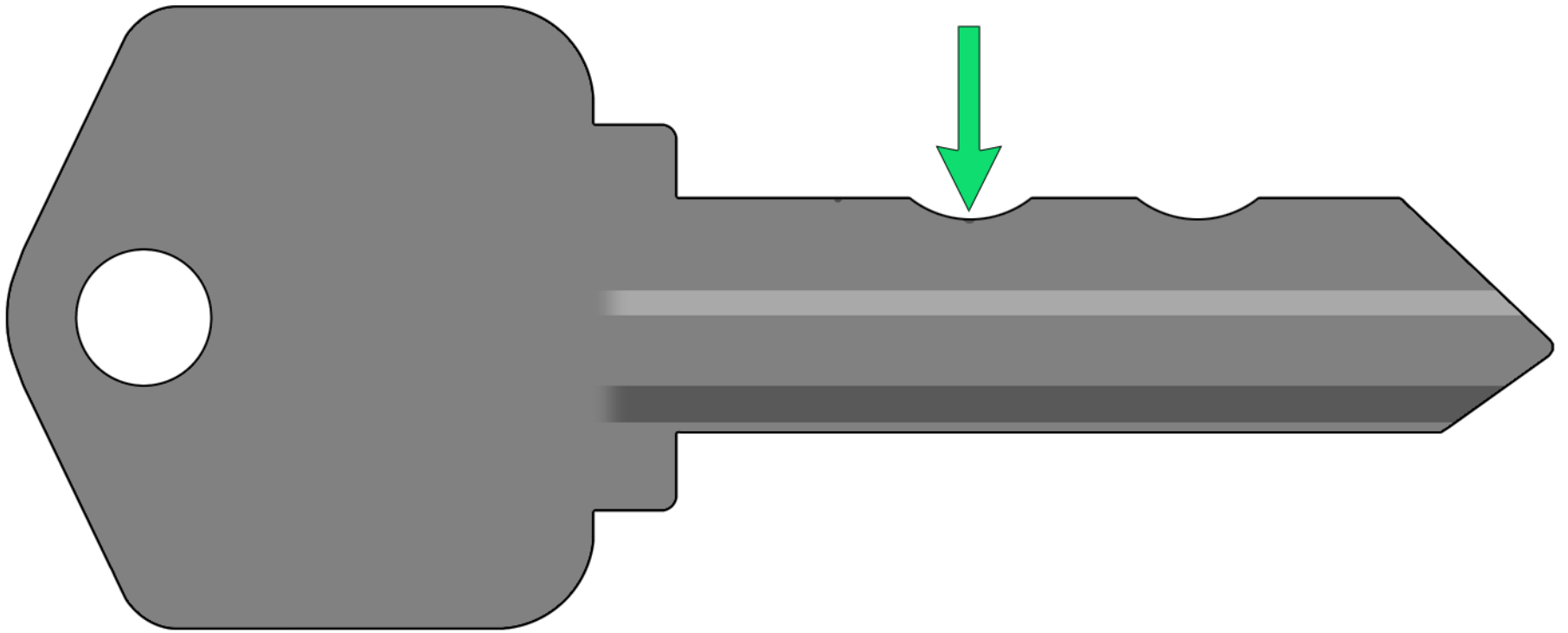

You'll Know This Has Happened

When *New* Marks Appear

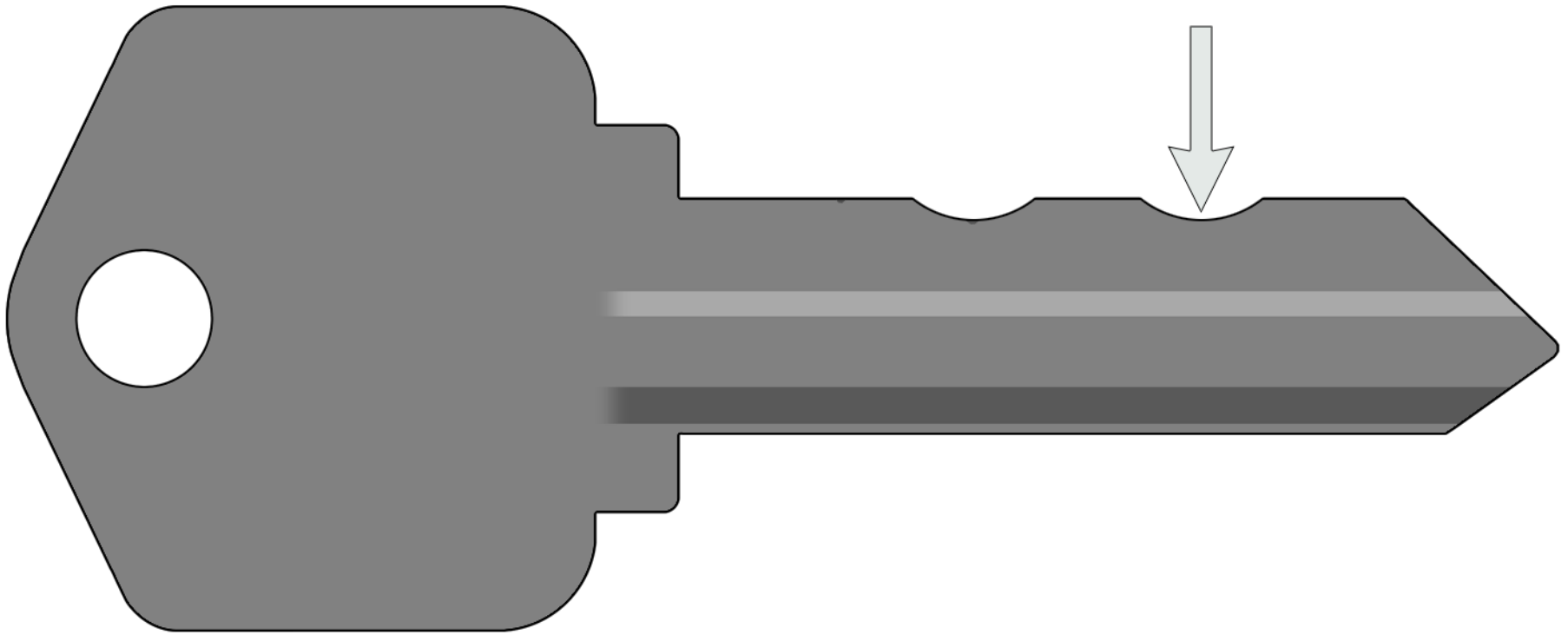

You'll Know This Has Happened

When *New* Marks Appear

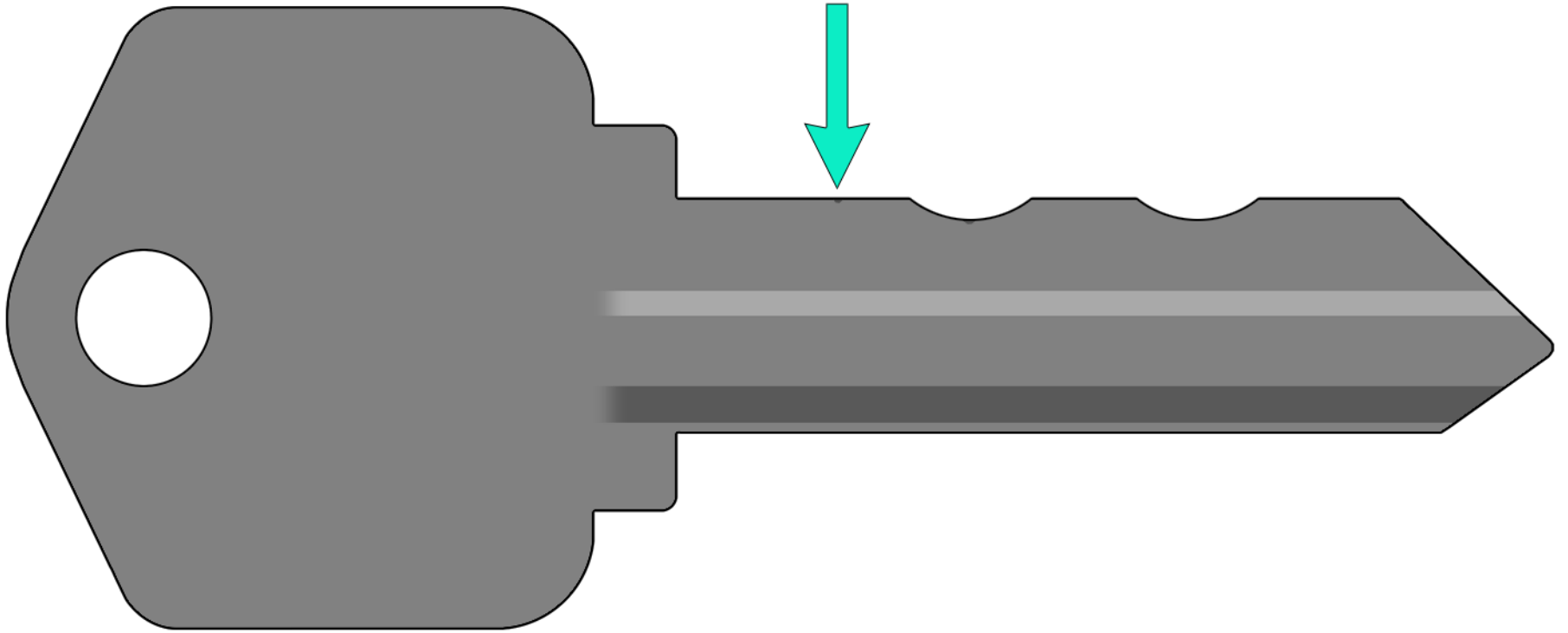

You'll Know This Has Happened

When *New* Marks Appear

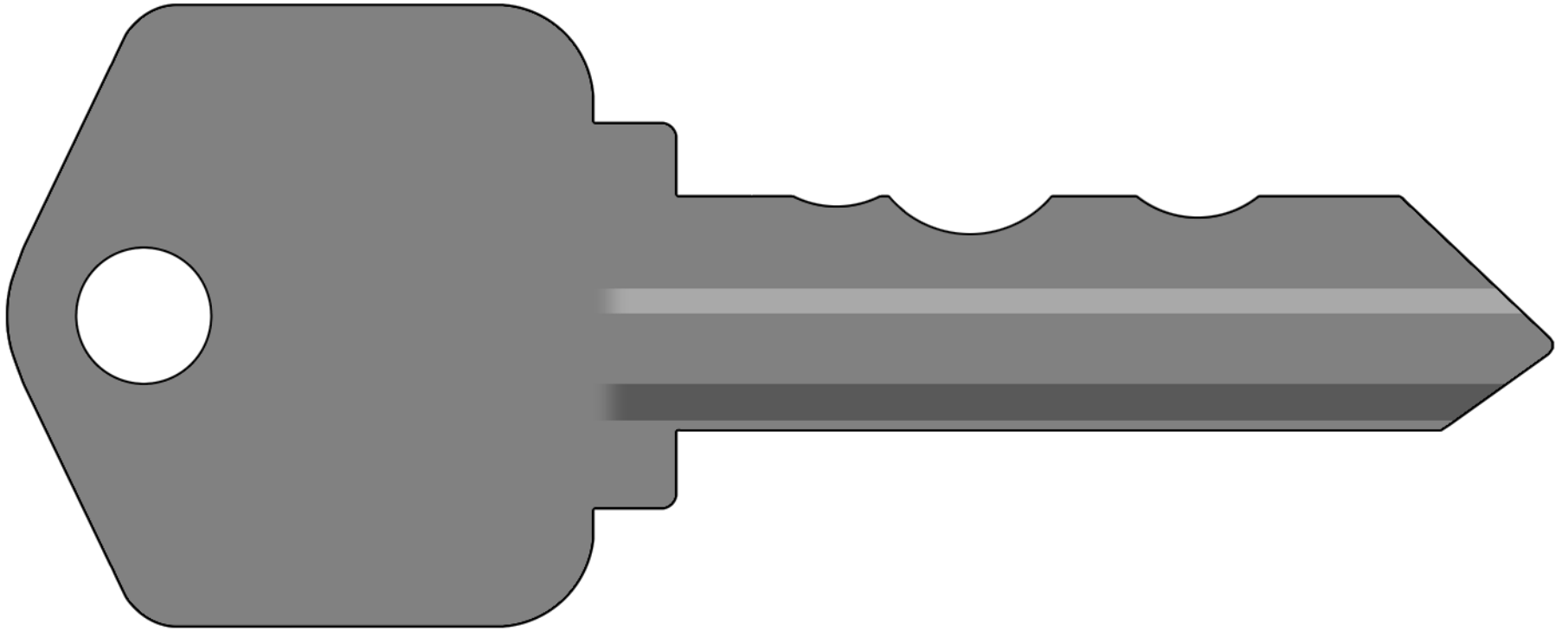

It's Delicate & Intricate Work



It's Delicate & Intricate Work



It's Delicate & Intricate Work



It's Delicate & Intricate Work



It's Delicate & Intricate Work



Open !

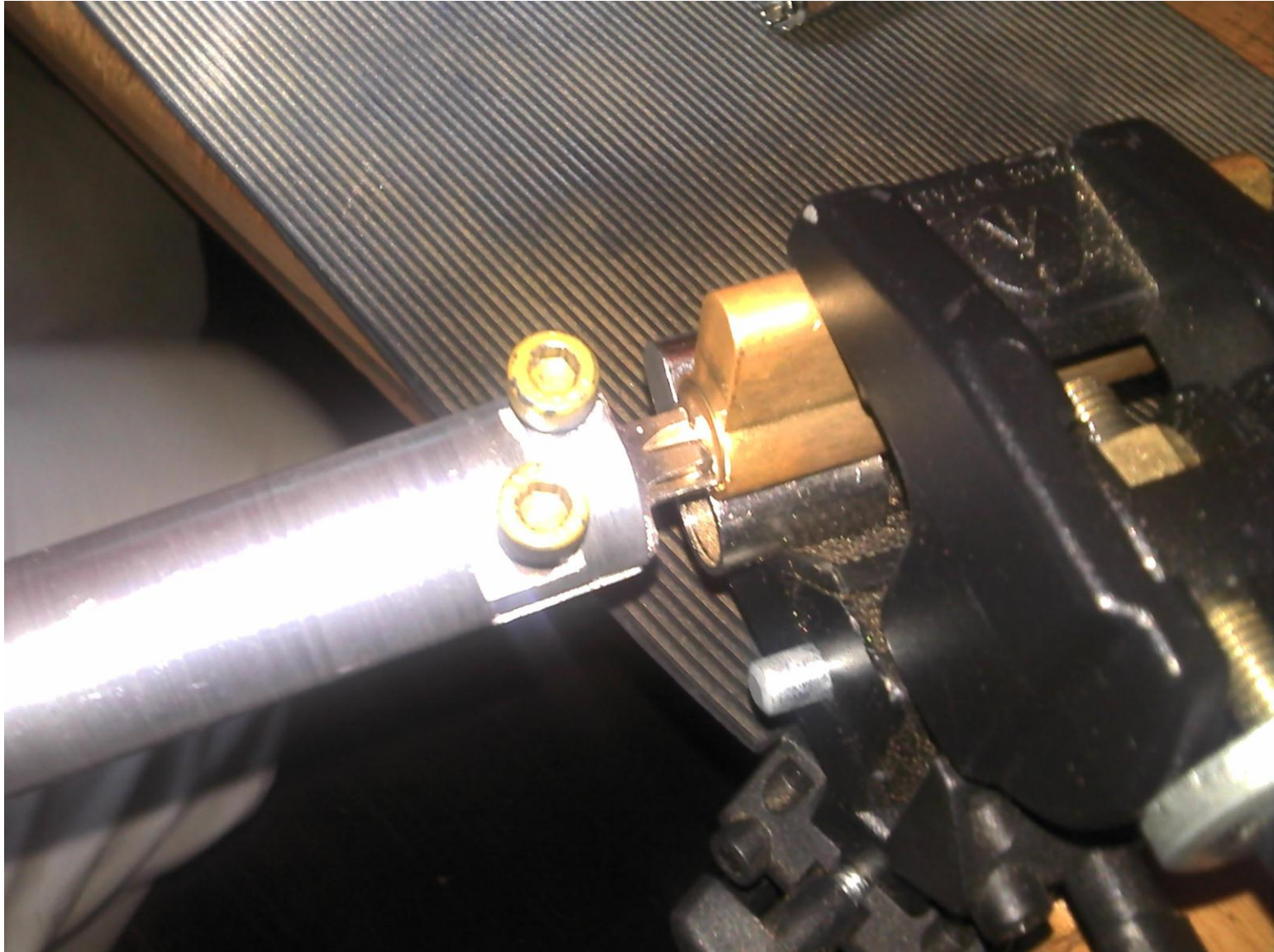

Open!



Open !



Impressioning Competitions



Impressioning Competitions

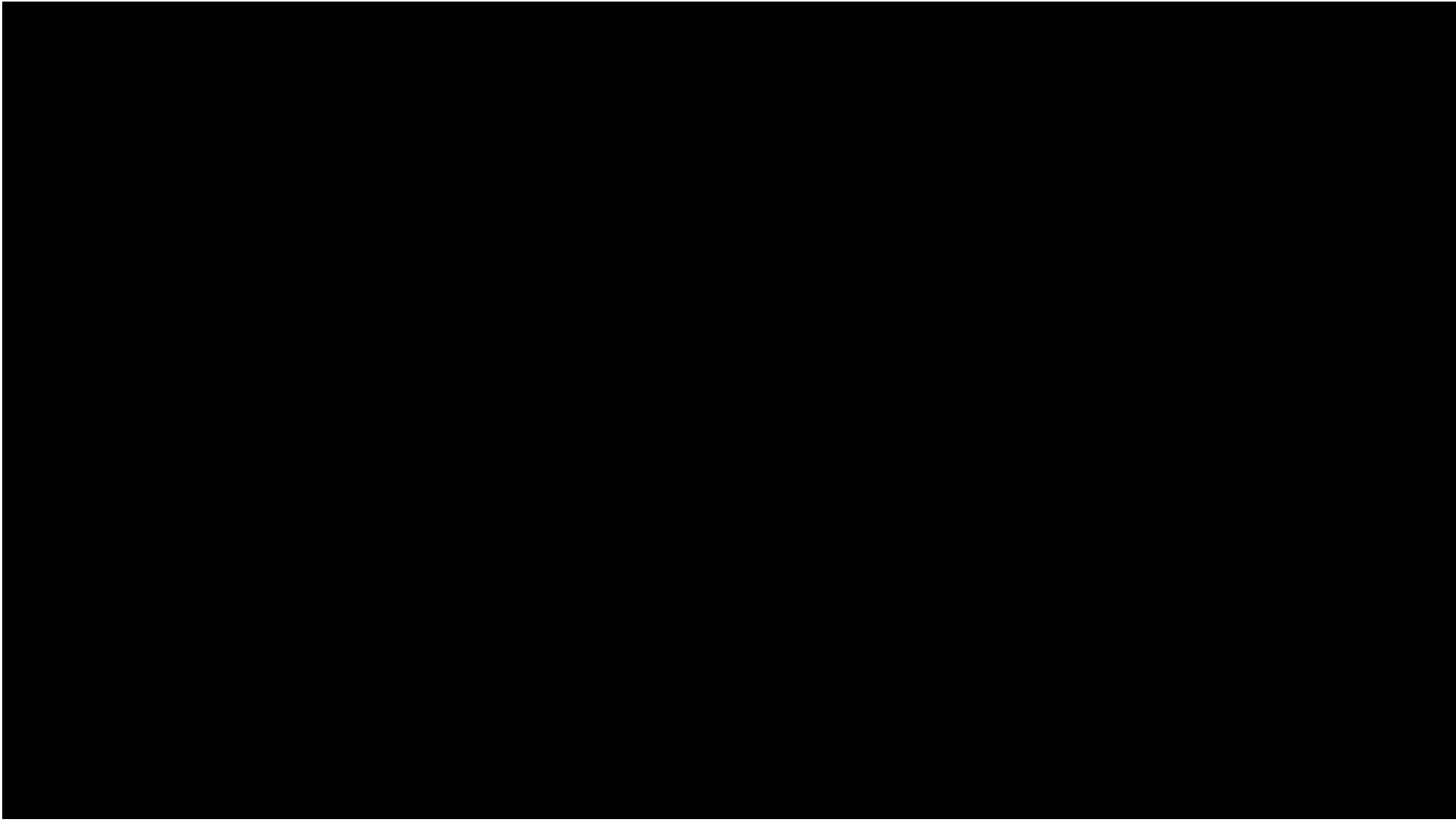

Impressioning Competitions



Questions?

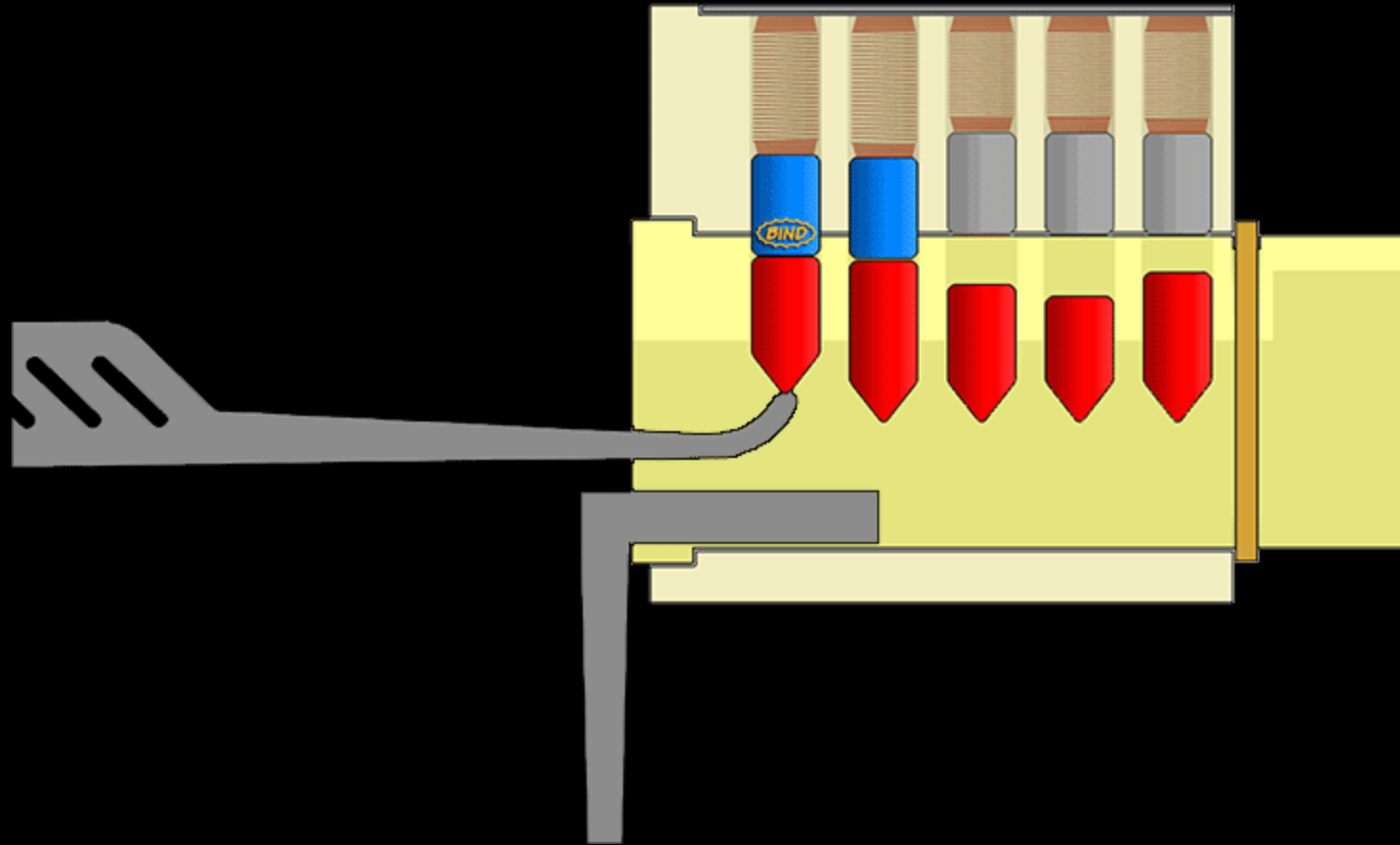

Master-Keyed Systems

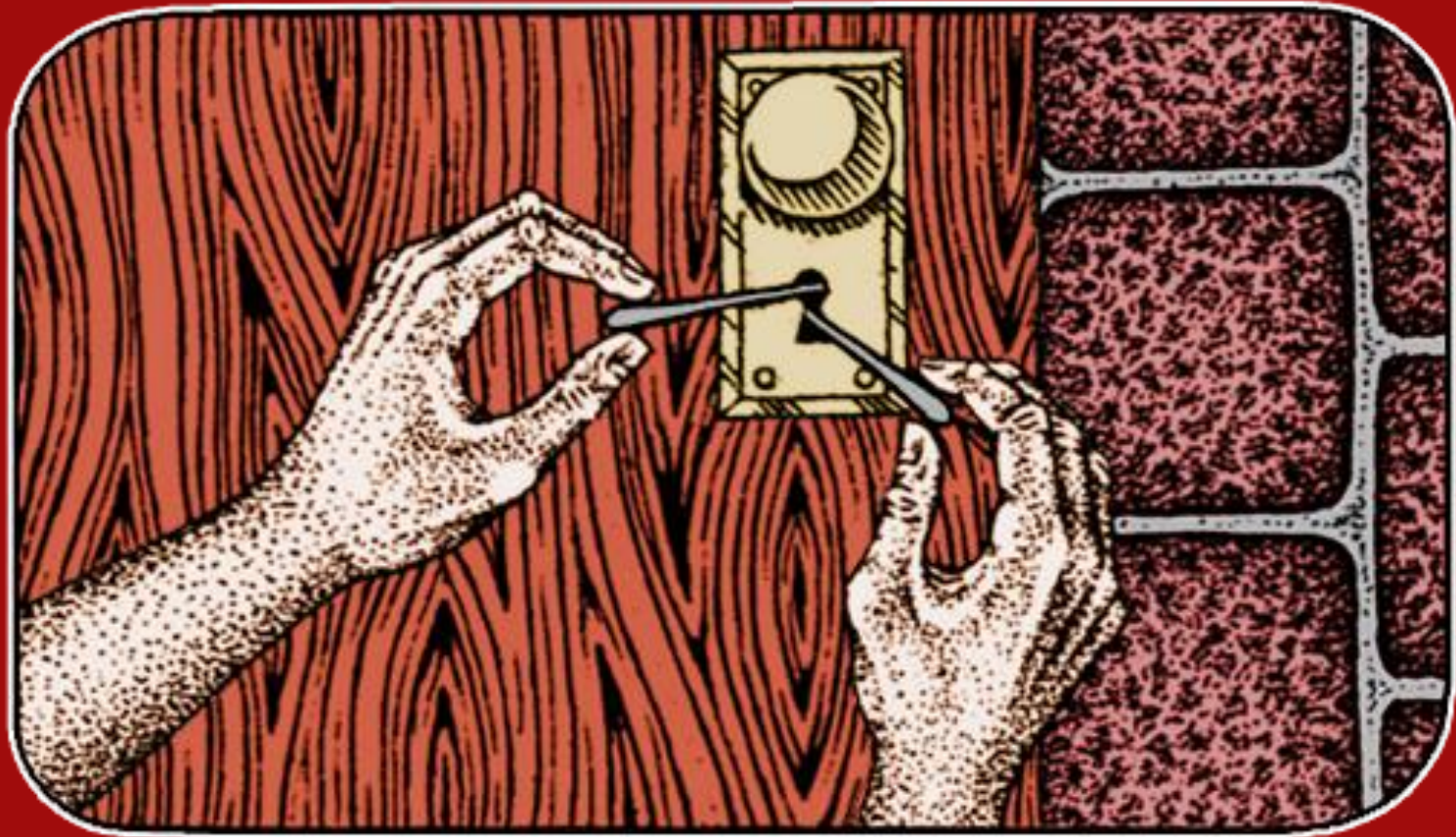

Master-Keyed Systems

- Varied permissi
- Sometimes keywa
- Privilege Escal



Master-Keyed Systems

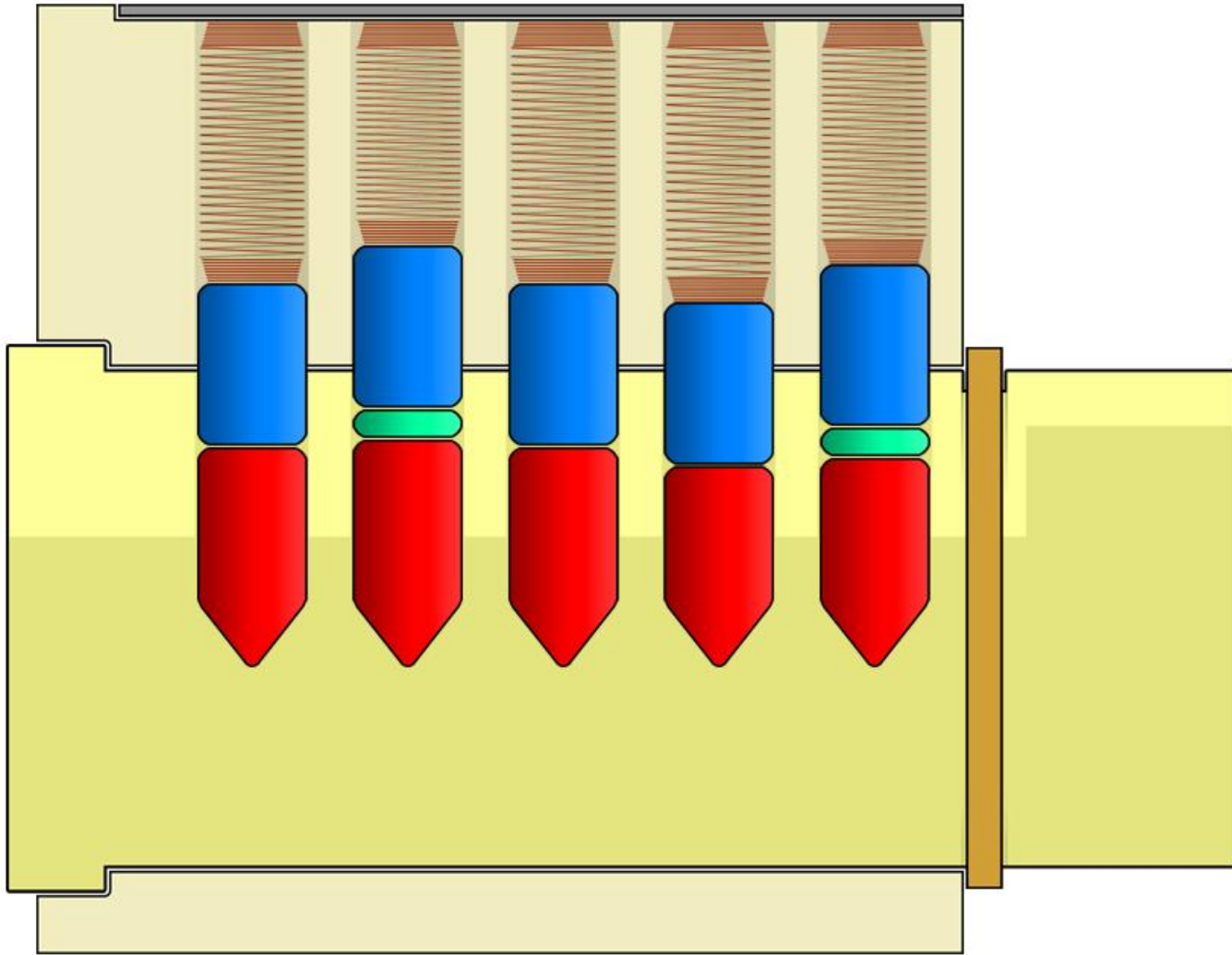

Master-Keyed Systems

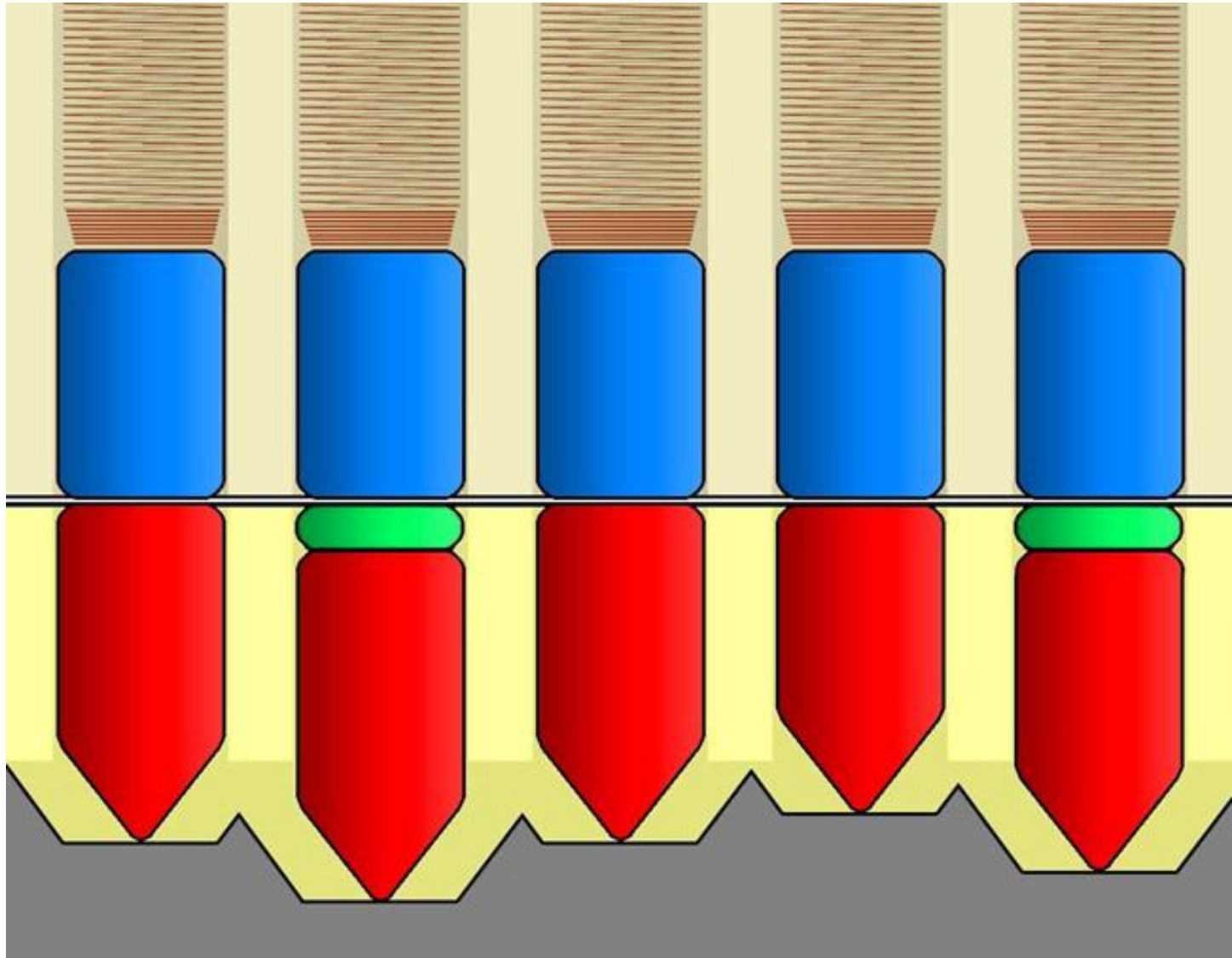

Master-Keyed Systems

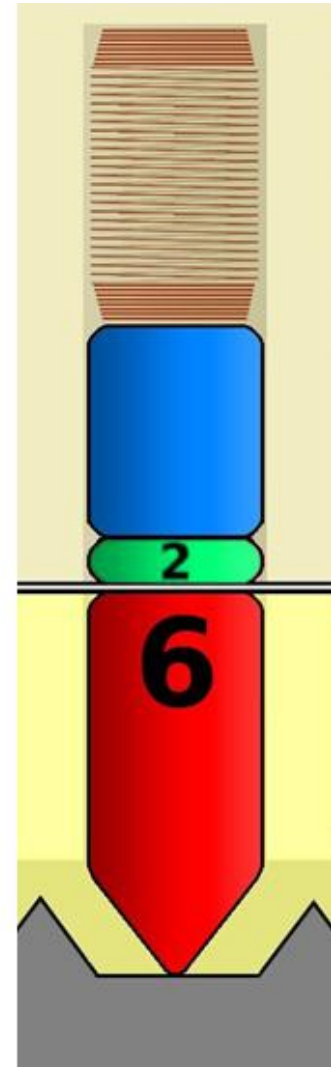
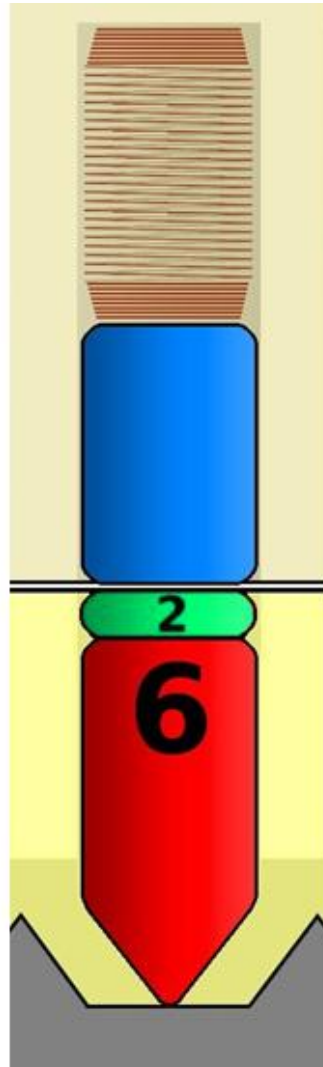
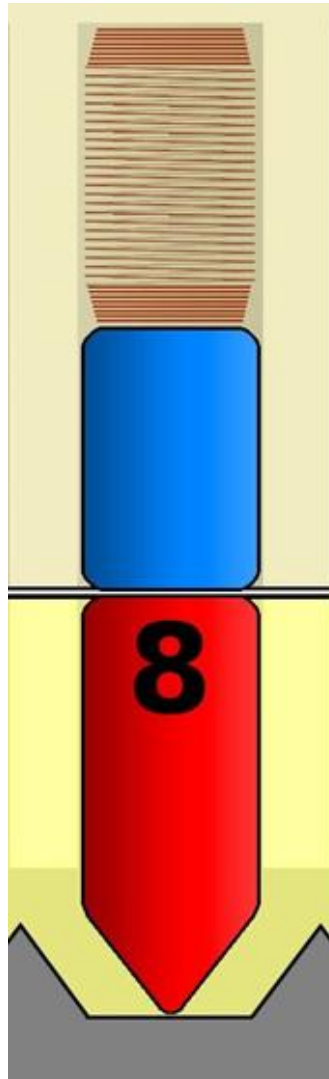

Finding the Master Biting

Depth

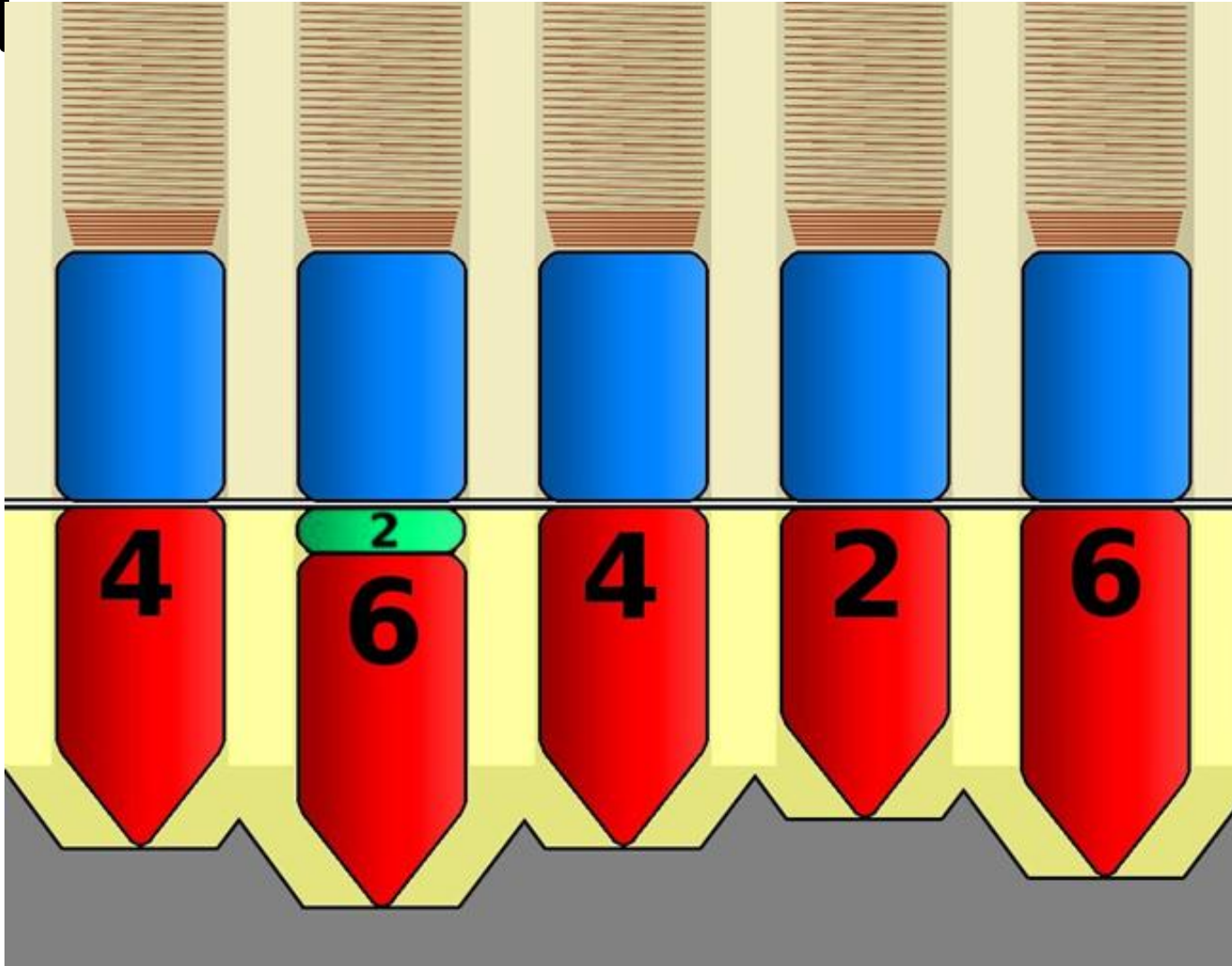

⚔ *Original key cut*

Lock opens <http://to...>

Finding the Master Biting

Depth

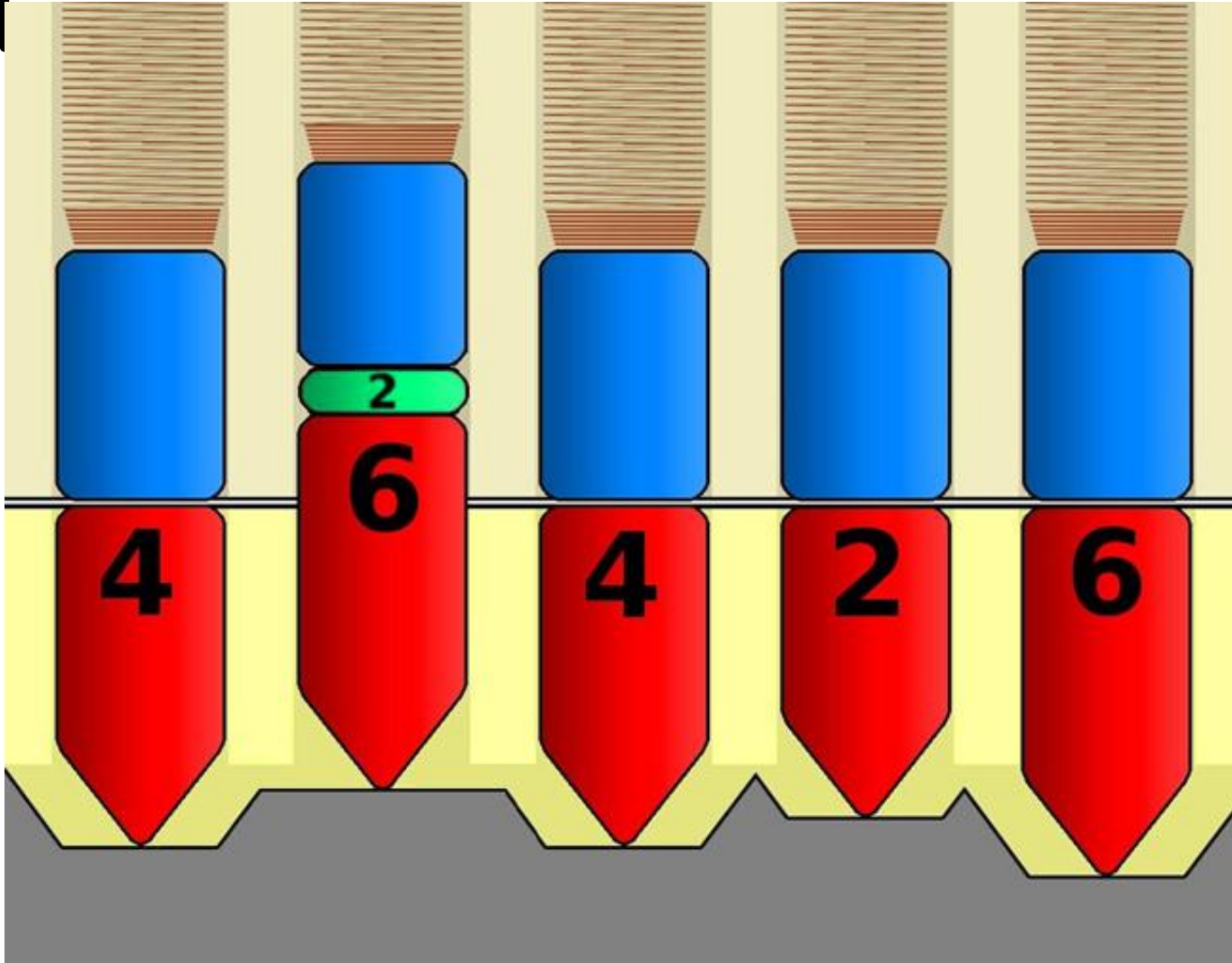

□ *Leave this position*

Lock does not <http://to...>

Finding the Master Biting

Depth

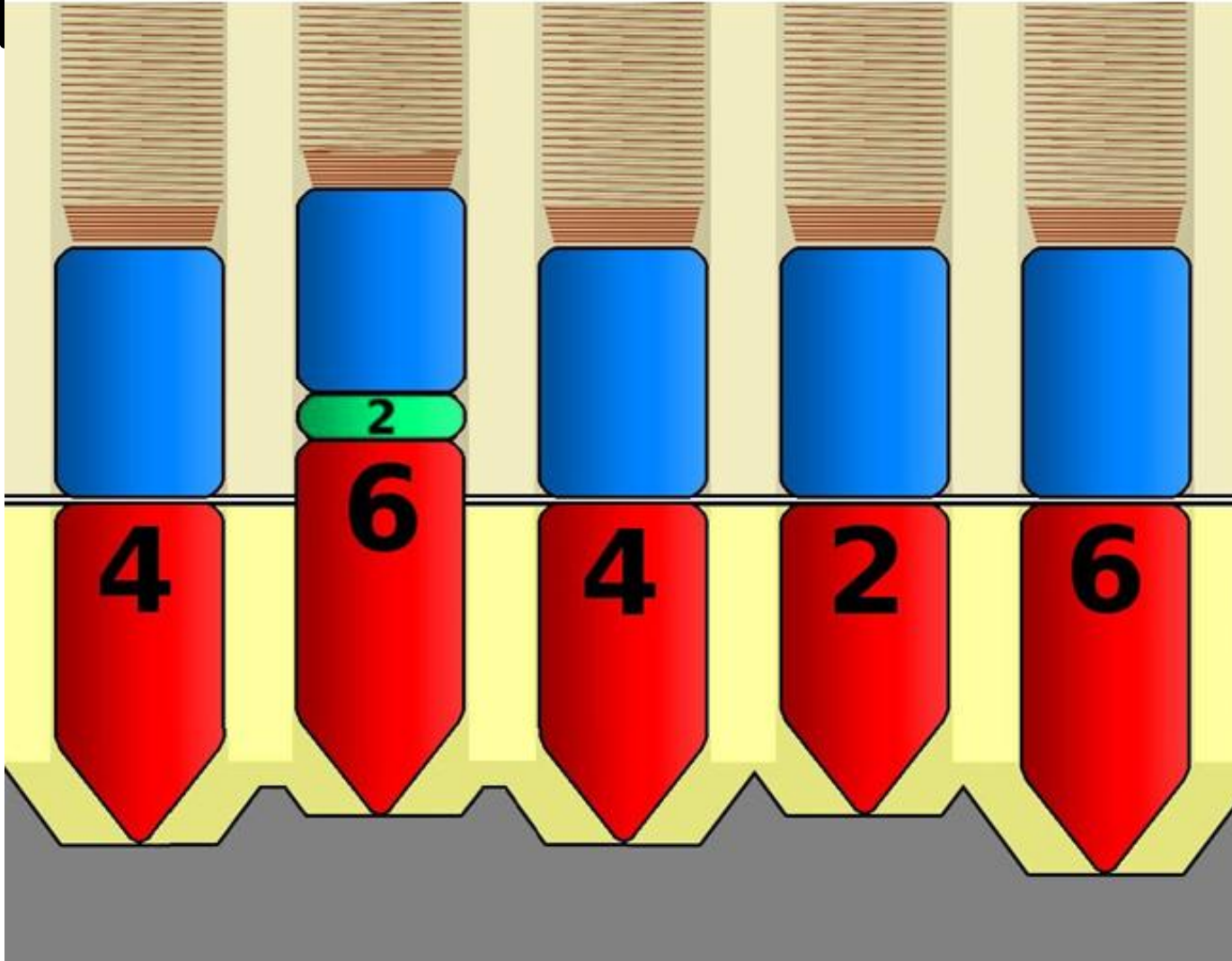

2 Cut down slightly...

Lock does not open <http://to...>

Finding the Master Biting

Depth

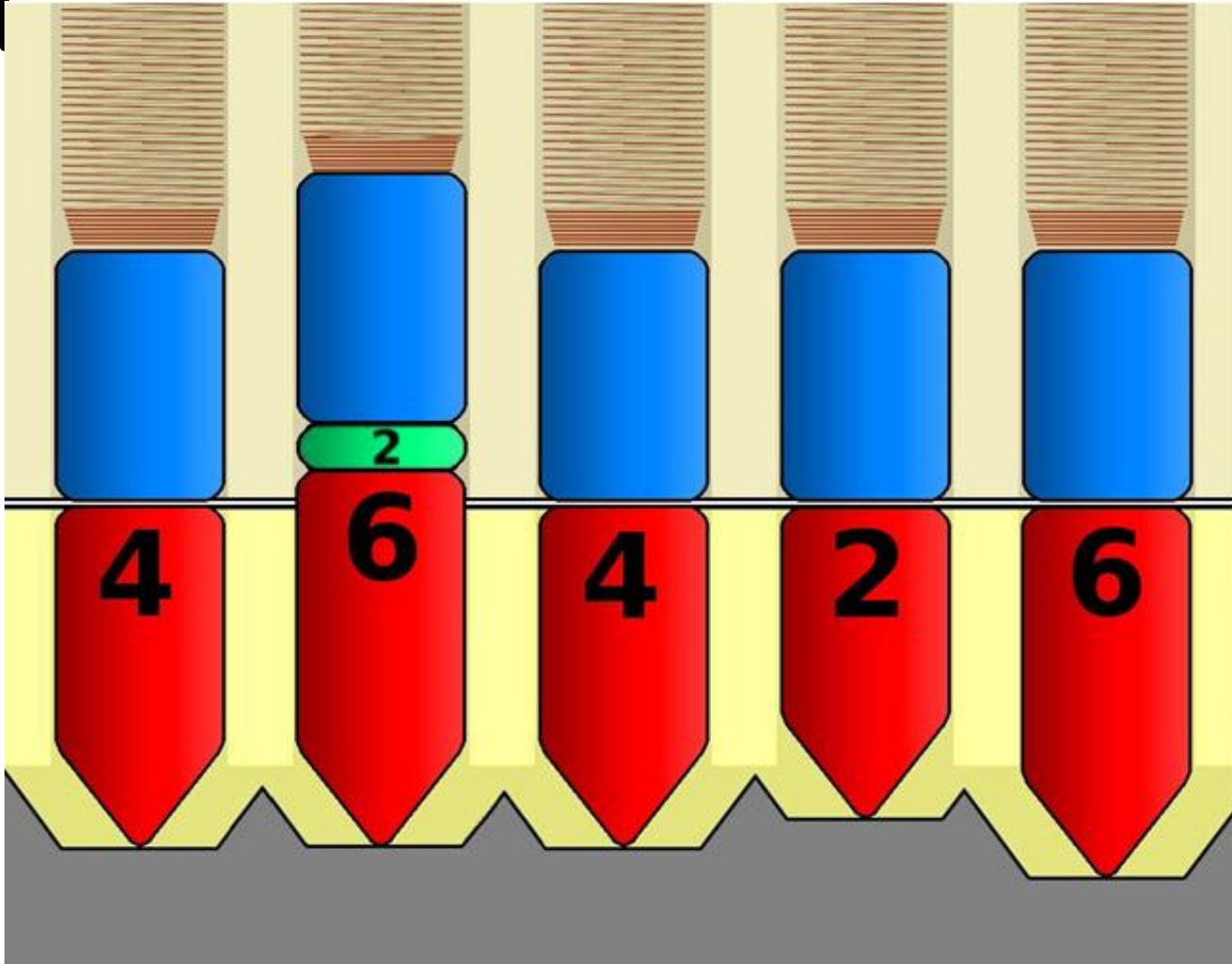

4 *Cut down a little*

Lock still does <https://to...>

Finding the Master Biting

Depth

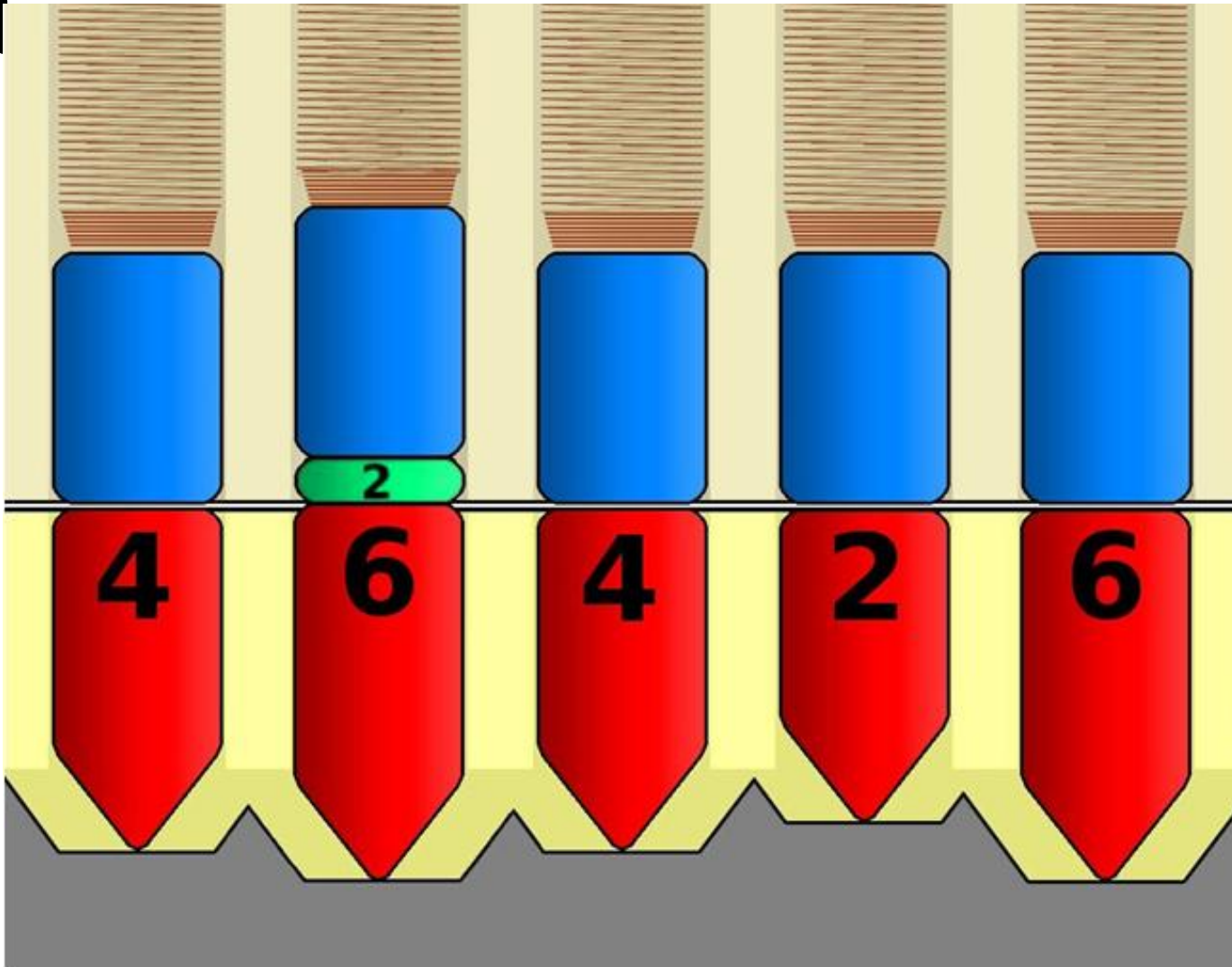

↳ Cut down more... *Lock opens!*

Finding the Master Biting Depths



“Master-Keyed Lock
Vulnerability”

by Matt Blaze
2003-01-27

<http://www.cryptoc.com/papers/mk.pdf>

<http://www.cryptoc.com/masterkey.html>

Questions?

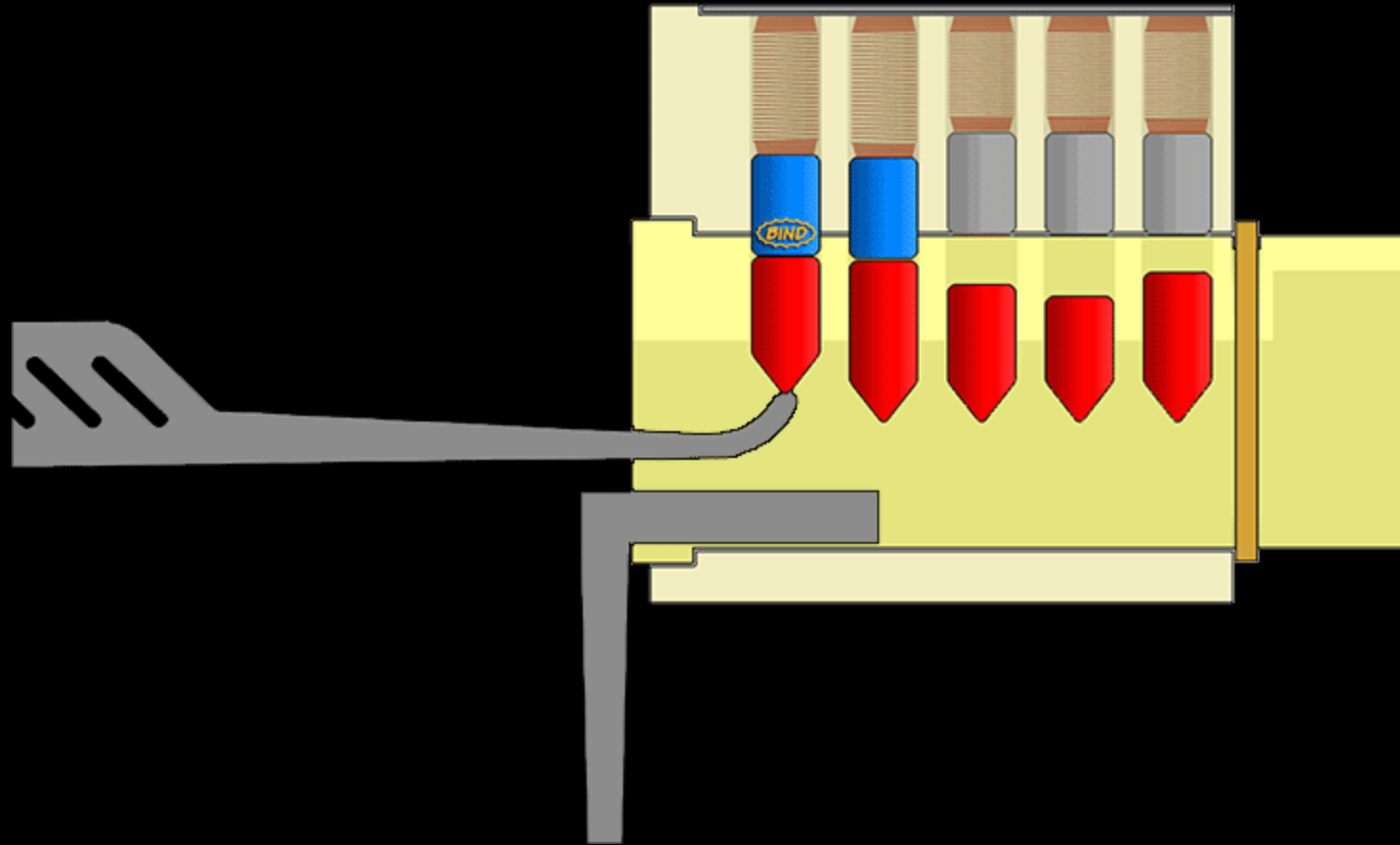

Distinguishing Picks

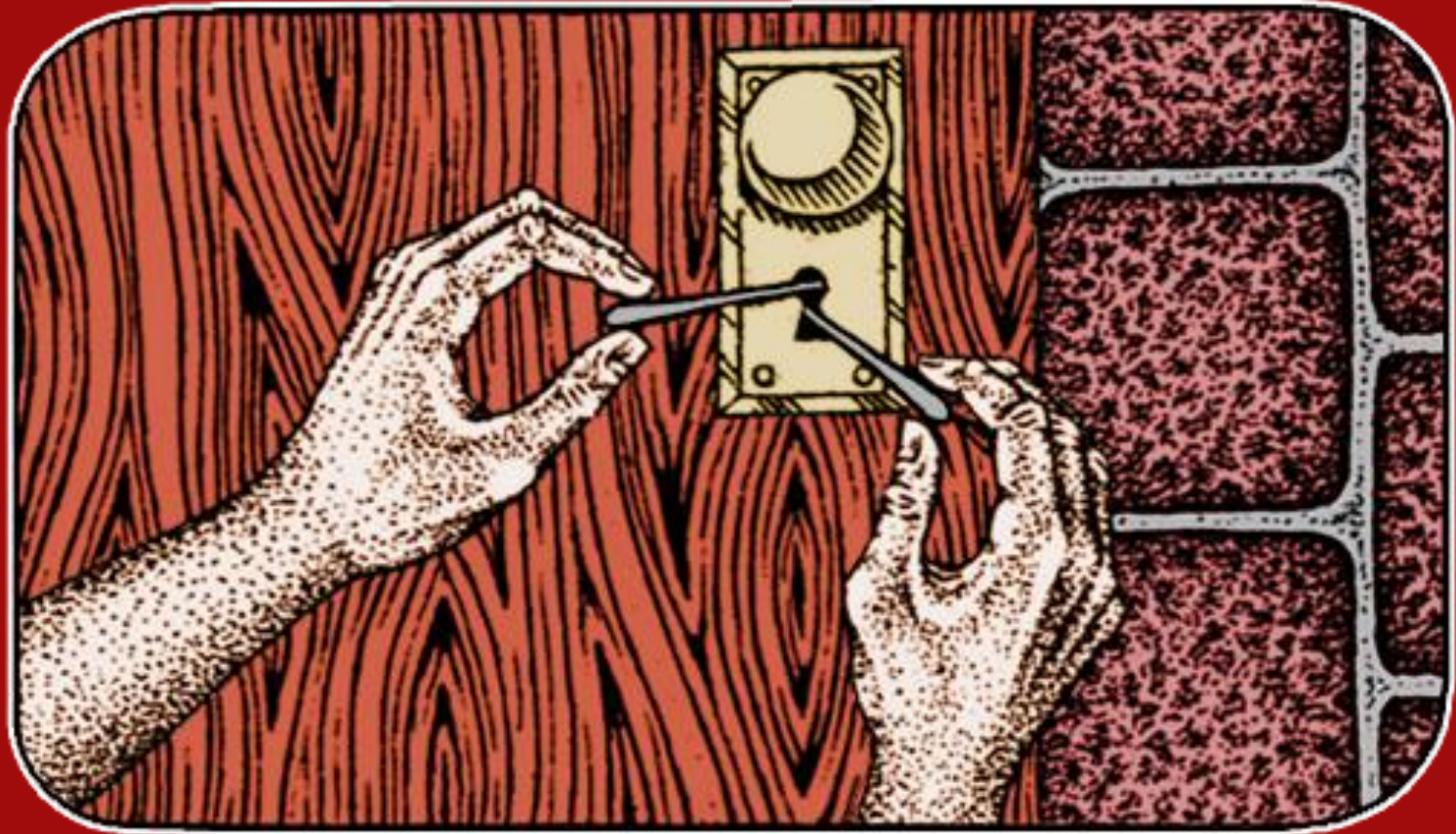

There are many lockpick vendors...

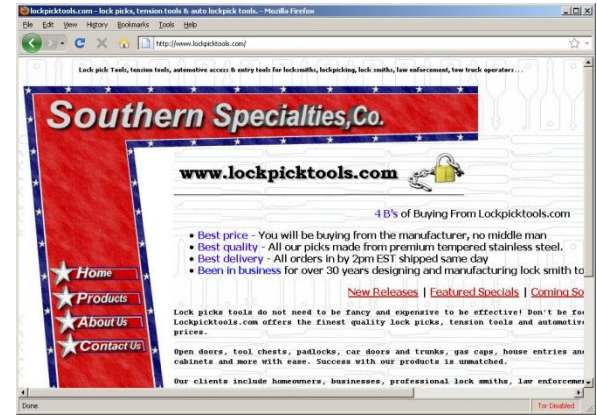
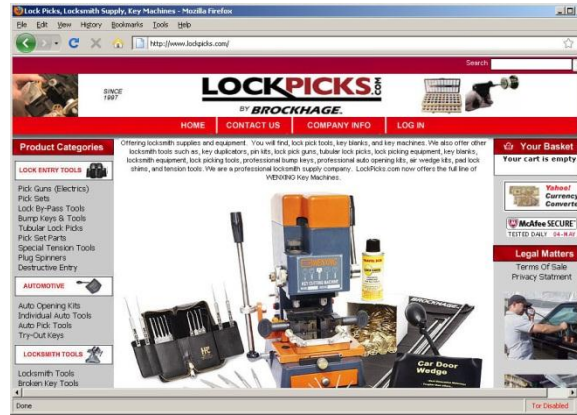

There are many lockpick vendors...



hpc world
Designer and Manufacturer of Locksmithing Equipment Since 1956

PRODUCT INFORMATION

- Key Machines
- Key Machine Accessories
- Code Cards
- Software
- Car Openers
- Pick Sets
- Tools
- Security Storage
- Door Guards

May through May 31, 2010
May Springtime Sale!
Click here to find out what's going on in May!

Have you seen...
HPC Sales Policy
Distributors
Calendar of Events
Instructions
Software Support
HPC

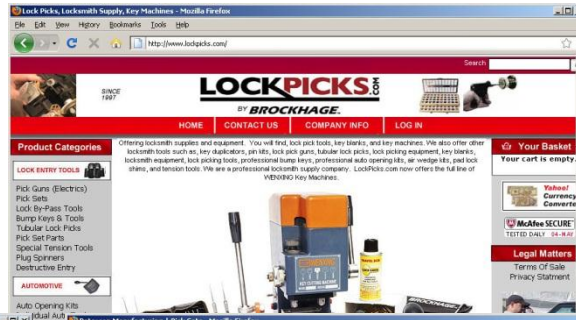

LOCKPICKS.COM
BY BROCKHAGE

HOME CONTACT US COMPANY INFO LOG IN

Product Categories

- LOCK ENTRY TOOLS
- Pick Guns (Electrics)
- Pick Sets
- Lock Bypass Tools
- Bump Keys & Tools
- Tubular Lock Picks
- Pick Set Parts
- Special Tension Tools
- Plug Spinners
- Disturbive Entry
- Auto Opening Kits

Offering locksmith supplies and equipment. You will find, lock pick tools, key blanks, and key machines. We also offer other locksmith tools such as, key duplicators, pin sets, lock pick guns, tubular lock picks, lock picking equipment, key blanks, locksmith equipment, lock picking tools, professional tuning kits, professional auto opening kits, air wrench kits, and lock stands, and tension tools. We are a professional locksmith supply company. LockPicks.com now offers the full line of VIKING Key Machines.

Your cart is empty

Phobos? Currency Converter
McAfee SECURE TESTED ONLY 04-14-10
Legal Matters Terms Of Sale Privacy Statement



Southern Specialties, Co.

www.lockpicktools.com

4 B's of Buying From Lockpicktools.com

- Best price - You will be buying from the manufacturer, no middle man
- Best quality - All our picks made from premium tempered stainless steel.
- Best delivery - All orders in by 2pm EST shipped same day
- Been in business for over 30 years designing and manufacturing lock smith to

New Releases | Featured Specials | Coming So



SOUTHORD
Manufacturer of Lock Picks & Professional Locksmith Tools

Lock Pick Categories

SouthOrd Professional Lock Picks

Welcome! Our Quality Featured Items Contact:

Quality, Reliability, Innovation, Value, and Service

have made SouthOrd® the industry leader in stainless steel professional locksmith tools. SouthOrd Lock Picks are manufactured of Full Hard Spring Stainless Steel - only one of the reasons we are supplier to locksmiths and repo men worldwide, governmental agencies both domestic and foreign, elite military units including Navy Seals Teams and other Special Ops Forces, the 101st and 502nd Airborne, and law enforcement agencies, Federal, State, and Local. If you fall into one of the previously mentioned job fields, Click Here for Associated Discounts.

Our new SouthOrd MAX® Lock Picks are made of the strongest and most durable stainless steel in the world, High Yield, with a minimum tensile strength of 270,000 PSI. We are honored to have gained the confidence of so many, and we welcome you into the family of SouthOrd Locksmith Tools.

SouthOrd Quality Locksmith Tools include our popular Tubular Lock Picks, SouthOrd Electric Picks and Snap Guns, Vehicle Entry Tools and more, and our extremely popular Jackknife Compact Lock Pick Set. A full range of lock picking instructional aids include lock picking books,



Peterson Locksmith Tools

Pick Sets

Our Pick Set offerings are arranged for practicality. You have the choice of ordering replacement "just pick" sets in a tube or complete pick sets with their quality leather case included. Locksmiths who have a desire for a molded plastic handle can get it here. Other Locksmiths will not be able to survive without our wonderfully firm molded rubber grips, or our textured dip handles. All of this is just if you already have a case that you wish not to part with!

- HOME
- Automotive
- Bump Keys
- Bypass Tools
- Extractors
- Drill Jigs
- 1 Core / R-Core Tools
- Individual Picks
- Opening Tools
- Pick Cases
- Pick Guns
- Pick Sets
- Pinning Tools

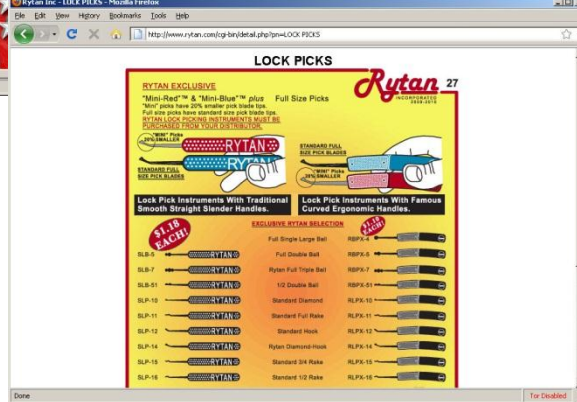

LOCK PICKS

RYTAN EXCLUSIVE "Mini-Red"™ & "Mini-Blue"™ plus Full Size Picks

Mini-Red™ and Mini-Blue™ plus Full Size Picks
Mini-Red™ and Mini-Blue™ plus Full Size Picks
Mini-Red™ and Mini-Blue™ plus Full Size Picks

LOCK PICK INSTRUMENTS WITH TRADITIONAL SMOOTH STRAIGHT BLANDER HANDLES

LOCK PICK INSTRUMENTS WITH FAMOUS CURVED ERGONOMIC HANDLES

Model	Brand	Description	Price
SLP-6	RYTAN	Full Single Large Ball	12.00
SLP-7	RYTAN	Full Double Ball	12.00
SLP-8	RYTAN	Rytan Full Triple Ball	12.00
SLP-9	RYTAN	1/2 Double Ball	12.00
SLP-10	RYTAN	Standard Full Rake	12.00
SLP-11	RYTAN	Standard Hook	12.00
SLP-12	RYTAN	Rytan Diamond Hook	12.00
SLP-13	RYTAN	Standard 24 Rake	12.00
SLP-14	RYTAN	Standard 12 Rake	12.00

There are many lockpick vendors...



h p c w o r l d
Designer and Manufacturer of Locksmithing Equipment Since 1956

PRODUCT INFORMATION

- Key Machines
- Key Machine Accessories
- Code Cards
- Software
- Car Openers
- Pick Sets
- Tools
- Security Storage
- Door Guards

May Springtime Sale
Click here to find out what's going on in May!

Have you seen...
HPC Sales Policy
Distributors
Software Support
Calendar of Events
Instructions



LOCKPICKS.com
BY BROCKHAGE

Product Categories

- LOCK ENTRY TOOLS
- Pick Guns (Electrics)
- Pick Sets
- Lock Bypass Tools
- Bump Keys & Tools
- Tubular Lock Picks
- Pick Set Parts
- Special Tension Tools
- Plug Spinners
- Destructive Entry

Offering locksmith supplies and equipment. You will find lock pick tools, key blanks, and key machines. We also offer other locksmith tools such as, key duplicators, pin sets, lock pick guns, tubular lock picks, lock picking equipment, key blanks, locksmith equipment, lock picking tools, professional auto opening kits, air wrench kits, and lock stands, and tension tools. We are a professional locksmith supply company. LockPicks.com now offers the full line of VEDICO Key Machines.



lockpicktools.com

Southern Specialties, Co.

4 B's of Buying From Lockpicktools.com

- Best price - You will be buying from the manufacturer, no middle man
- Best quality - All our picks made from premium tempered stainless steel.
- Best delivery - All orders in by 2pm EST shipped same day
- Been in business for over 30 years designing and manufacturing lock smith to

New Releases | Featured Specials | Coming So



SOUTHORD
Manufacturer of Lock Picks & Professional Locksmith Tools

SouthOrd Professional Lock Picks

Lock Pick Categories

- Automotive
- Bump Keys
- Rydan Tools
- Extractors
- Drill Jigs
- LCare / RCare Tools
- Individual Picks
- Opening Tools
- Pick Cases

Quality, Reliability, Innovation, Value, and Service
have made SouthOrd® the industry leader in stainless steel professional locksmith tools.



Peterson Locksmith Tools

Pick Sets

Our Pick Set offerings are arranged for practicality. You have the choice of ordering replacement "just pick" sets in a tube or complete pick sets with their quality leather case included. Locksmiths who have a desire for a molded plastic handle can get it here. Other Locksmiths will not be able to survive without our wonderfully firm molded rubber grips, or our textured dip handles. All of this is just if you already have a case that you wish not to part with!



LOCK PICKS

Rydan EXCLUSIVE

Mini-Red™ & Mini-Blue™ plus Full Size Picks

Lock Pick Instruments With Traditional Smooth Straight Blended Handles

EXCLUSIVE RYDAN SELECTION

Model	Description	Price
SLP-6	Full Single Large Ball	RRP: 6.95
SLP-7	Full Double Ball	RRP: 6.95
SLP-8	Rydan Full Triple Ball	RRP: 7.95
SLP-9	1/2 Double Ball	RRP: 6.95
SLP-10	Standard Diamond	RRP: 10.00
SLP-11	Standard Full Ball	RRP: 6.95

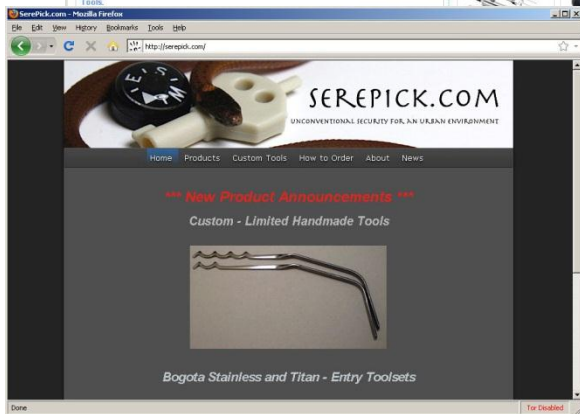

SEREPICK.COM
UNCONVENTIONAL SECURITY FOR AN URBAN ENVIRONMENT

New Product Announcements™™™
Custom - Limited Handmade Tools

Bogota Stainless and Titan - Entry Toolsets



LockPickShop.com

Lock Pick Combo Kit 1

Lock Pick Combo Kit 2

Lock Pick Combo Kit 3

Lock Pick Combo Kit 4

Special

QUESTIONS? Please leave a message

Category Info:

Our lock picking combo kits can't be beat. Jam-packed with the tools you need like SouthOrd lock pick sets, hand tools, locksmith training books and tools have been combined into "Proven" savings kits that are sure to please law enforcement personnel, locksmiths, lock picking hobbyists, enthusiasts and professionals alike. At a 45% below retail it's a sure way to get the most out of your lock picking kit!

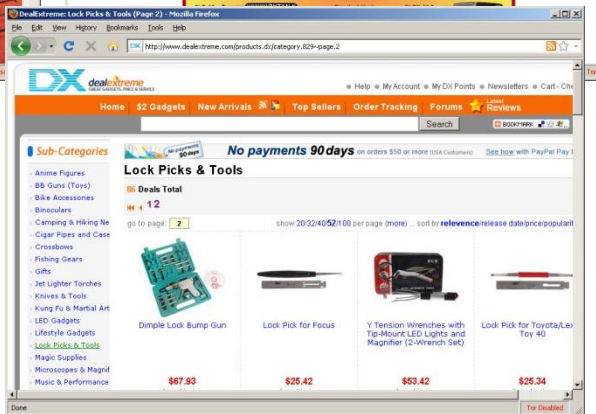

DX Deals

Lock Picks & Tools

No payments 90 days on orders \$50 or more USA Customers

Sub-Categories

- Anime Figures
- BB Guns (Toys)
- Bike Accessories
- Bicycles
- Camping & Hiking Gear
- Cigar Pipes and Case
- Crossbows
- Fishing Gears
- Gifts
- Jet Lighter Torches
- Knives & Tools
- Kung Fu & Martial Art
- LED Gadgets
- Lifestyle Gadgets
- Lock Picks & Tools
- Magic Supplies
- Monocopes & Magnif
- Music & Performance

Deals Total 12

show 20/24 (\$2.00 per page more) sort by relevance/release date/pricerepandant

Product	Price
Dimple Lock Bump Gun	\$97.93
Lock Pick for Focus	\$25.42
Tension Wrenches with Top Mount LED Light and Magnifier (2-Wrench Set)	\$53.42
Lock Pick for Toyota/Lexus Toy 4x	\$26.34

Selling many lockpicking tools

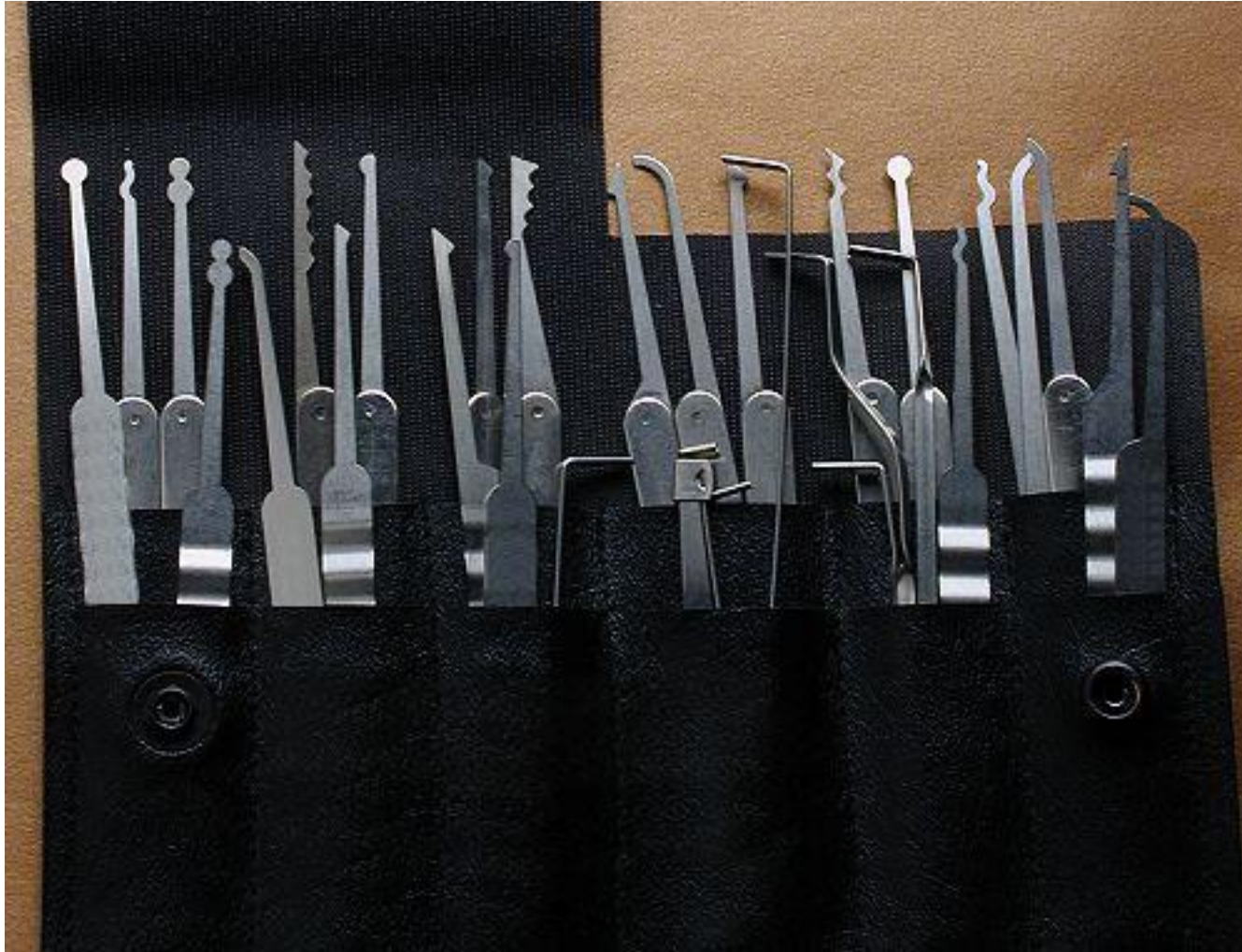

First, let's talk about metal...



Spring Steel



Stainless Steel

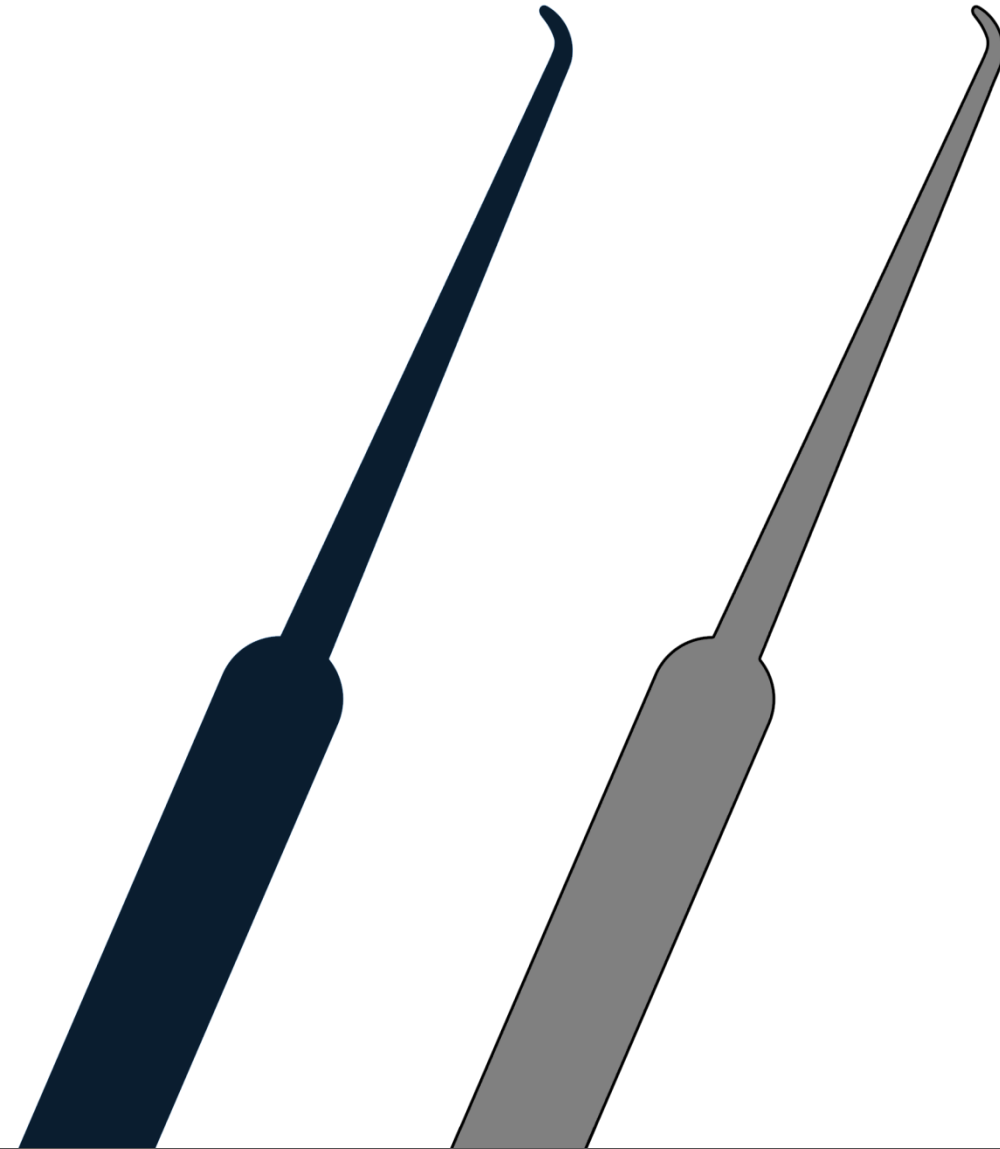

Titanium

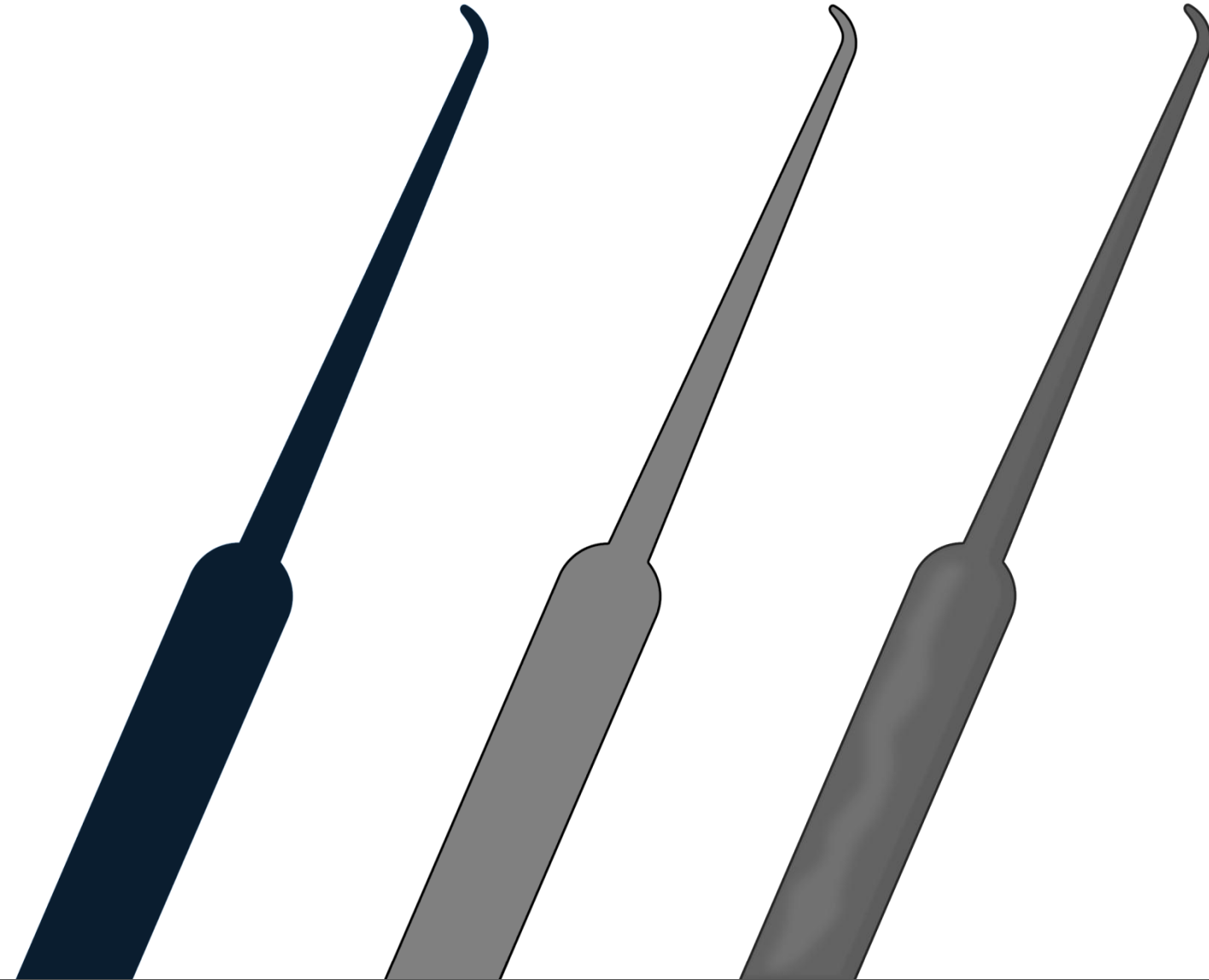

Other Metals?

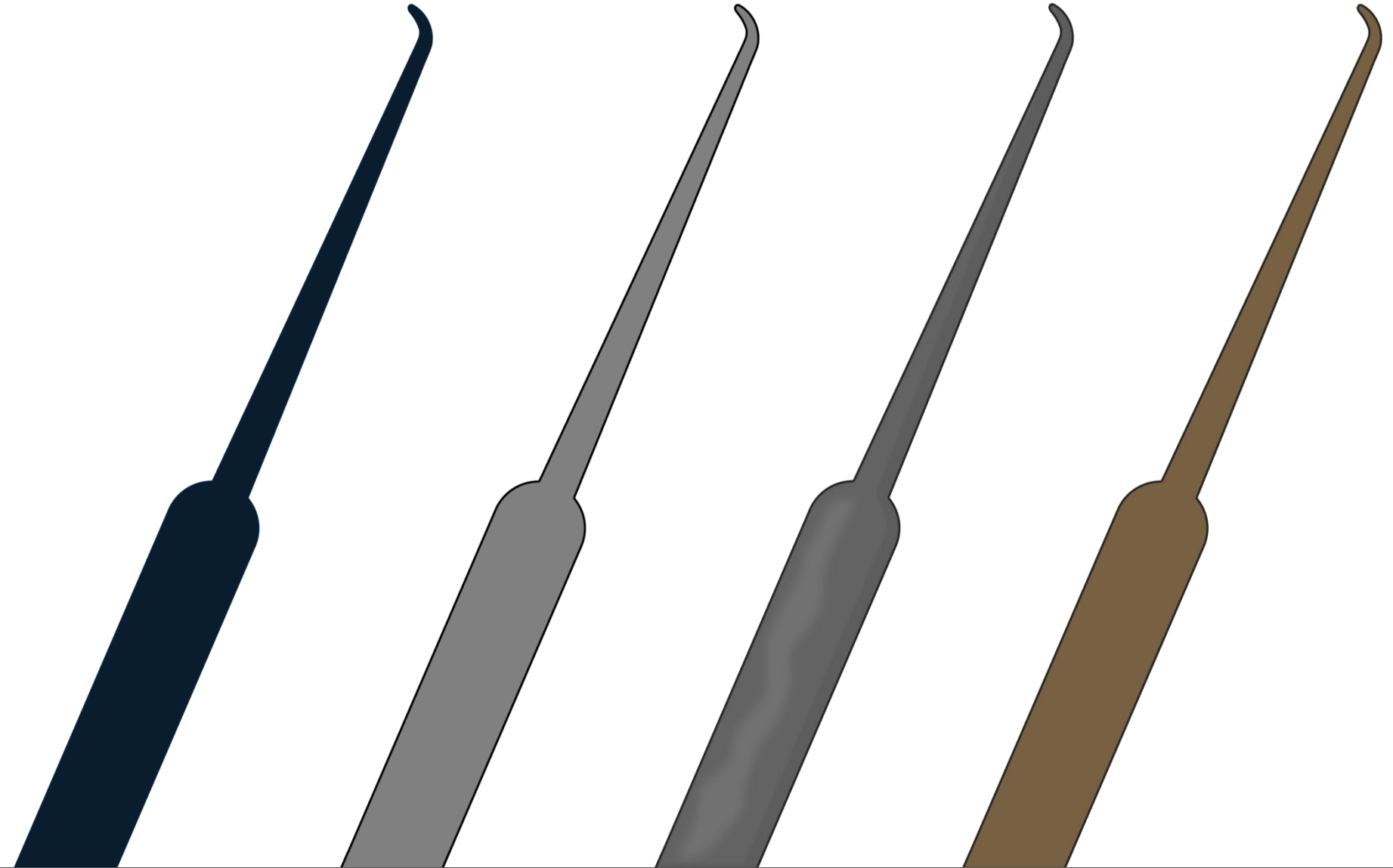

Thickness



0.015" - Peterson
"Government Steel"

0.020" - SouthOrd, Rytan,
Southern Specialties, TOOL

0.022" - HPC Stainless

0.025" - original TOOL kits

0.

<http://to>

"Standard" vs. "Euro"



"Standard" vs. "Euro"

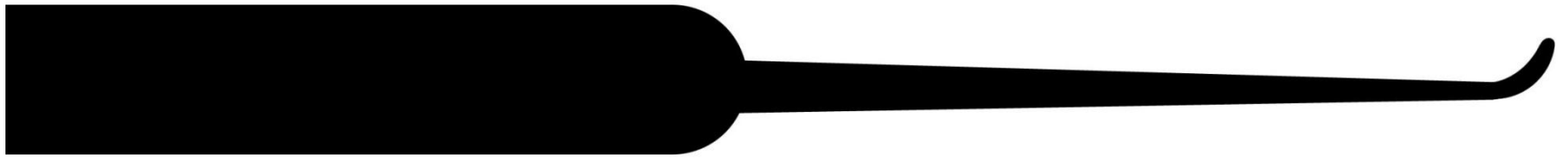
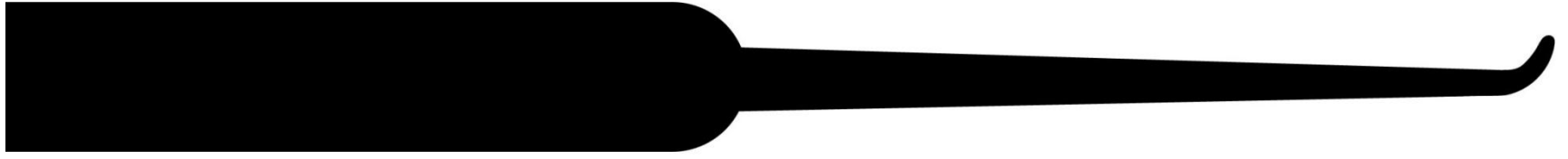

"Standard" vs. "Euro"

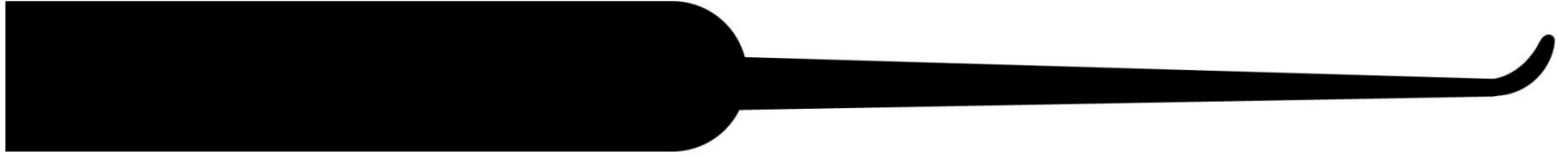
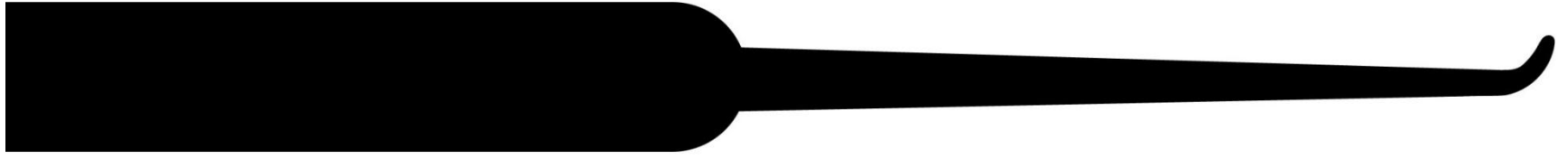

"Standard" vs. "Euro"

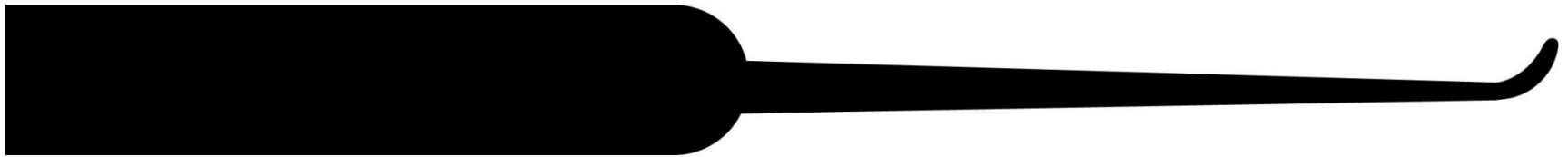
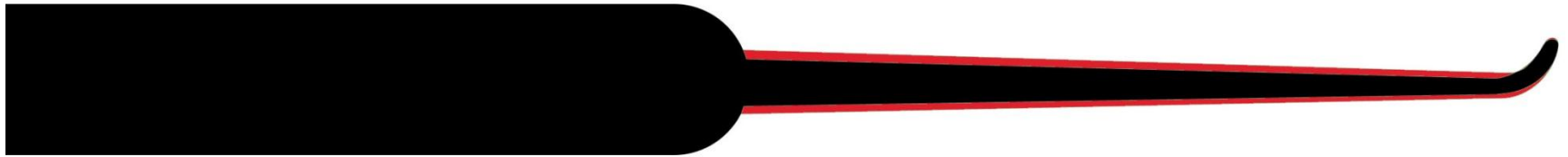
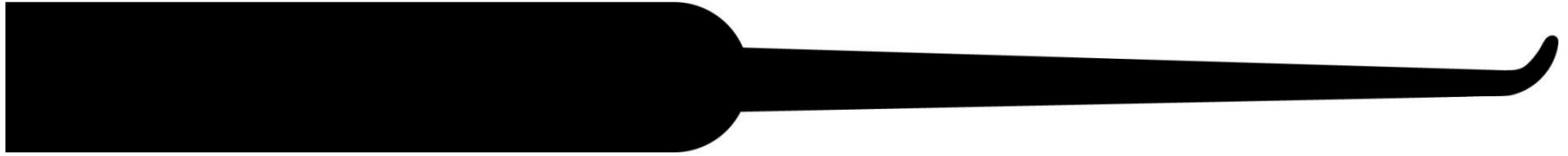

The *real* confusing mess..

Categories & Names

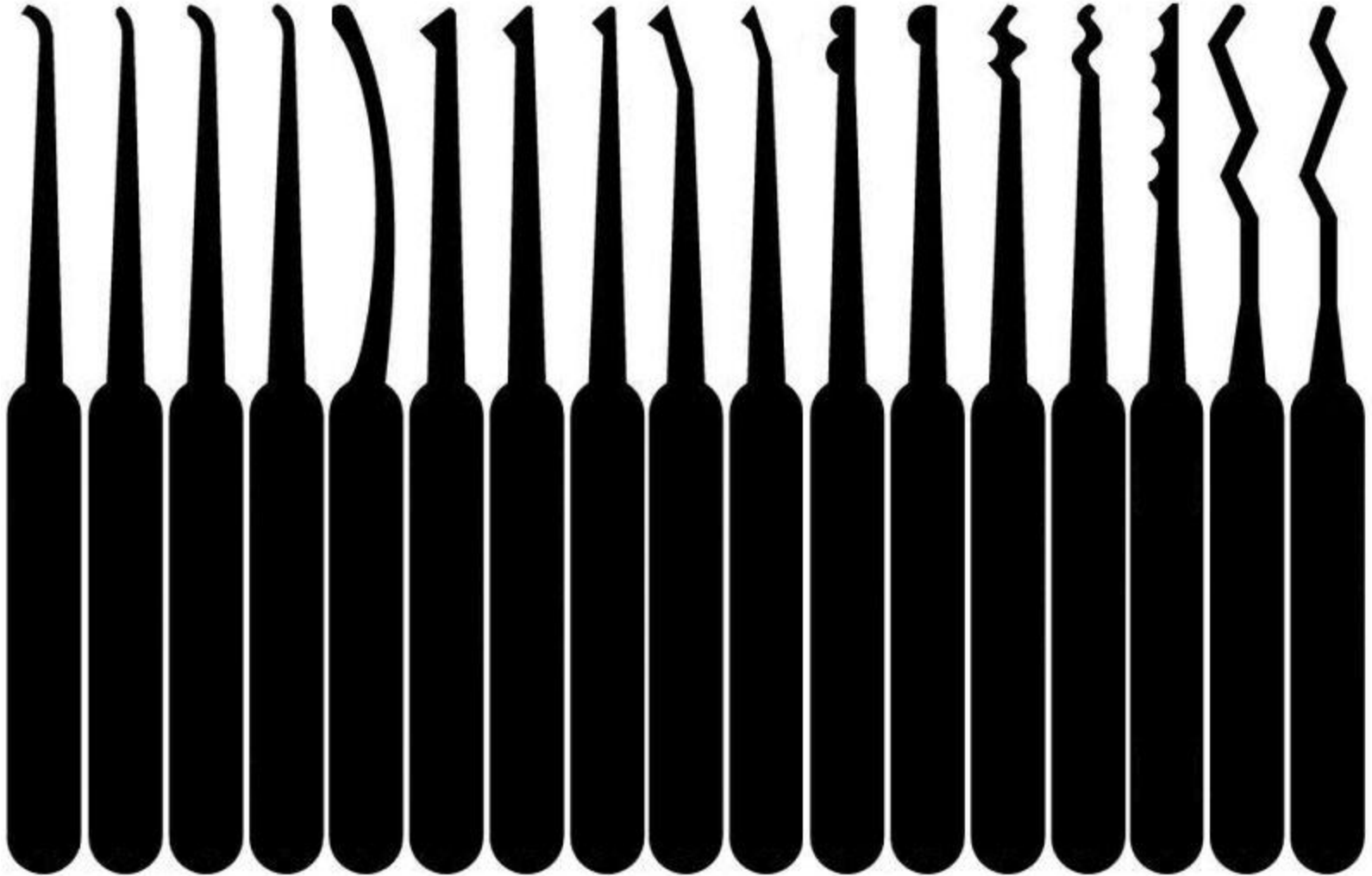

What would you call these?

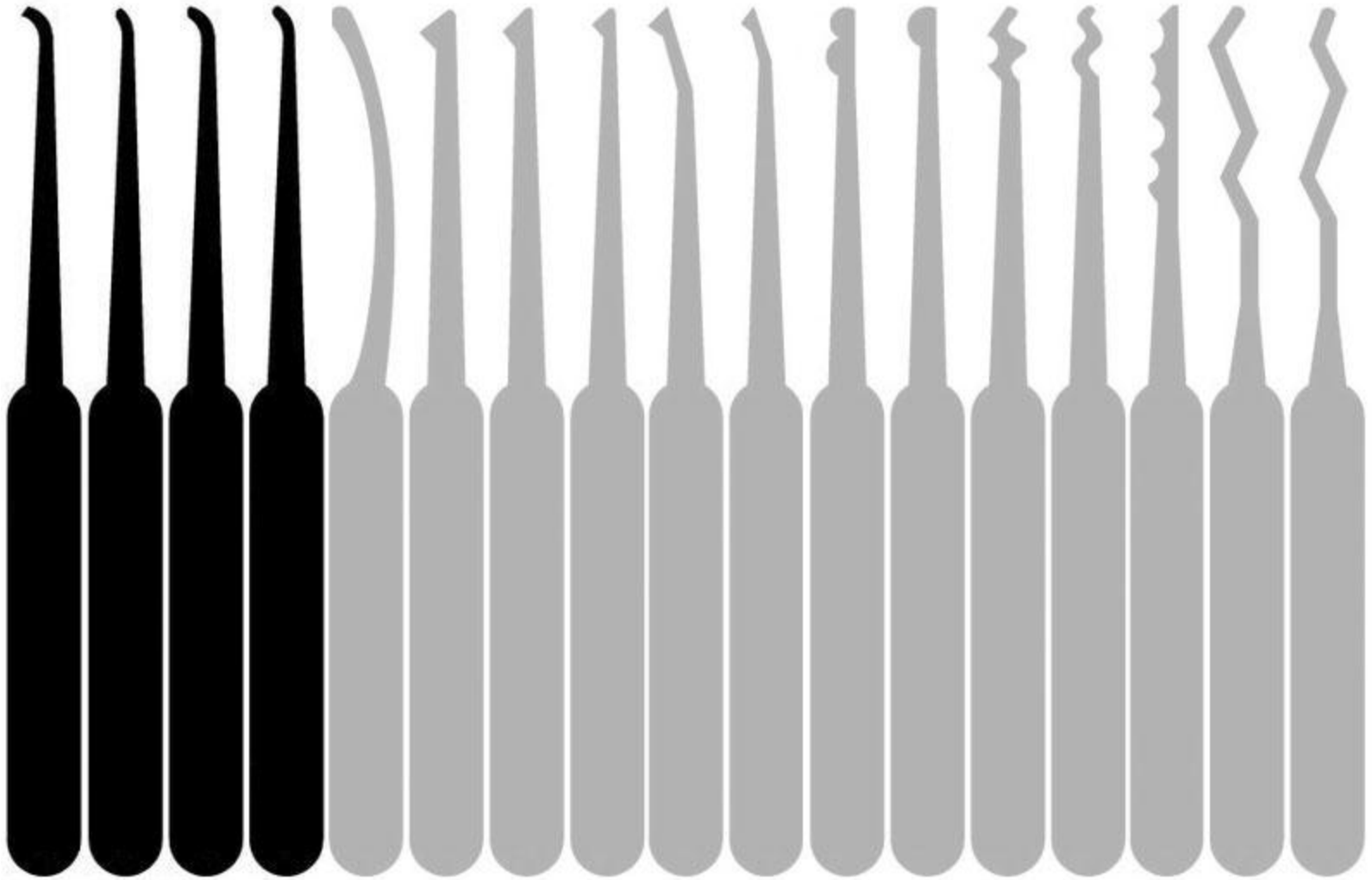

Hooks (a.k.a. Lifters)

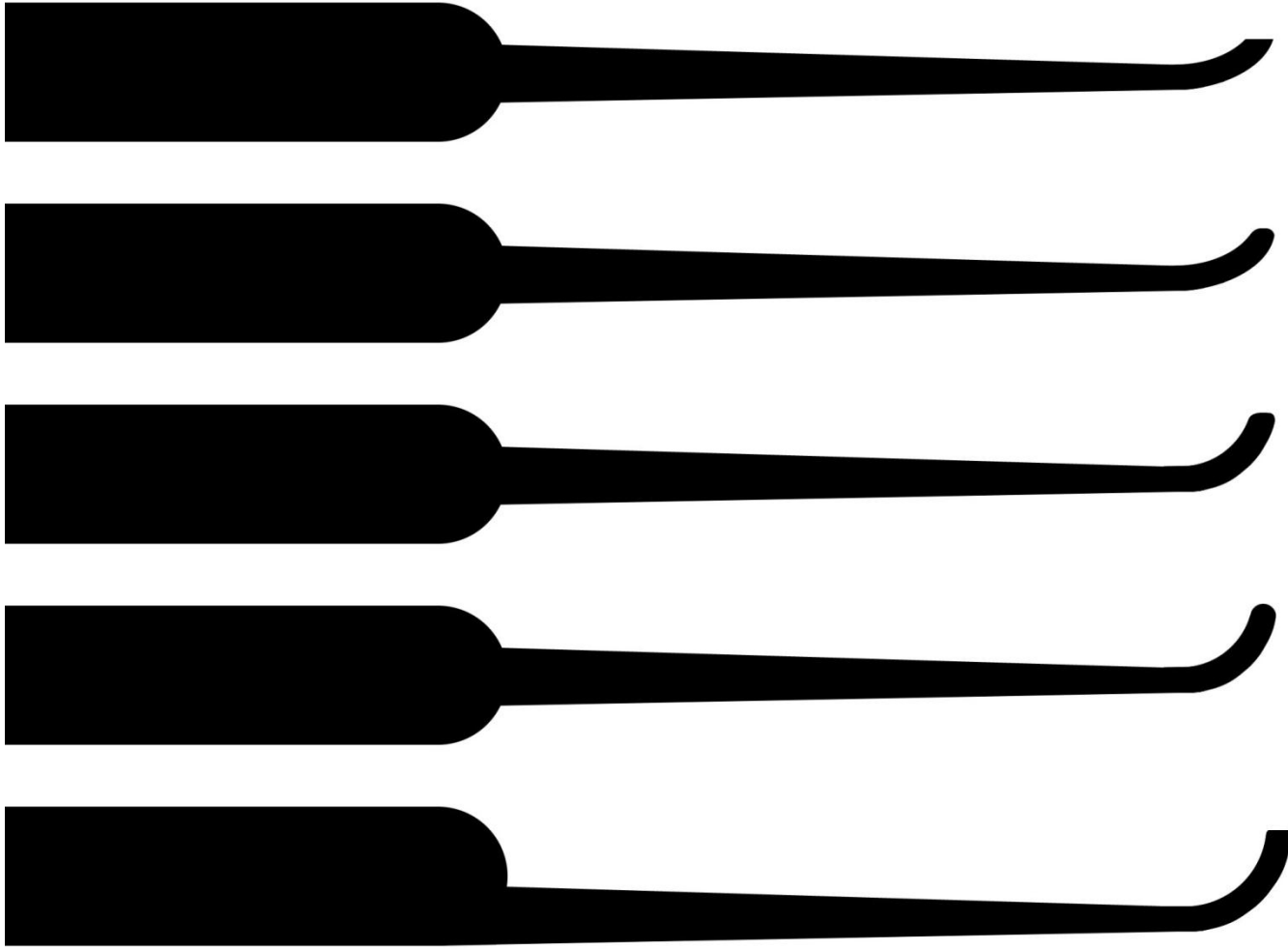

Hooks (a.k.a. Lifters)

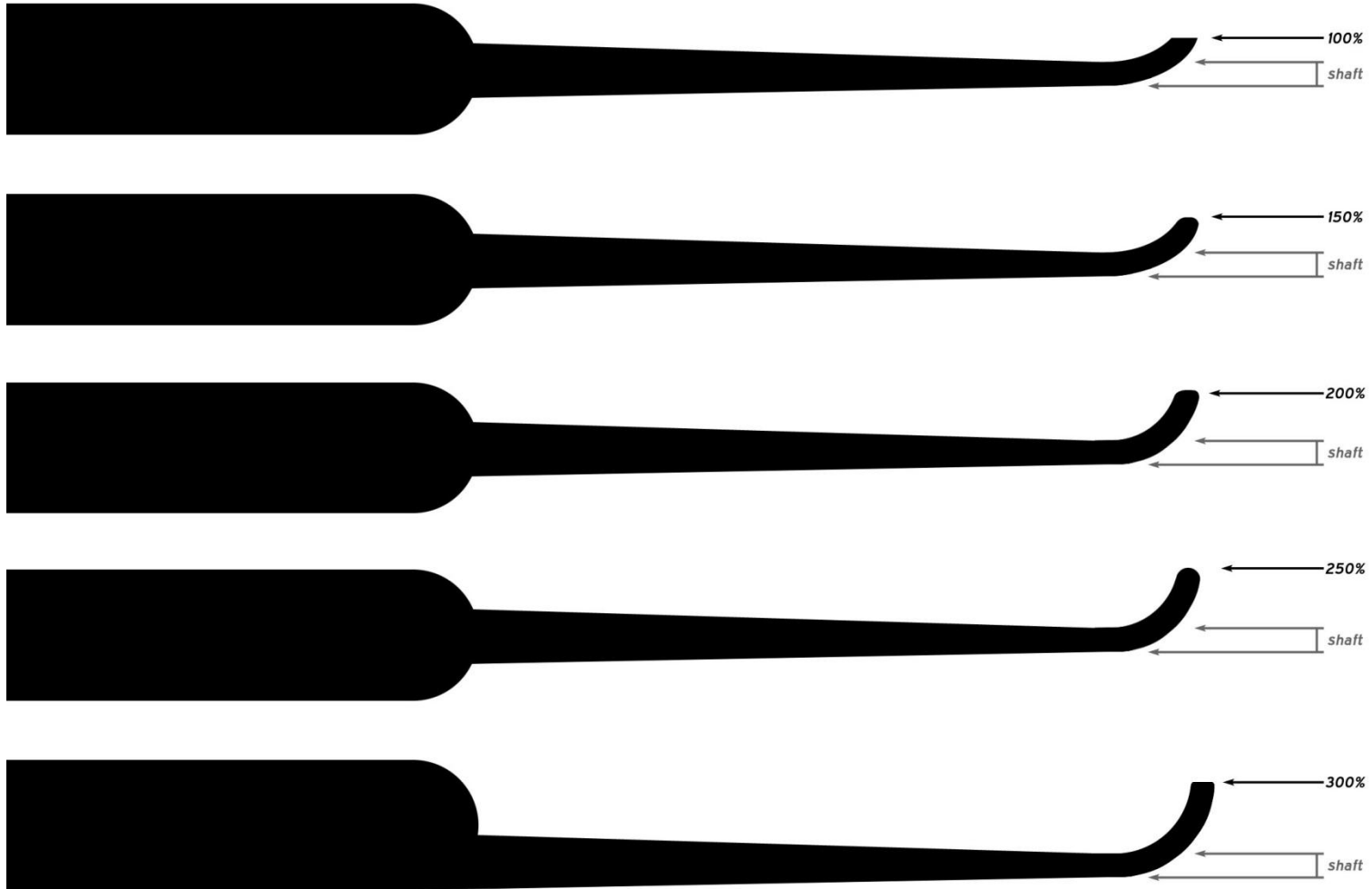

Hooks (a.k.a. Lifters)



Hooks (a.k.a. Lifters)



What would you call these?

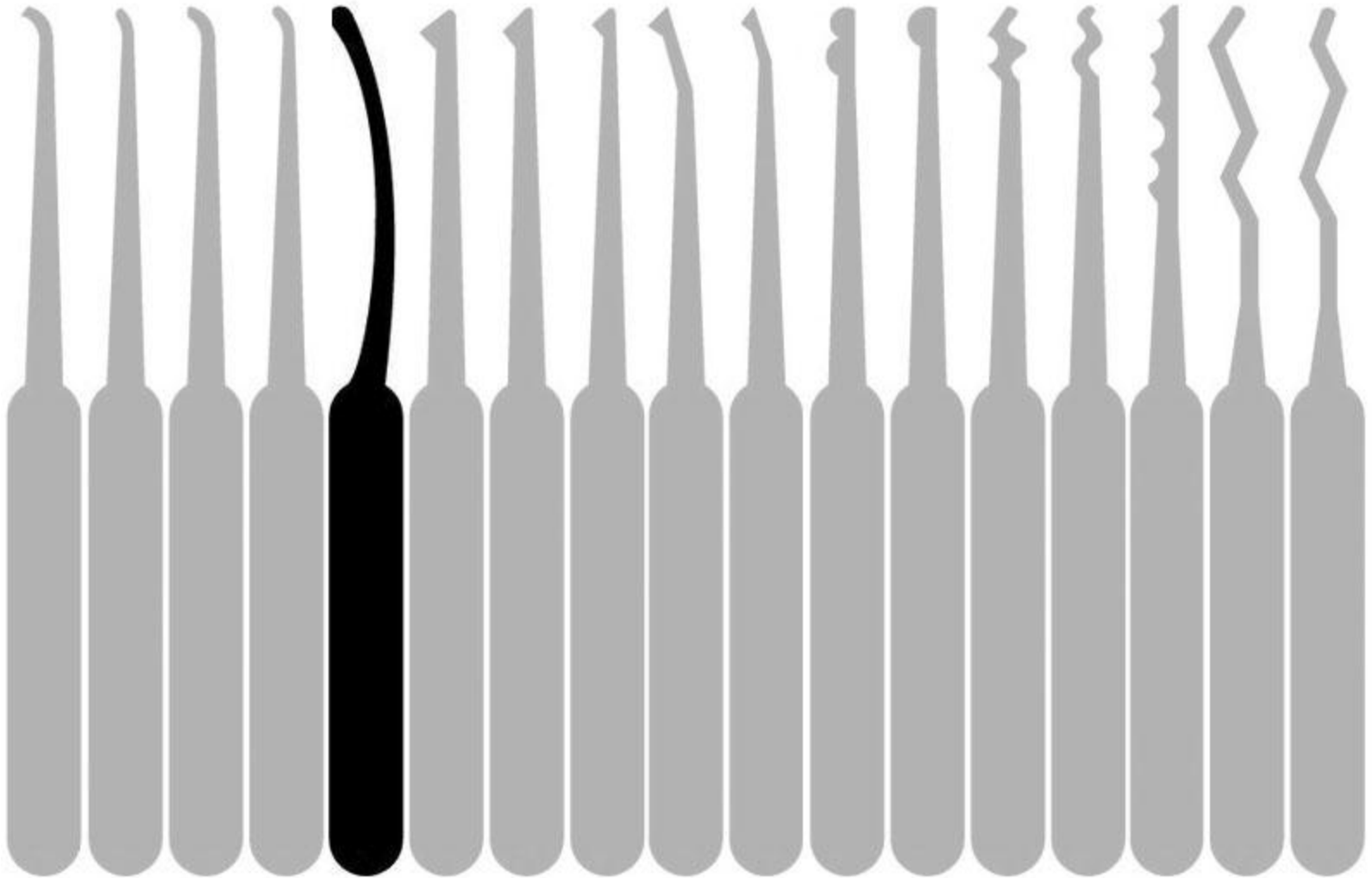

Reach Tools

Deep Curve



Hybrid



You've all seen these...

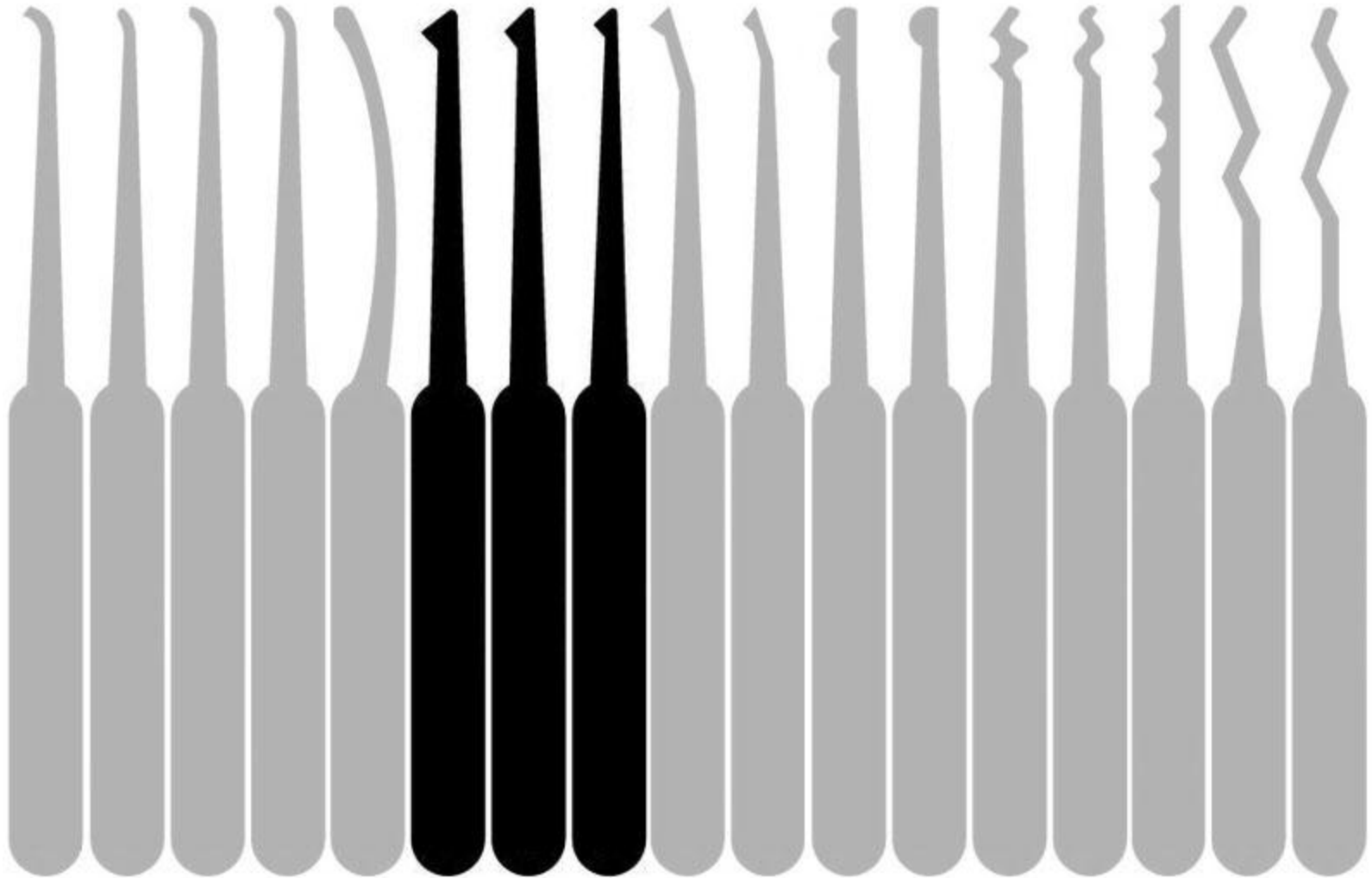

Diamonds

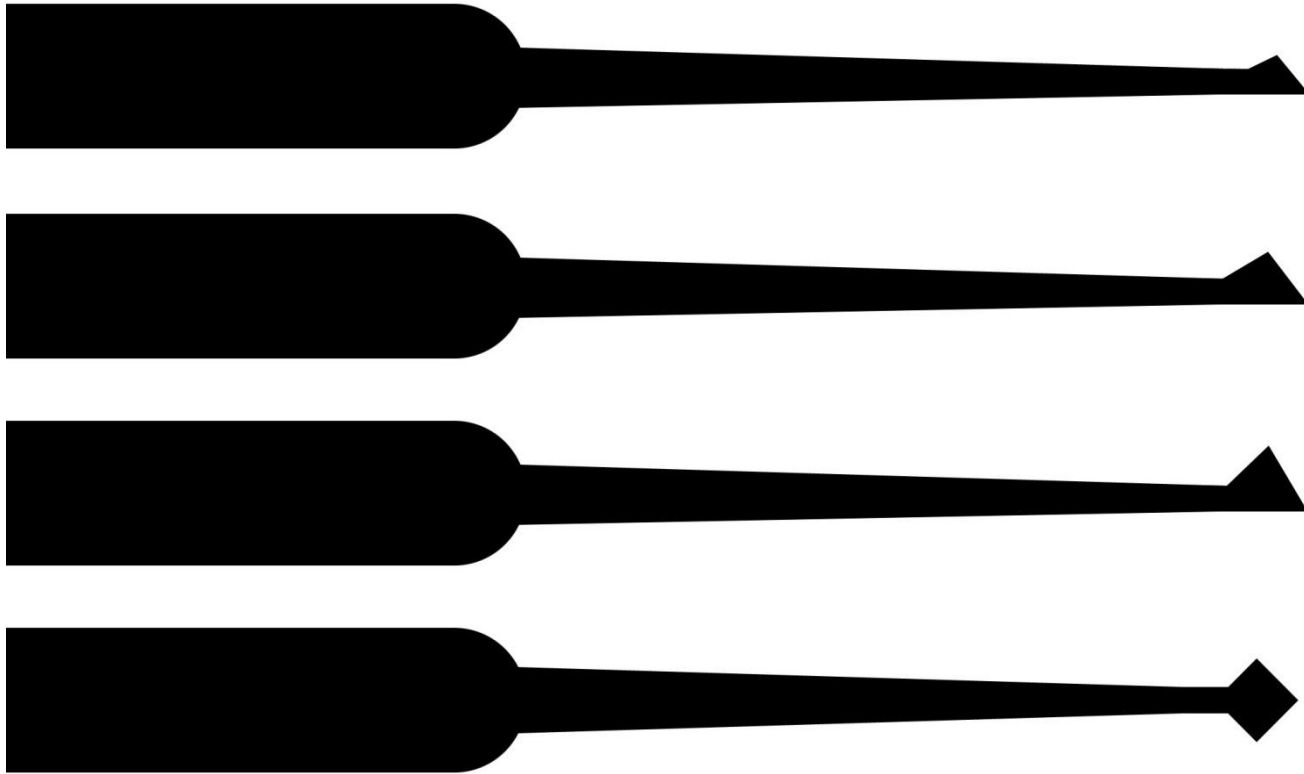

Diamonds

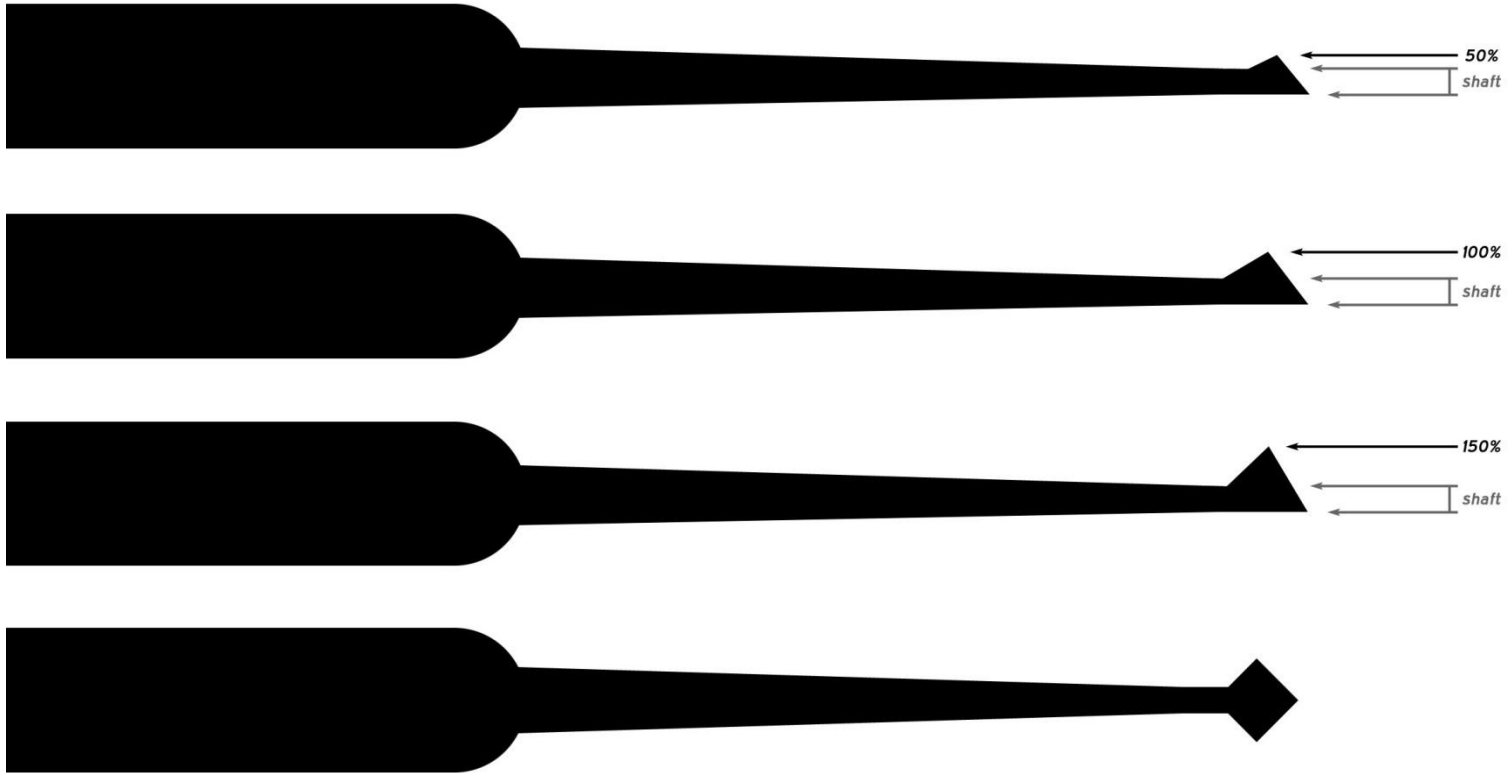

Diamonds

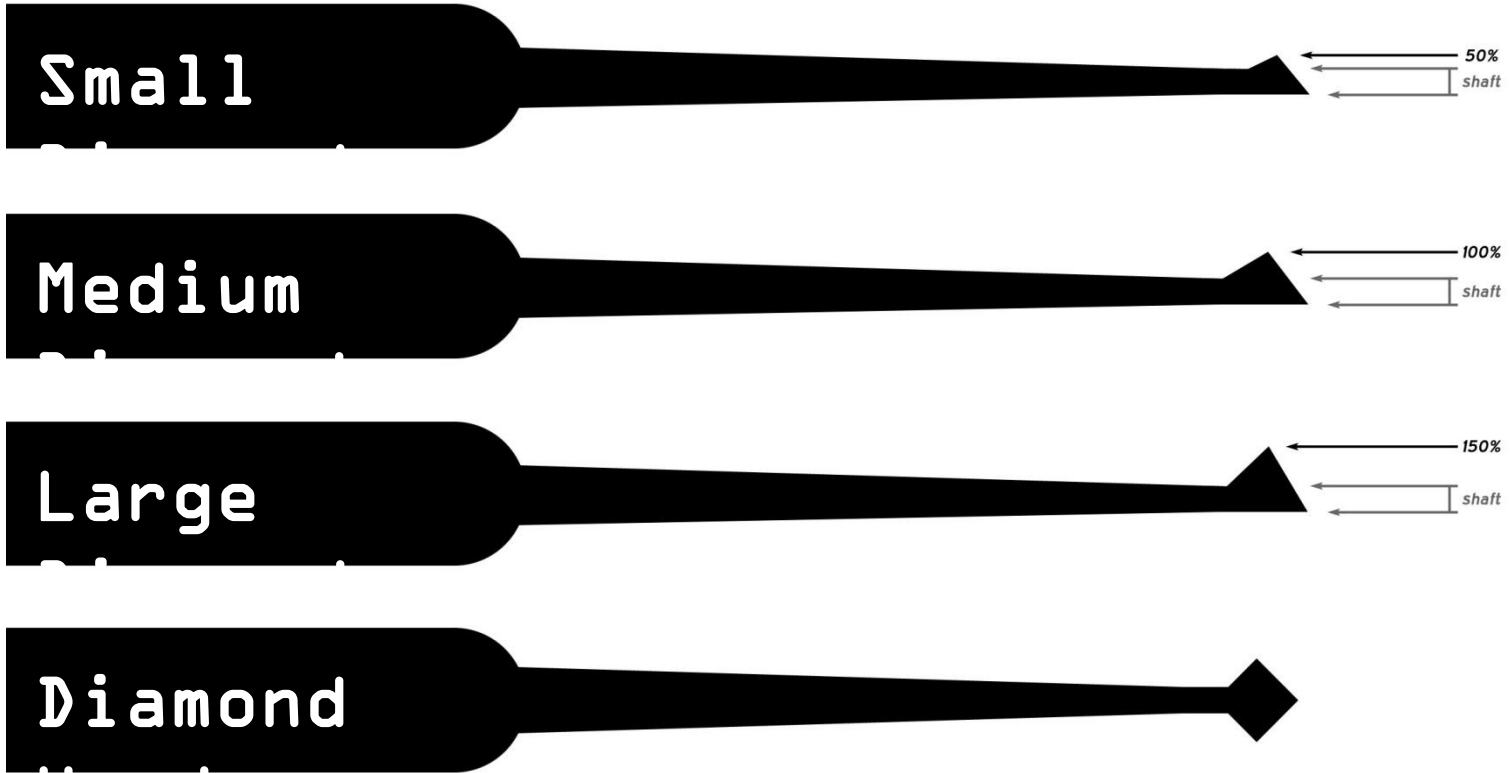

Diamonds

Maybe

50%
shaft

Yes

100%
shaft

No

150%
shaft

Dear God,
Why???

How would you categorize *these*..?

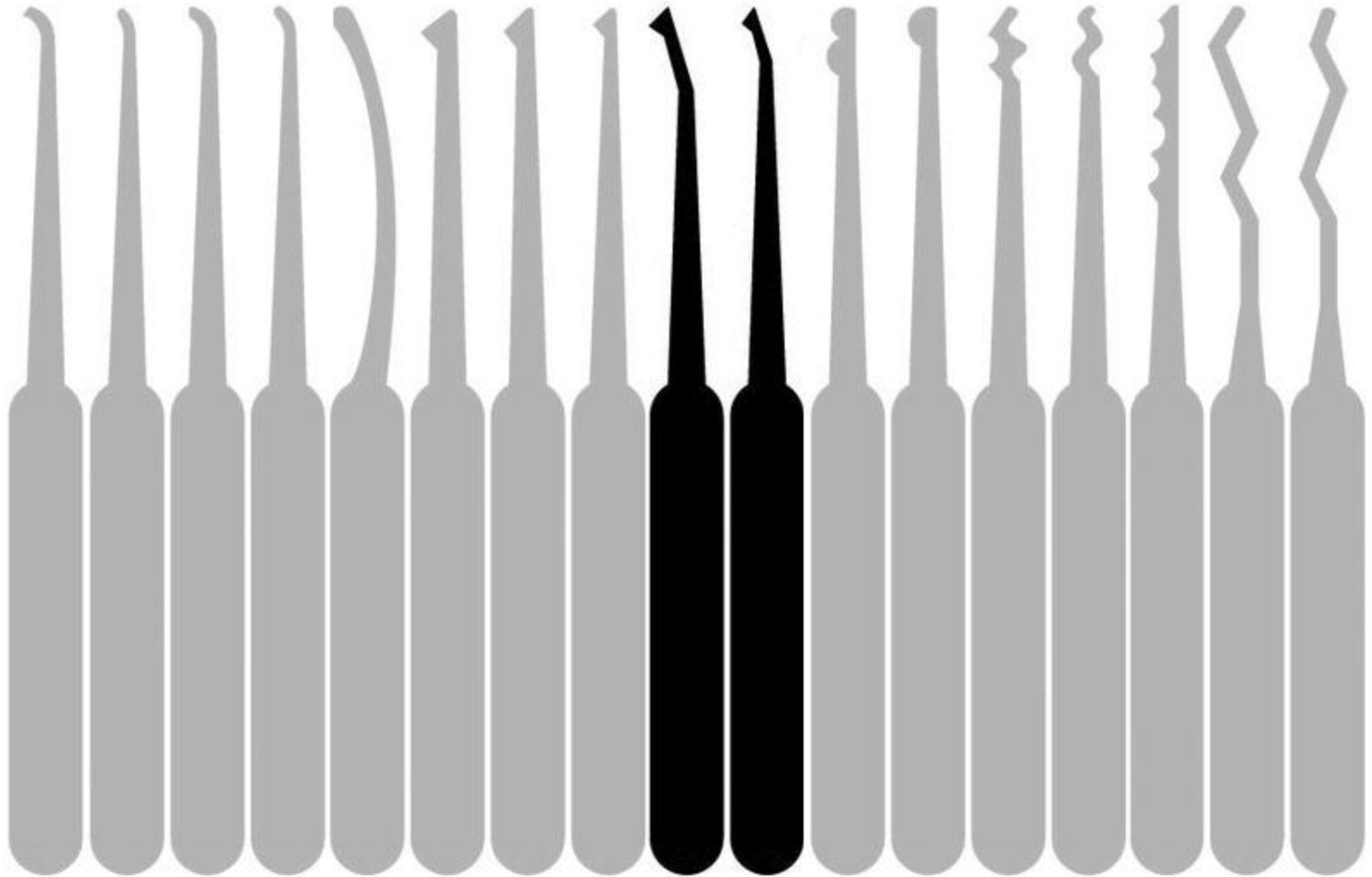

Offset Tools



Offset Tools

Offset

Offset

Offset

Offset Tools

Yeah,
sure.

Meh, why
not?

Really?

Balls, balls, balls...

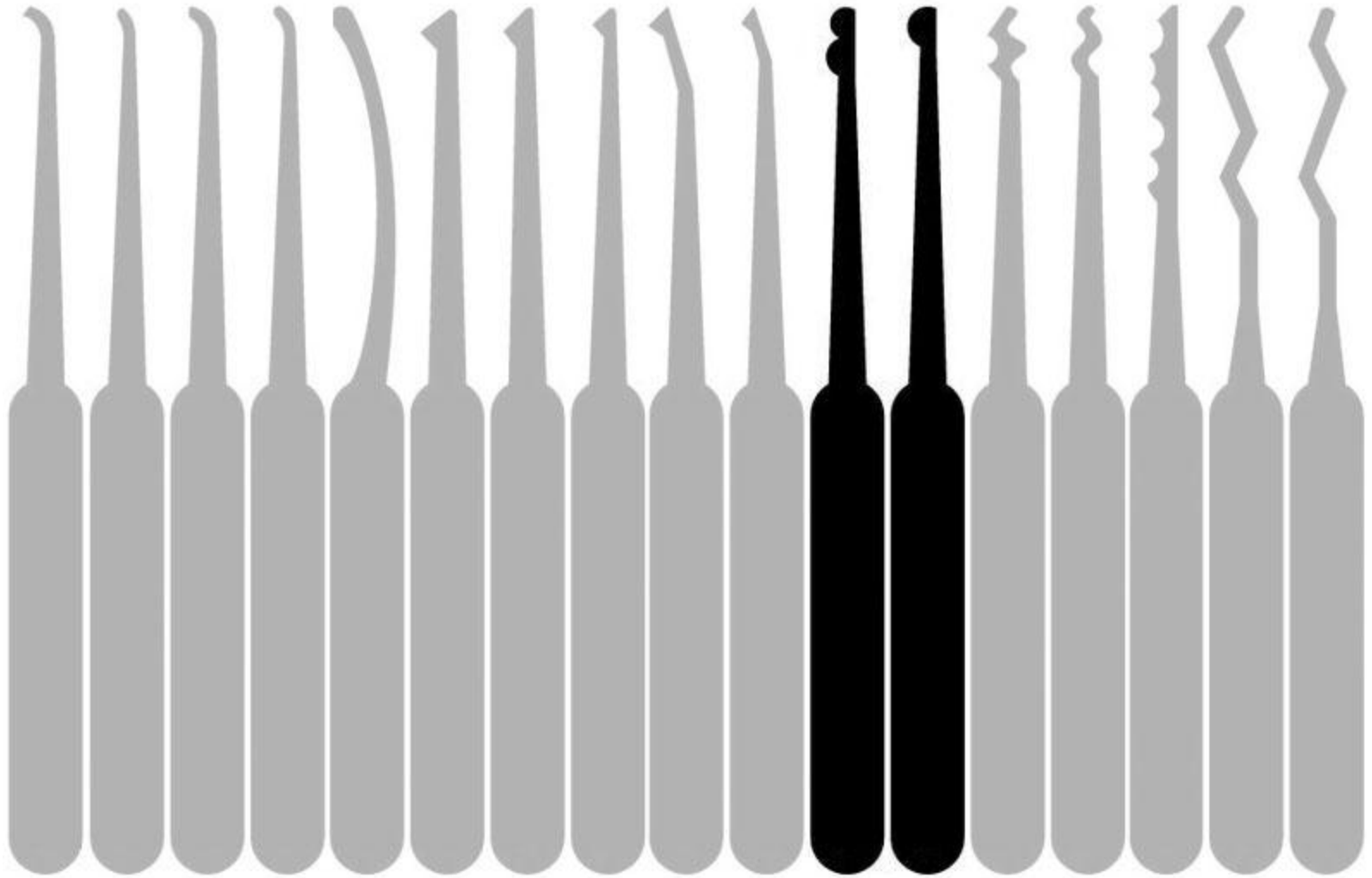

Balls, balls, balls...

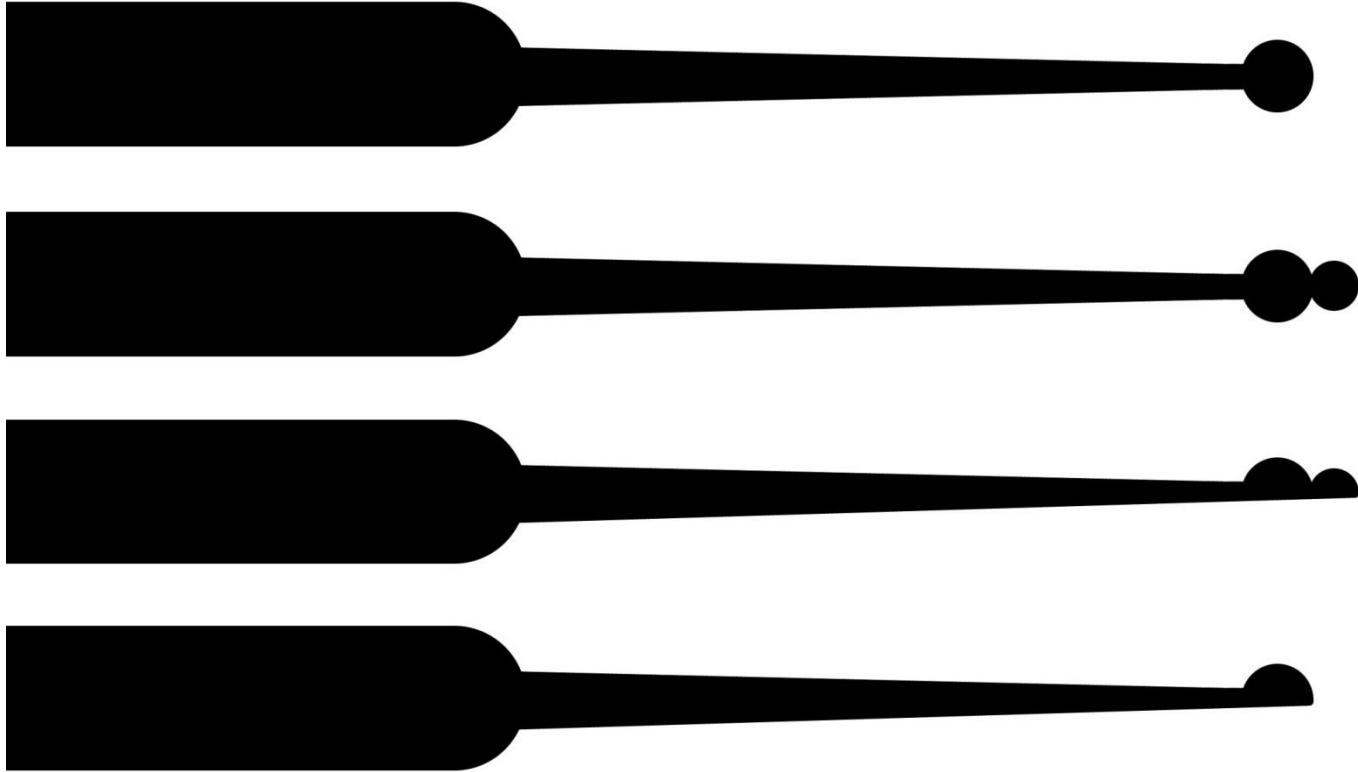

Balls, balls, balls...

Single



Snowman



Half



Half Ball



Balls, balls, balls...

Pretty
Useless

Can Be
Useful

Tight
Spaces?

We Will
Mock You

What would you call these?

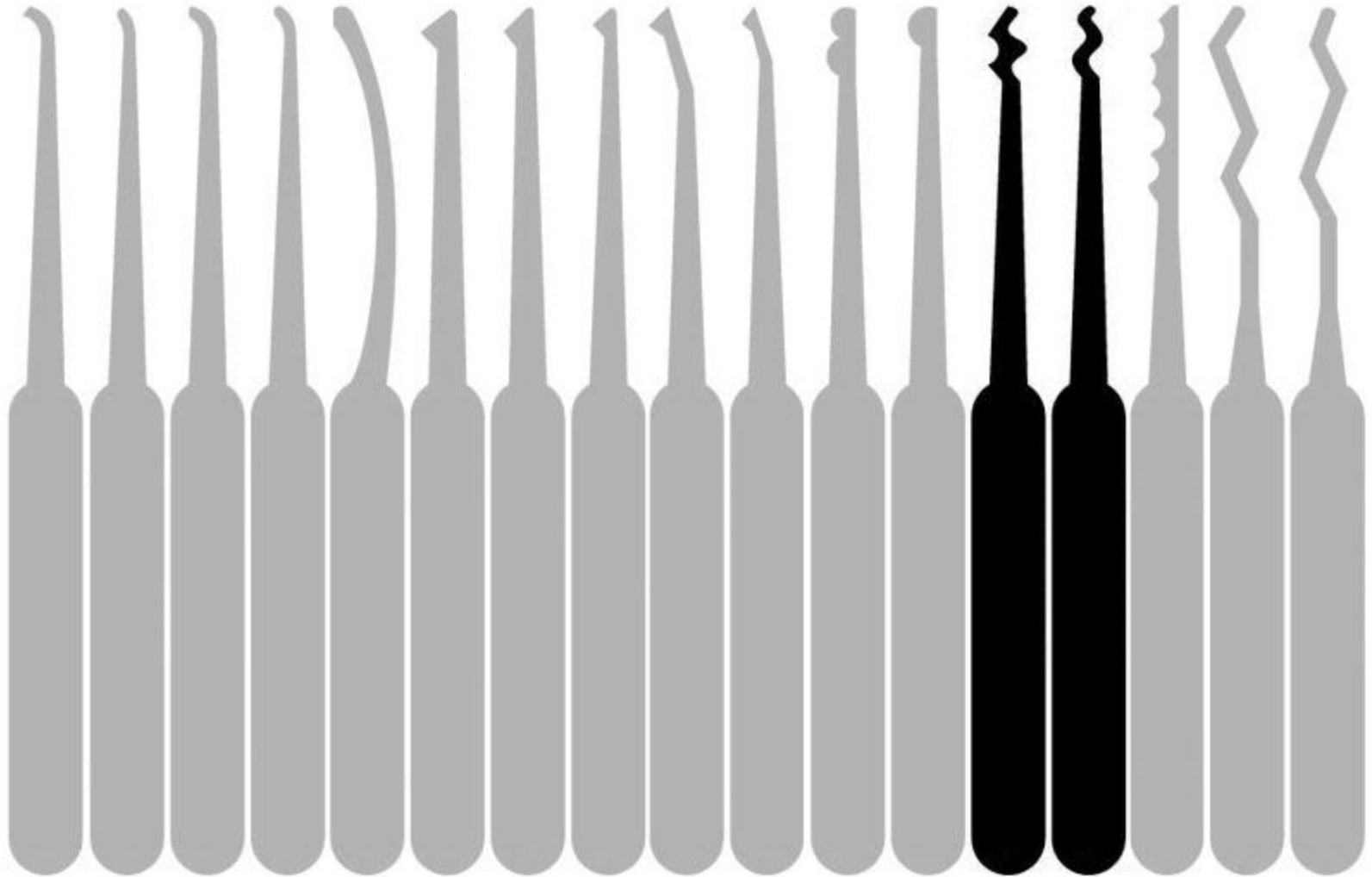

Raking tools... Welcome to Crazy Land



Raking Tools

Snake



a.k.a. C Rake,
Double Rake

Three Quarter
Snake



a.k.a. Rake-and-
a-Half

Half Snake



a.k.a. Single
Rake

Double Snake



a.k.a. Quad
Rake

Stretched
Snake



a.k.a. S Rake

Batarang



a.k.a. S Rake,
Camel Back

Raking Tools

Snake



a.k.a. C Rake,
Double Rake

Three Quarter
Snake



a.k.a. Rake-and-
a-Half

Half Snake



a.k.a. Single
Rake

Double Snake



a.k.a. Quad
Rake

Stretched
Snake



a.k.a. S Rake

Batarang



a.k.a. S Rake,
Camel Back

*Dangerous
Weakness*



What about something like *this*..

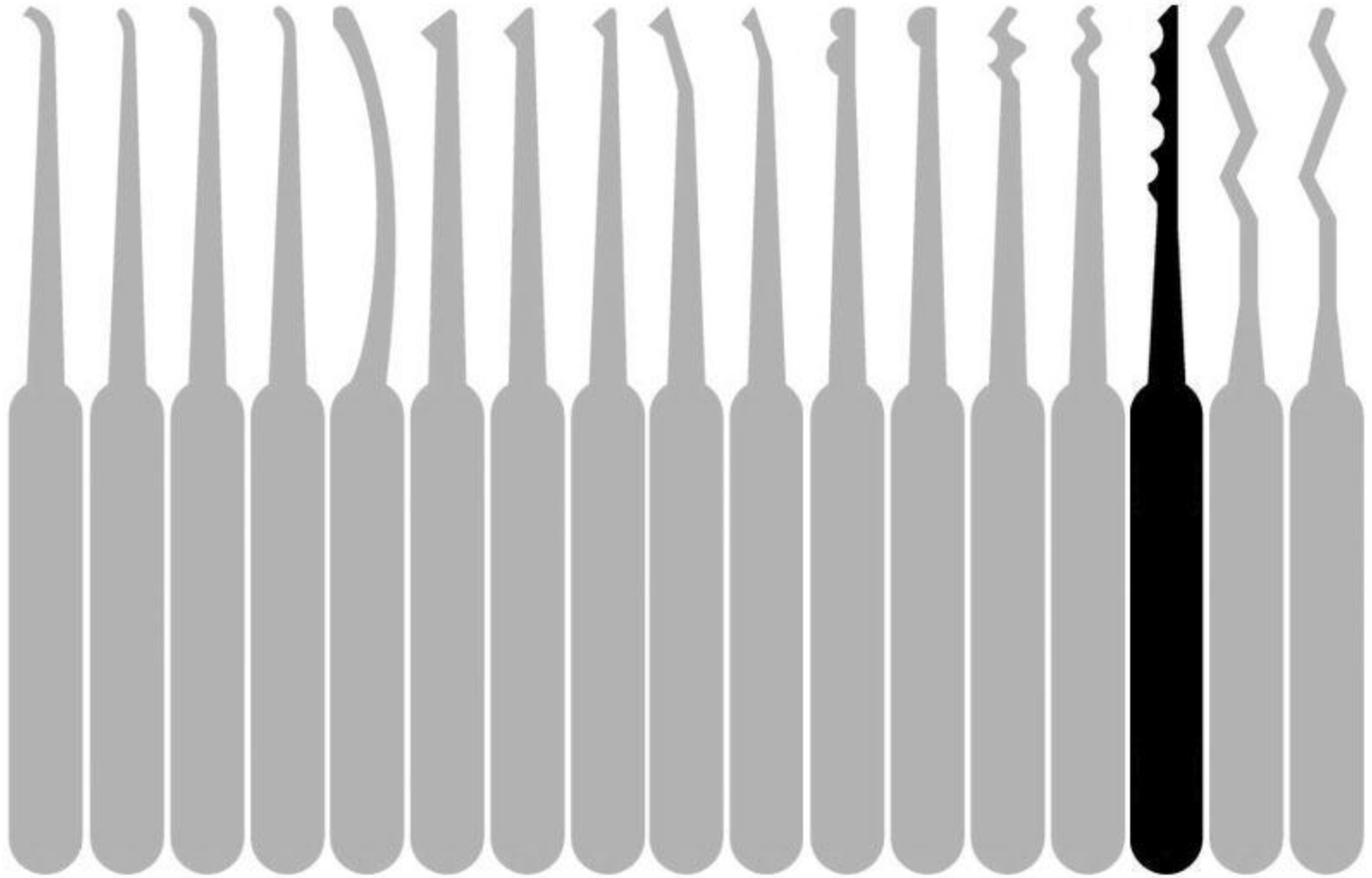

"Raking" vs. "Lifting"



Raking

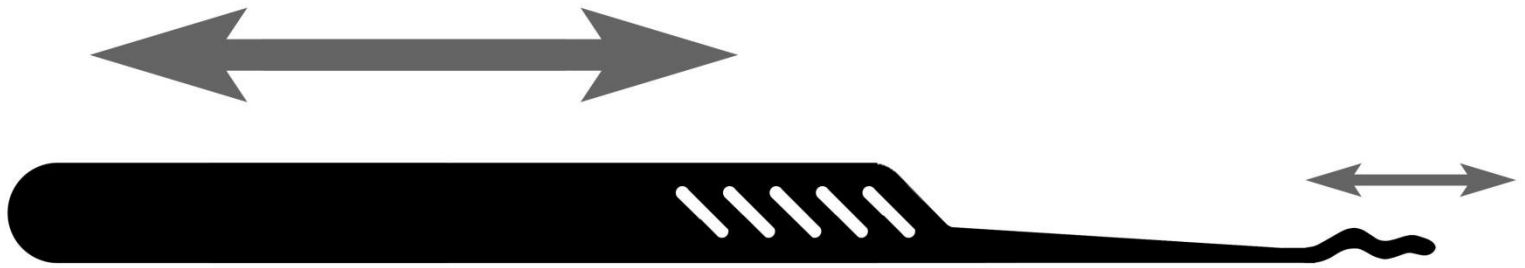

Raking

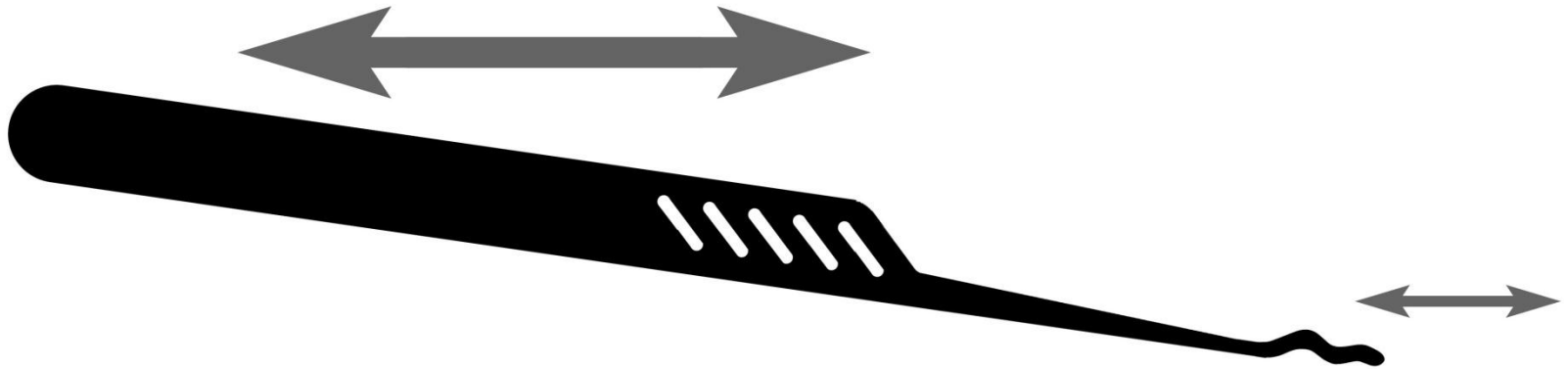

Lifting

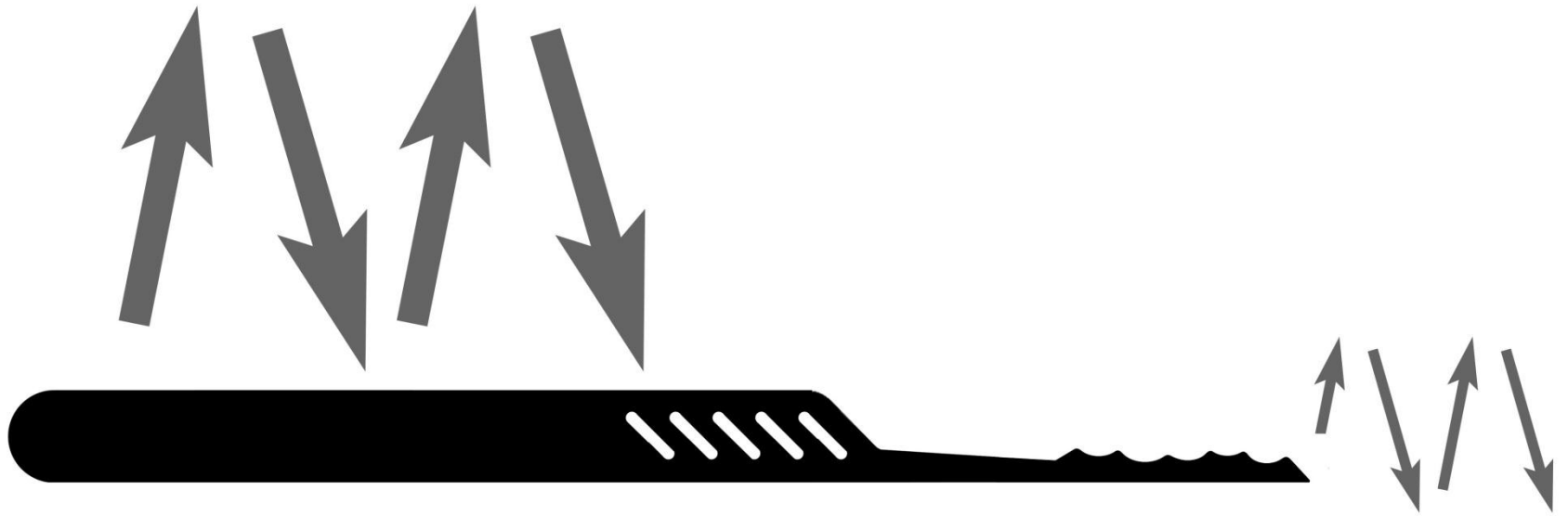

Jagged Lifters

Wedge



a.k.a. W Rake,
Short Jag,

Long Rake



Ramped Tool, &
a.k.a. L Rake,
Long Jag,

Falle



Ripple, & Saw
Tooth

Falle



Falle Hump



a.k.a. Long
Rimple

So, what on earth are *these*?

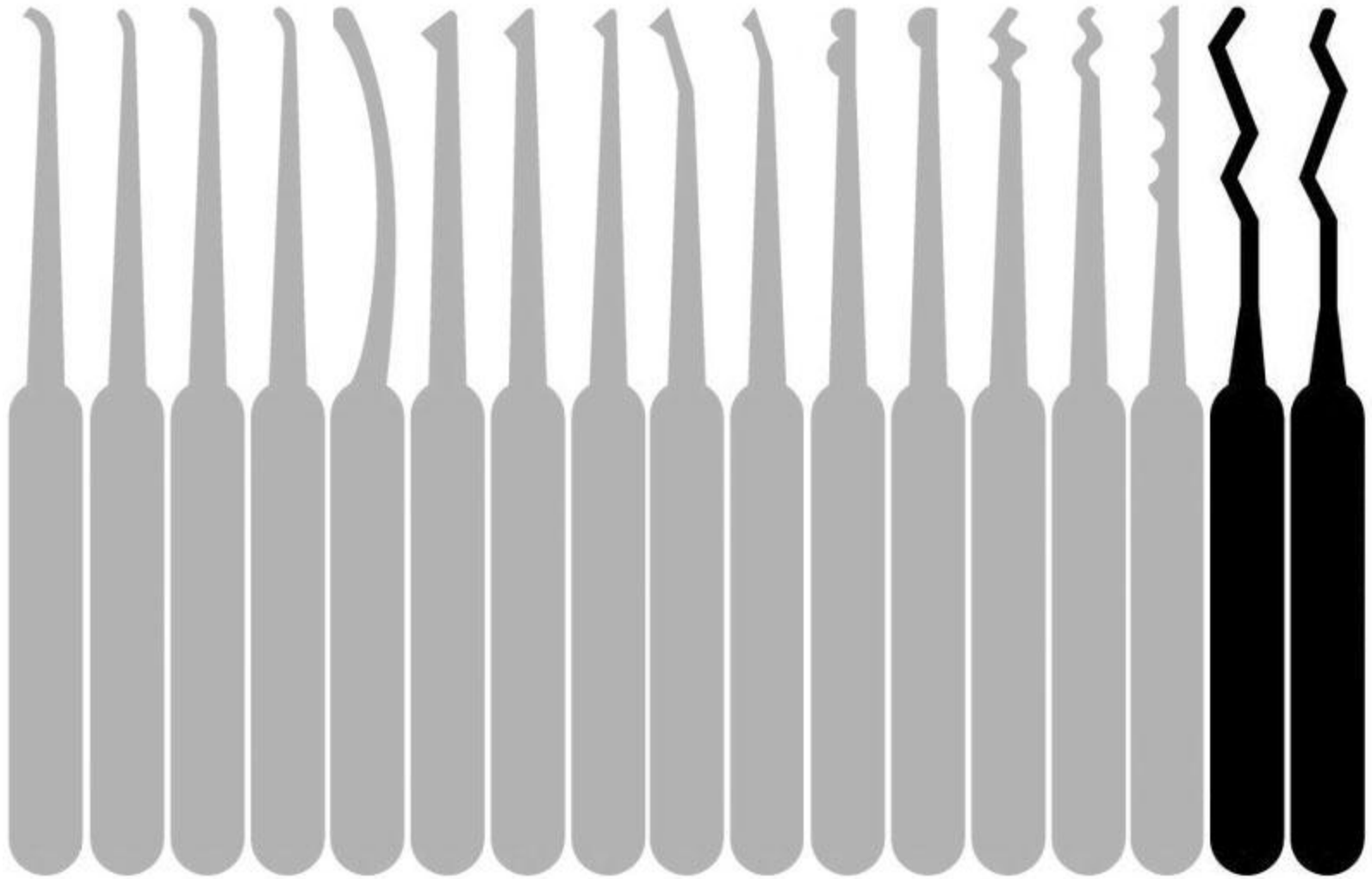

King & Queen

King Pick



Queen Pick



A major innovation in pick tools

Thanks to Minnesota...



... with a nod to Colombia

Raimundo's Family of Tools



It Started with Two Tools..



"Jiggler"
Tools

What is Jiggling?

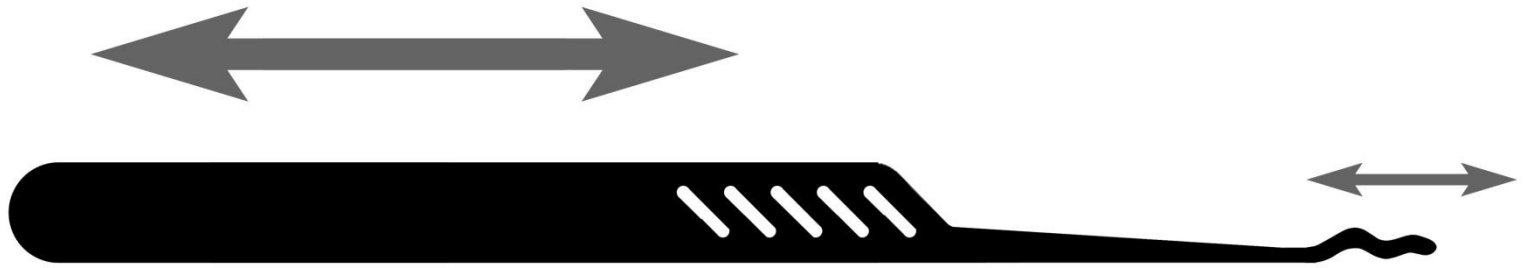

In Between Raking & Lifting ..

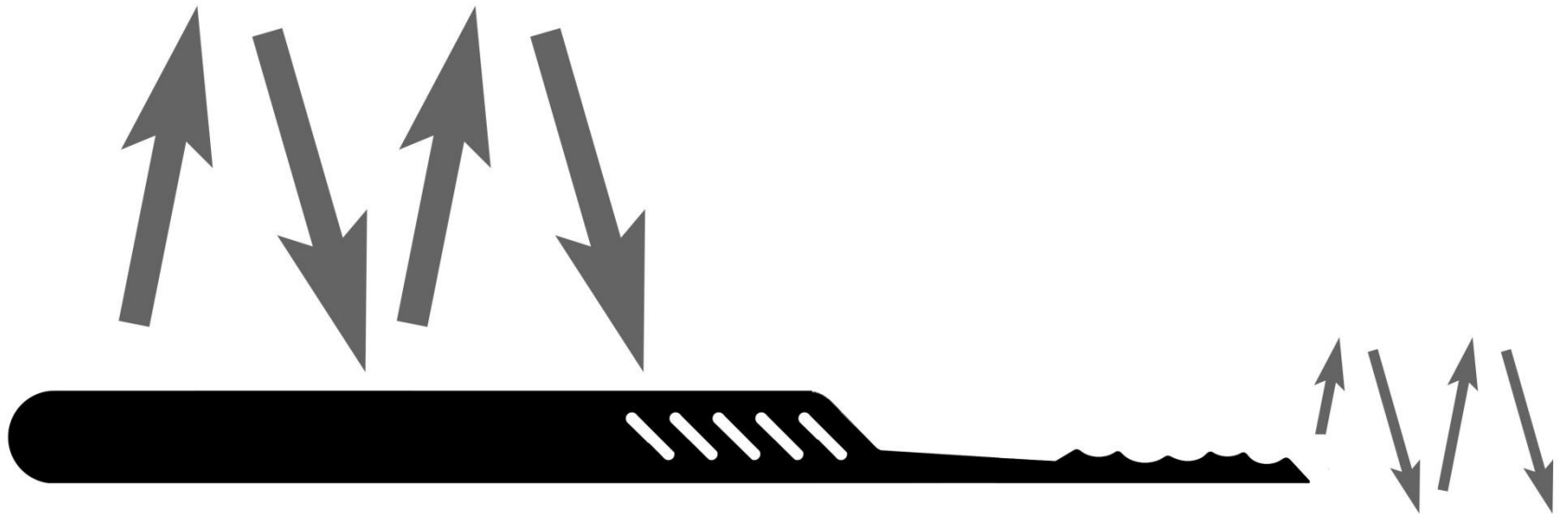

What is Jiggling?

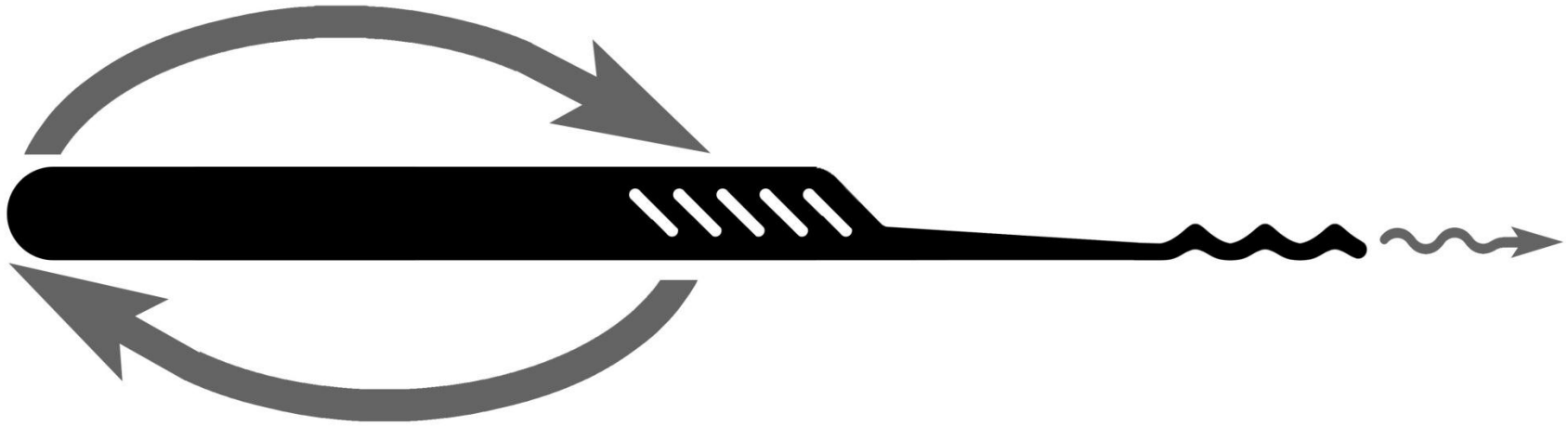

... There is "Jiggling"

Bogóta Family



Bogóta



Single Hump a.k.a.

Hollow Half Diamond

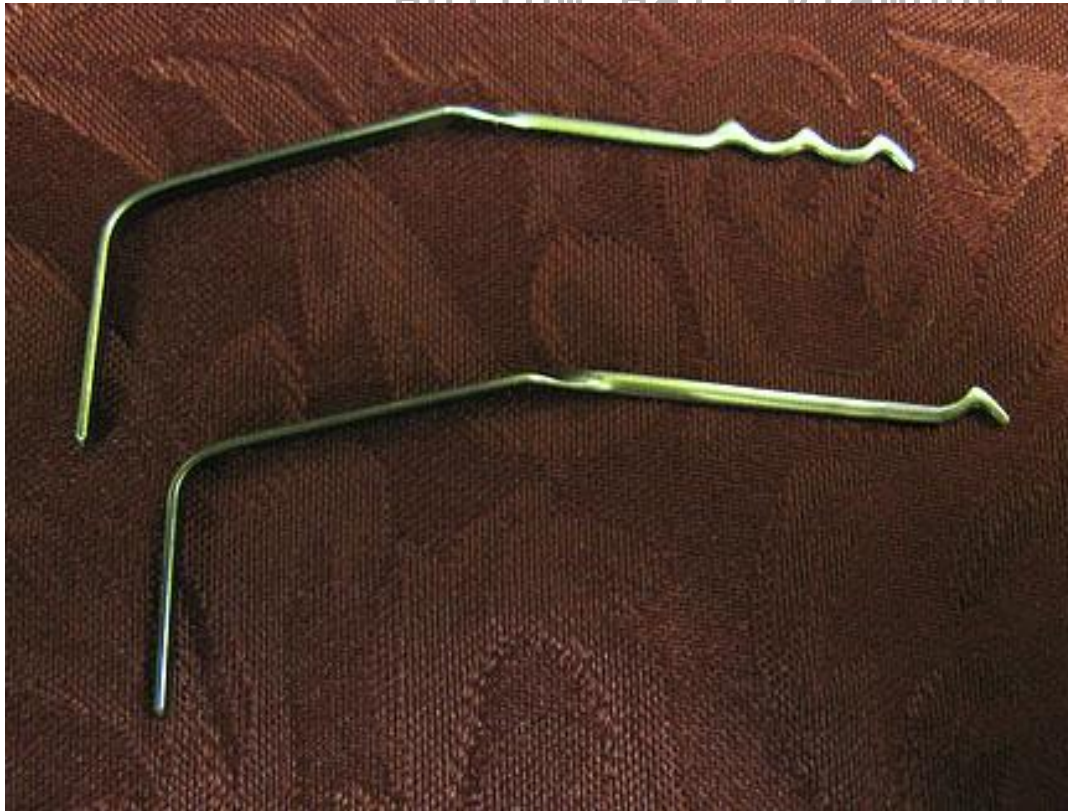

Bogota Family



Bogota



Single Hump a.k.a.

Hollow Half Diamond



Two Hump

a.k.a. Camel



Quad Hump



Sabana

<http://theamazingking.com/bogota.html>

Questions?

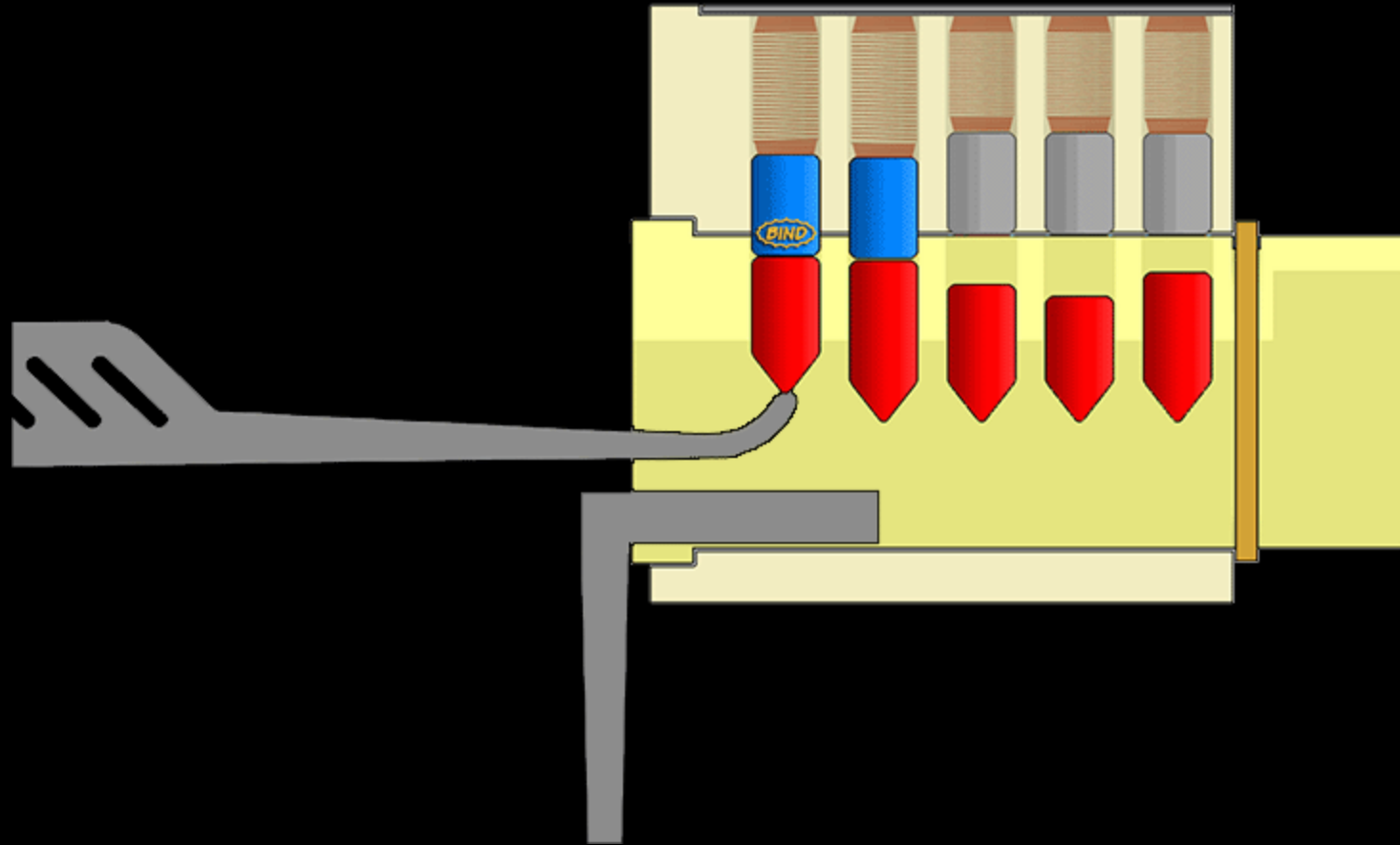

Lockpicking & Forensics

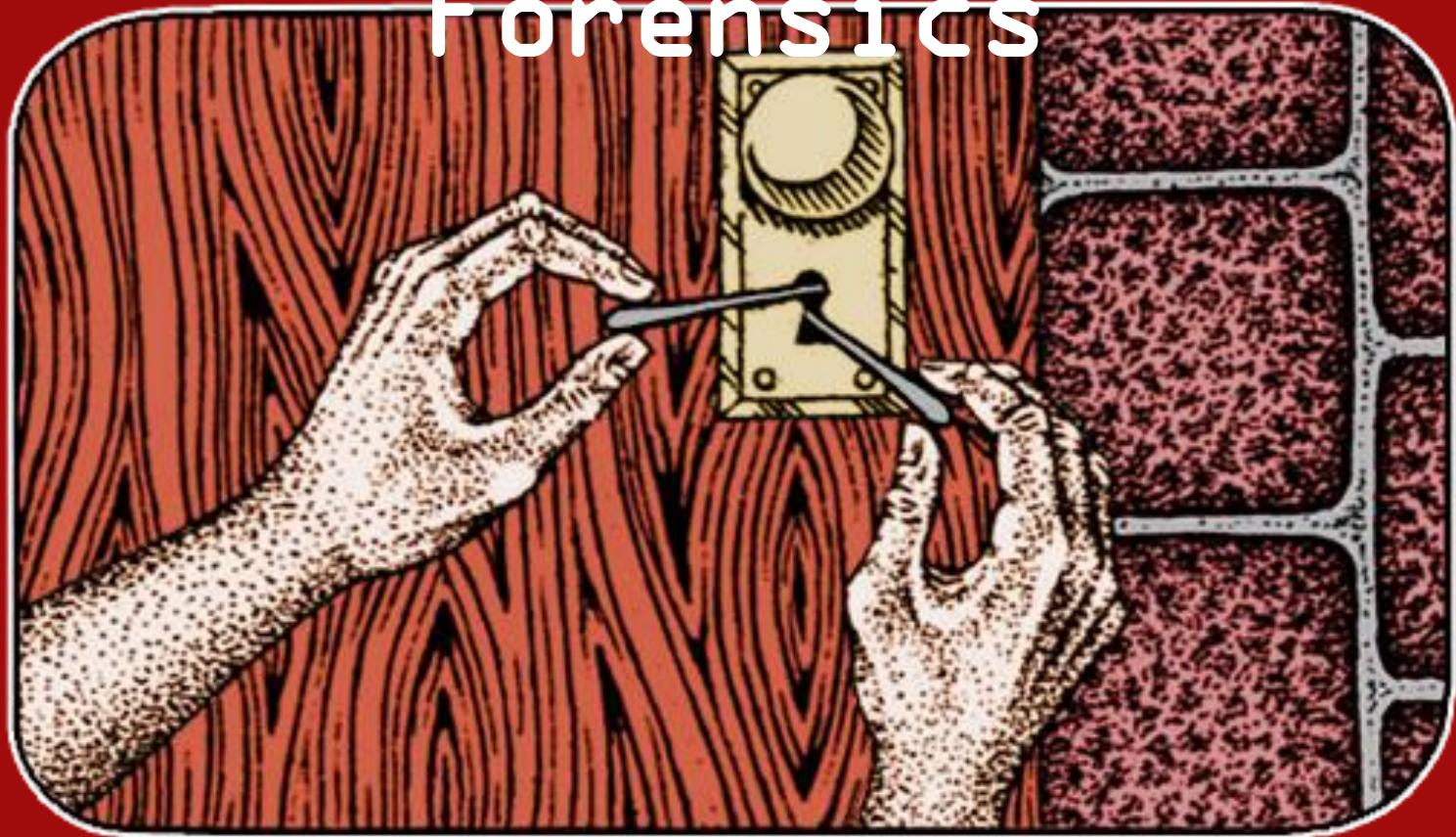

Keys Touch Very Specific Places

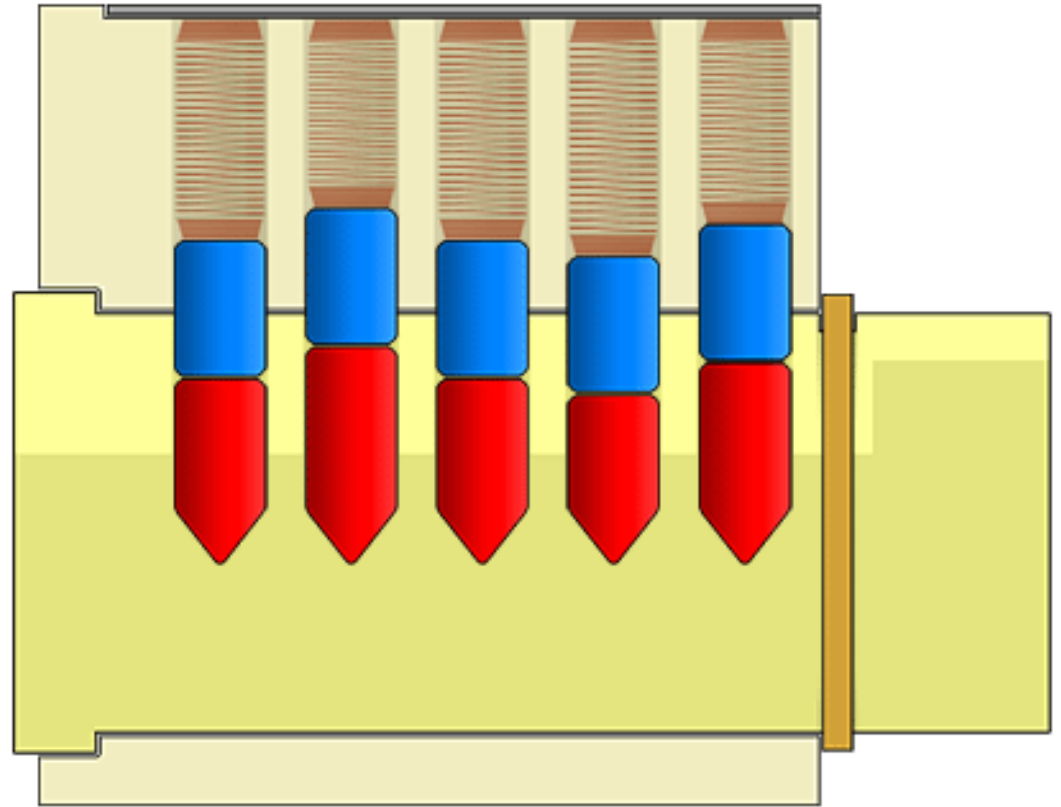

Virgin Pins Have Specific Patterns From Manufacturing



Concentric Tiny Ridges on Pin Face

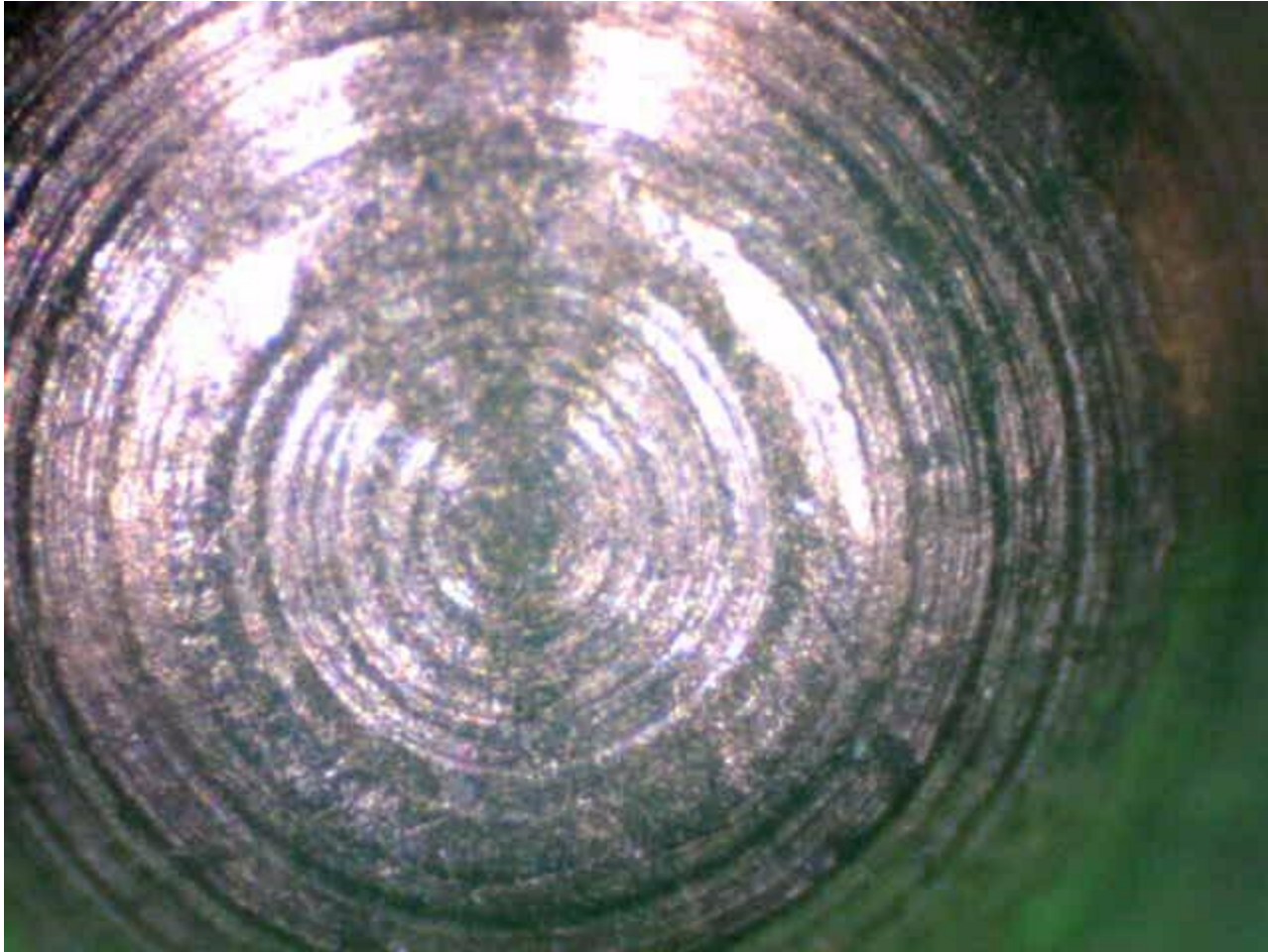

Those Rings "Polish Away" With

Use²⁵⁰ Uses



Those Rings "Polish Away" With

Use ^e 1500 Uses



Those Rings "Polish Away" With

Use
5000 Uses



The Plug Picks Up Marks From Driver Pins 250 Uses

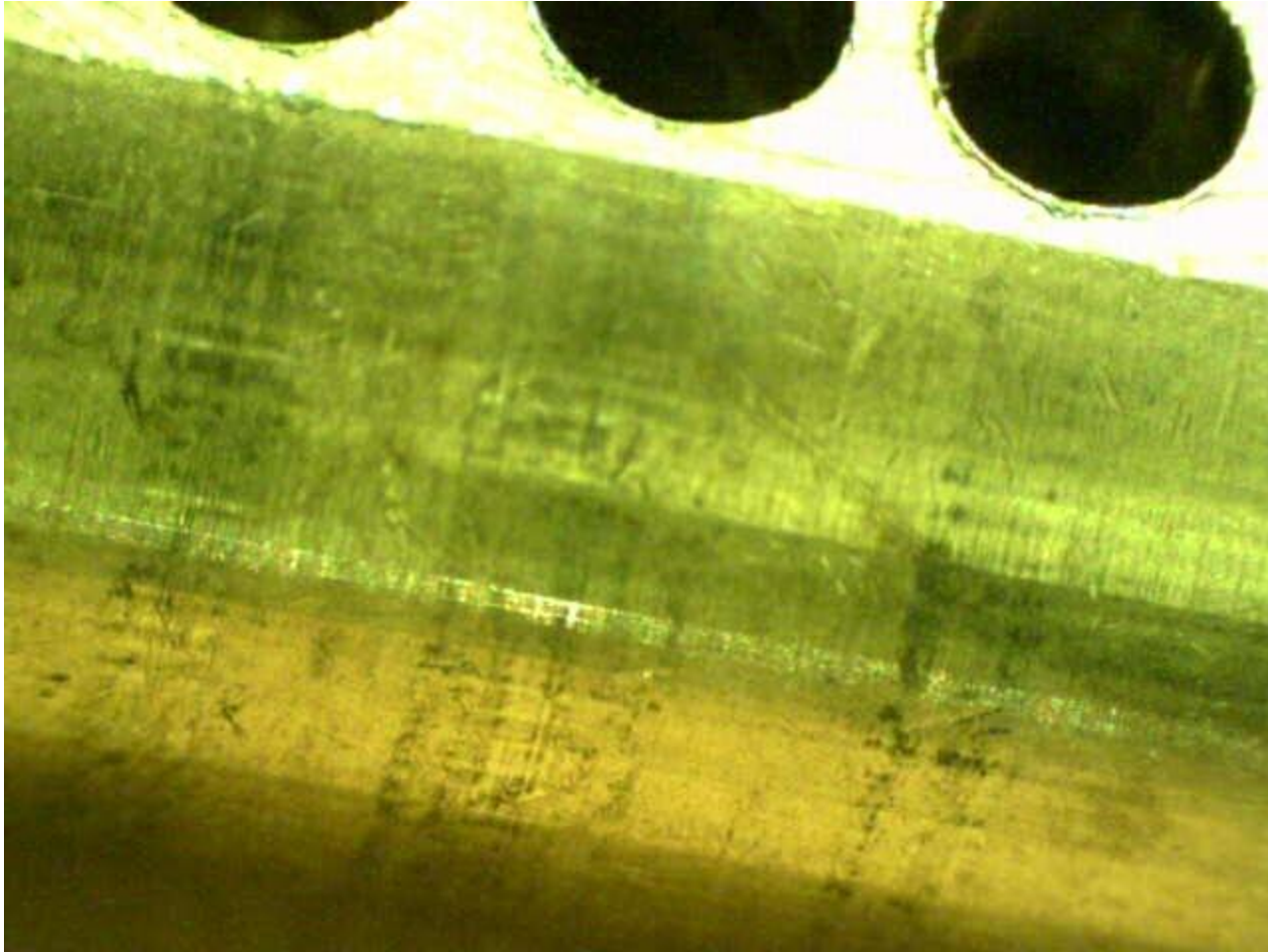

The Plug Picks Up Marks From

Driver Pins 1500 Uses

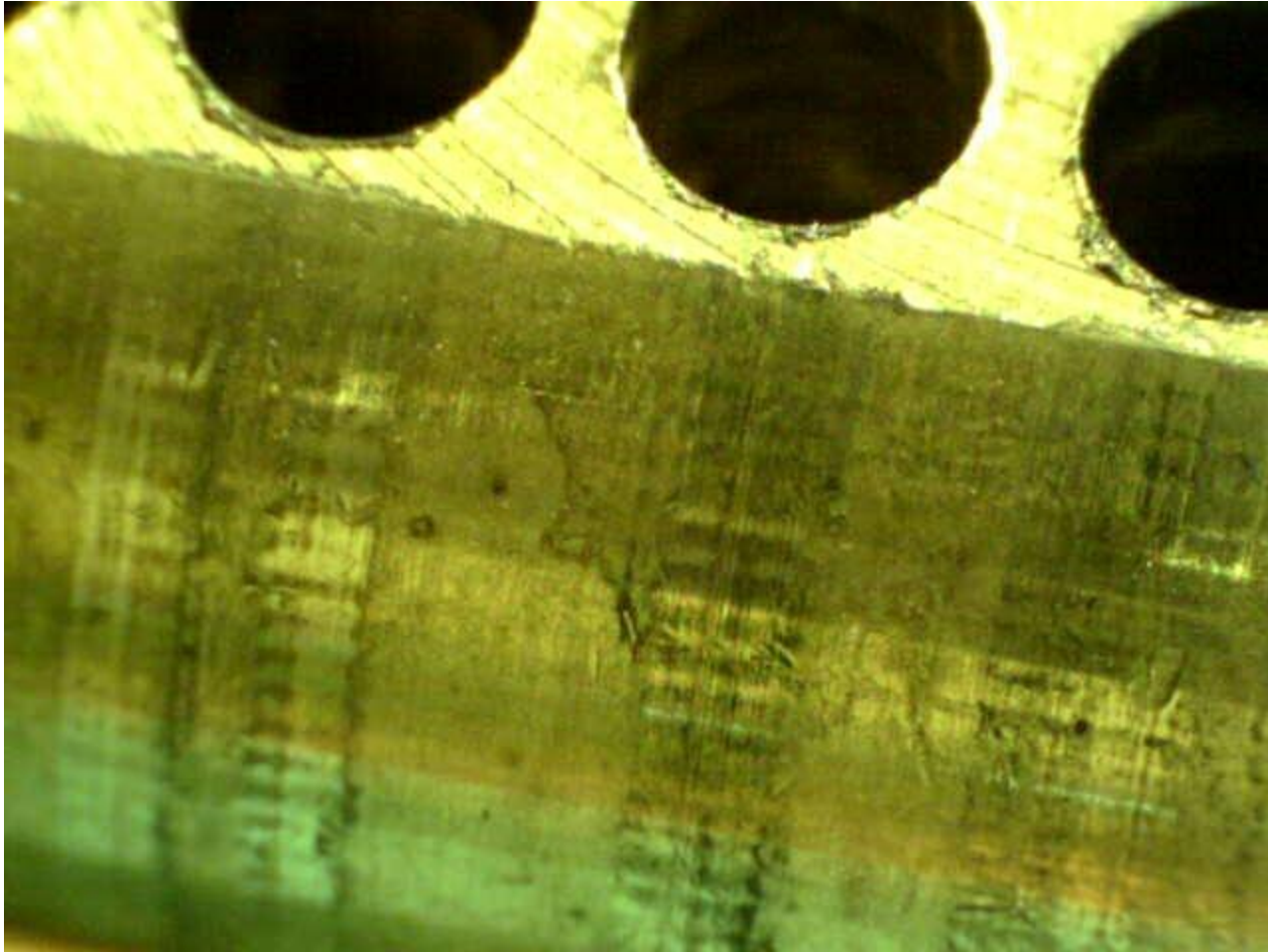

The Plug Picks Up Marks From Driver Pins 5000 Uses

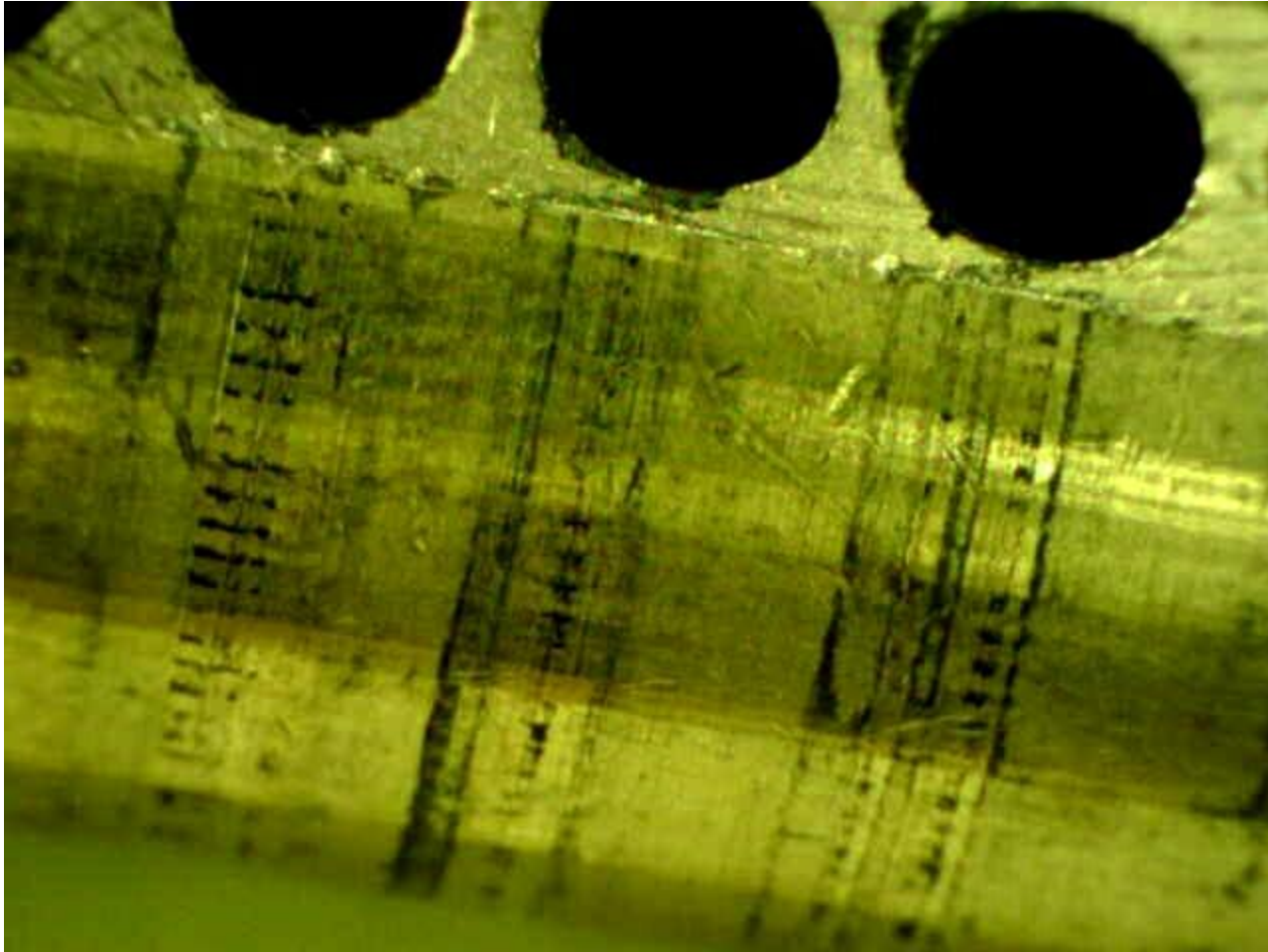

Picks Touch Places That Keys

Don't

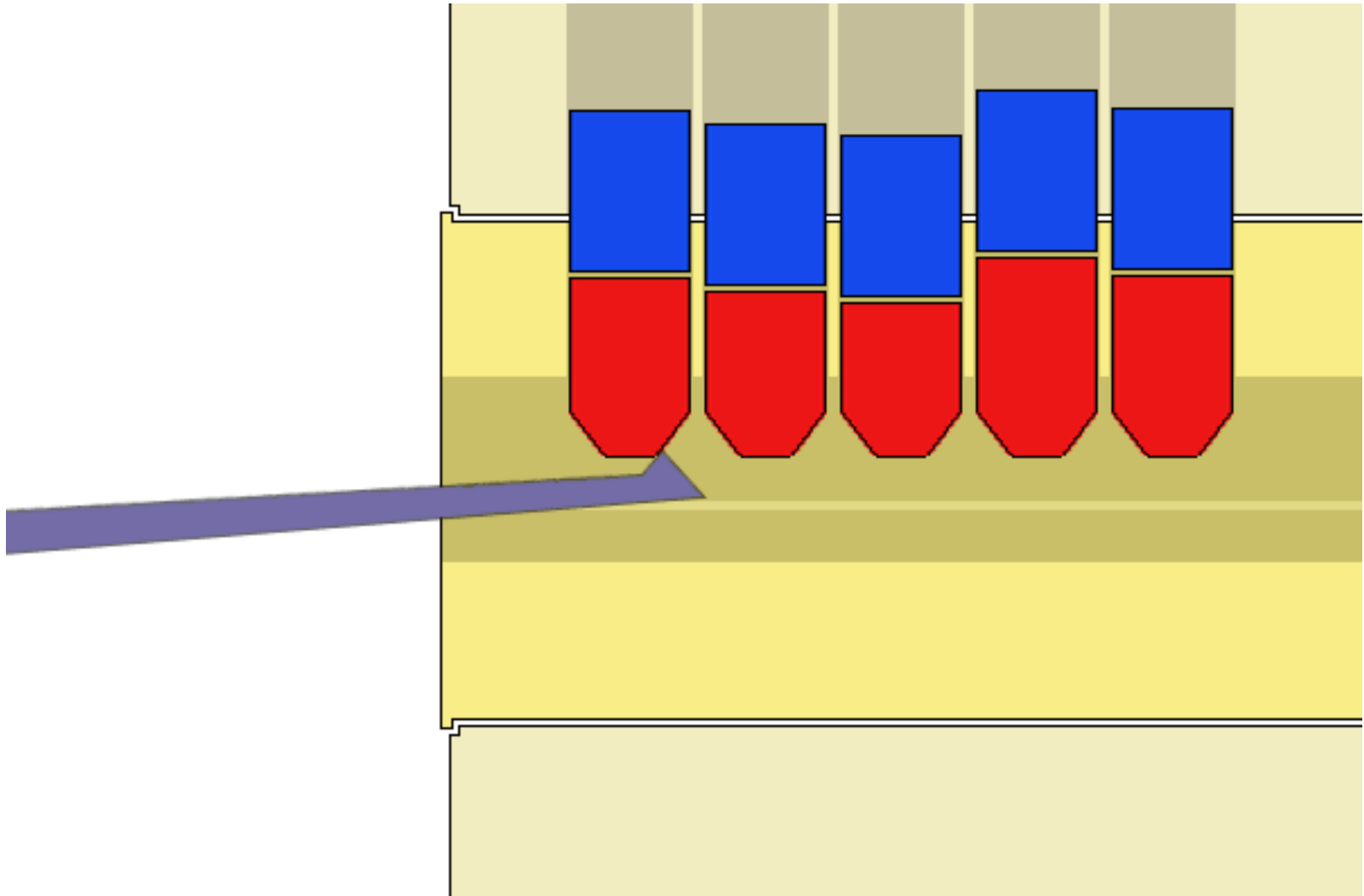

Wear and Tear or Toolmarks ?



Wear and Tear or Toolmarks ?

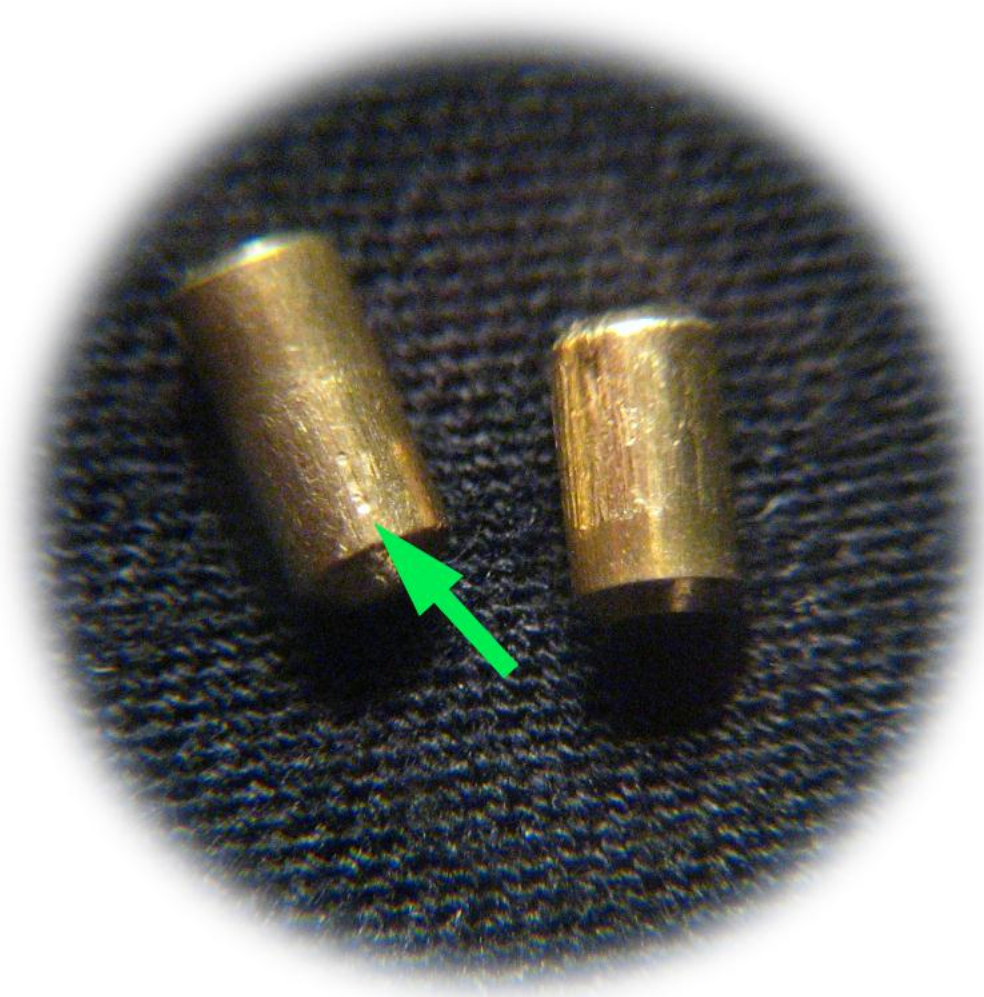

Wear and Tear or Toolmarks ?

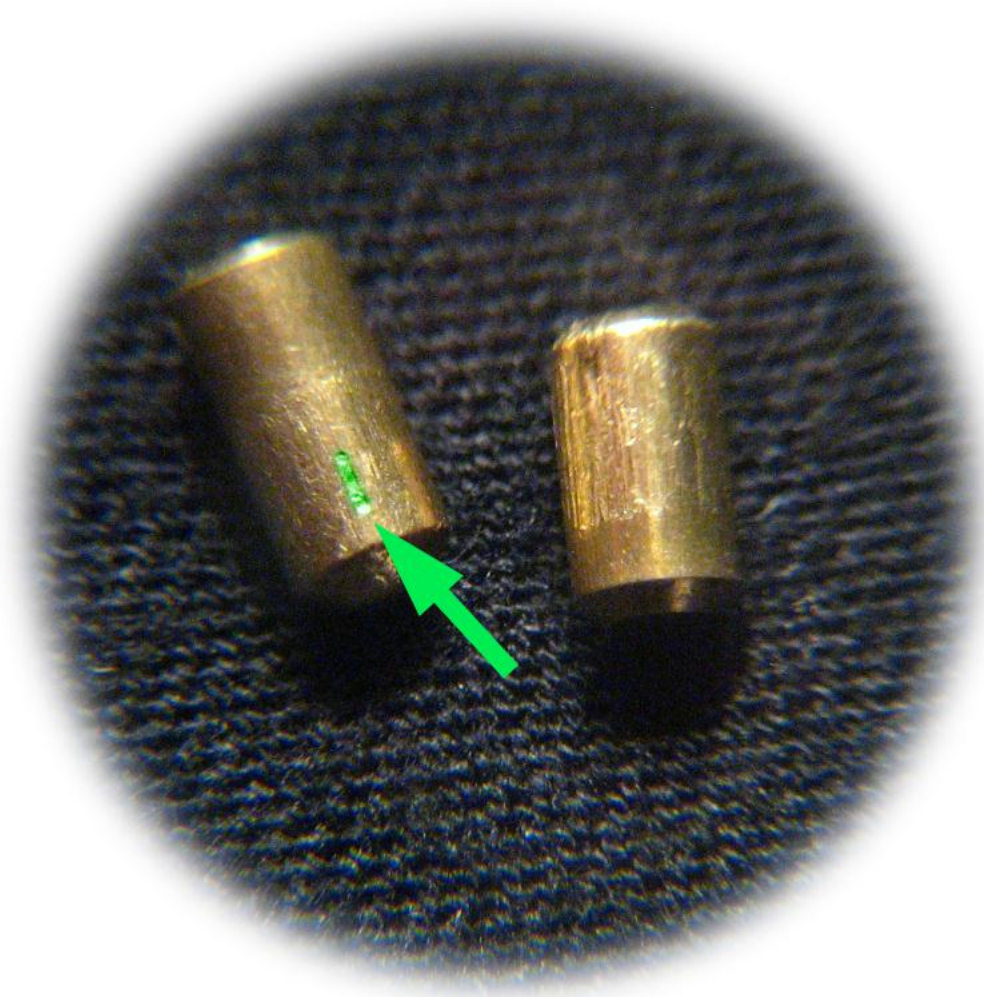

Wear and Tear or Toolmarks ?



Forensics - Lifting Picking



Forensics - Raking

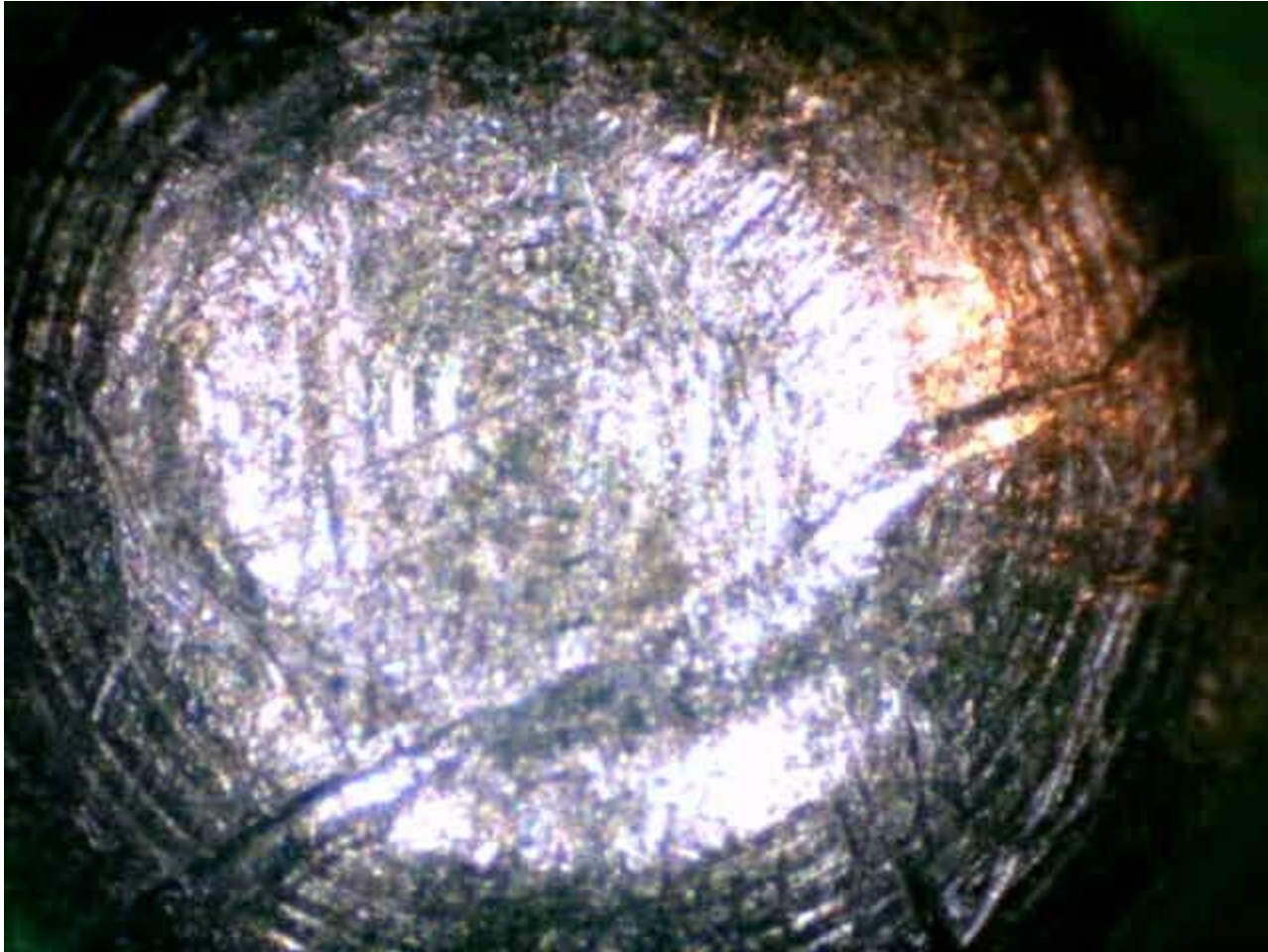

Forensics - Mixed Styles of Picking



Forensics - Ugh... Who Did This ??



Forensics - Even Skilled Pickers and Soft Touches Leave Marks



Forensics of Snapper Guns

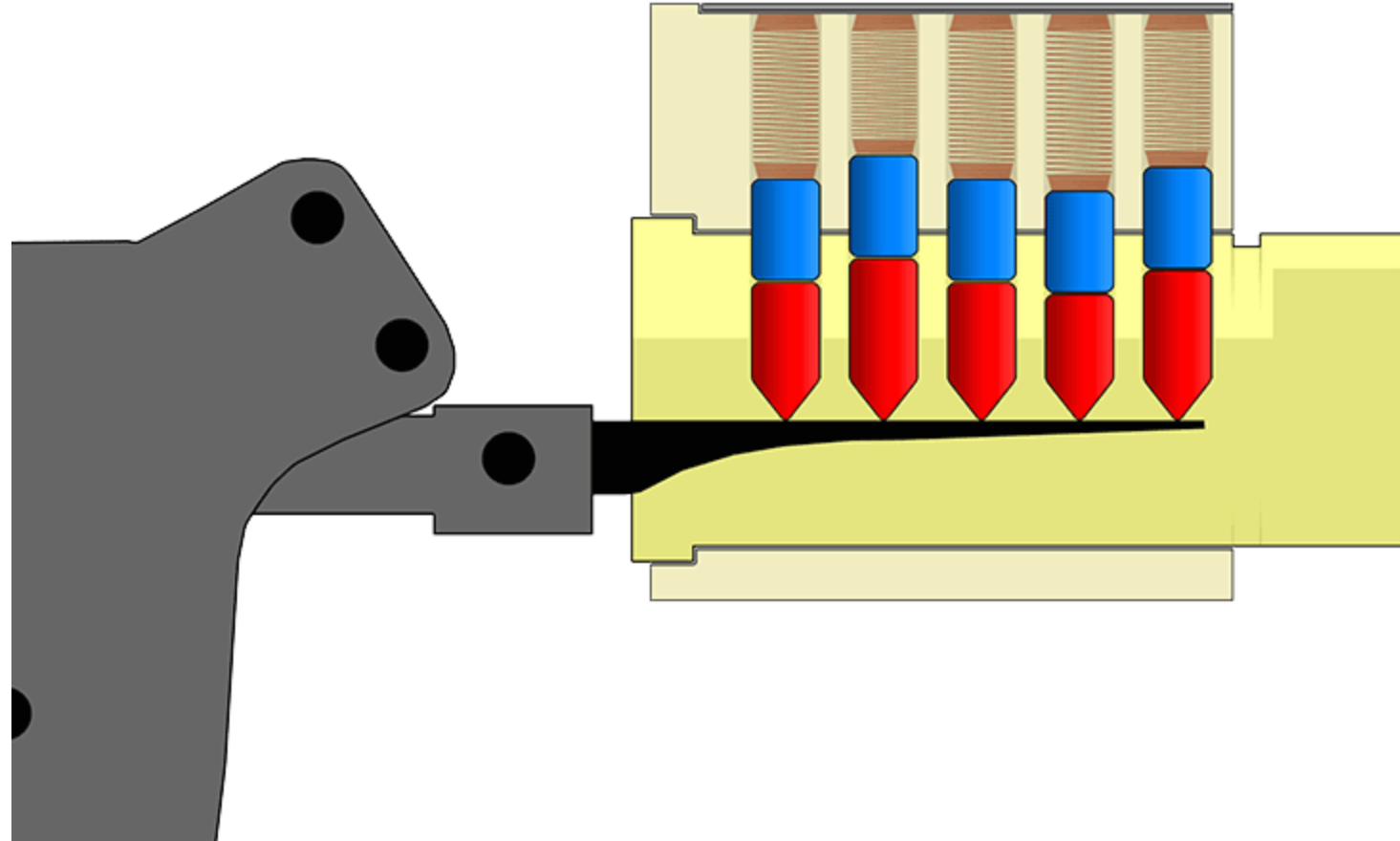

Repeated Snap Marks



Some People Poke Too Deep

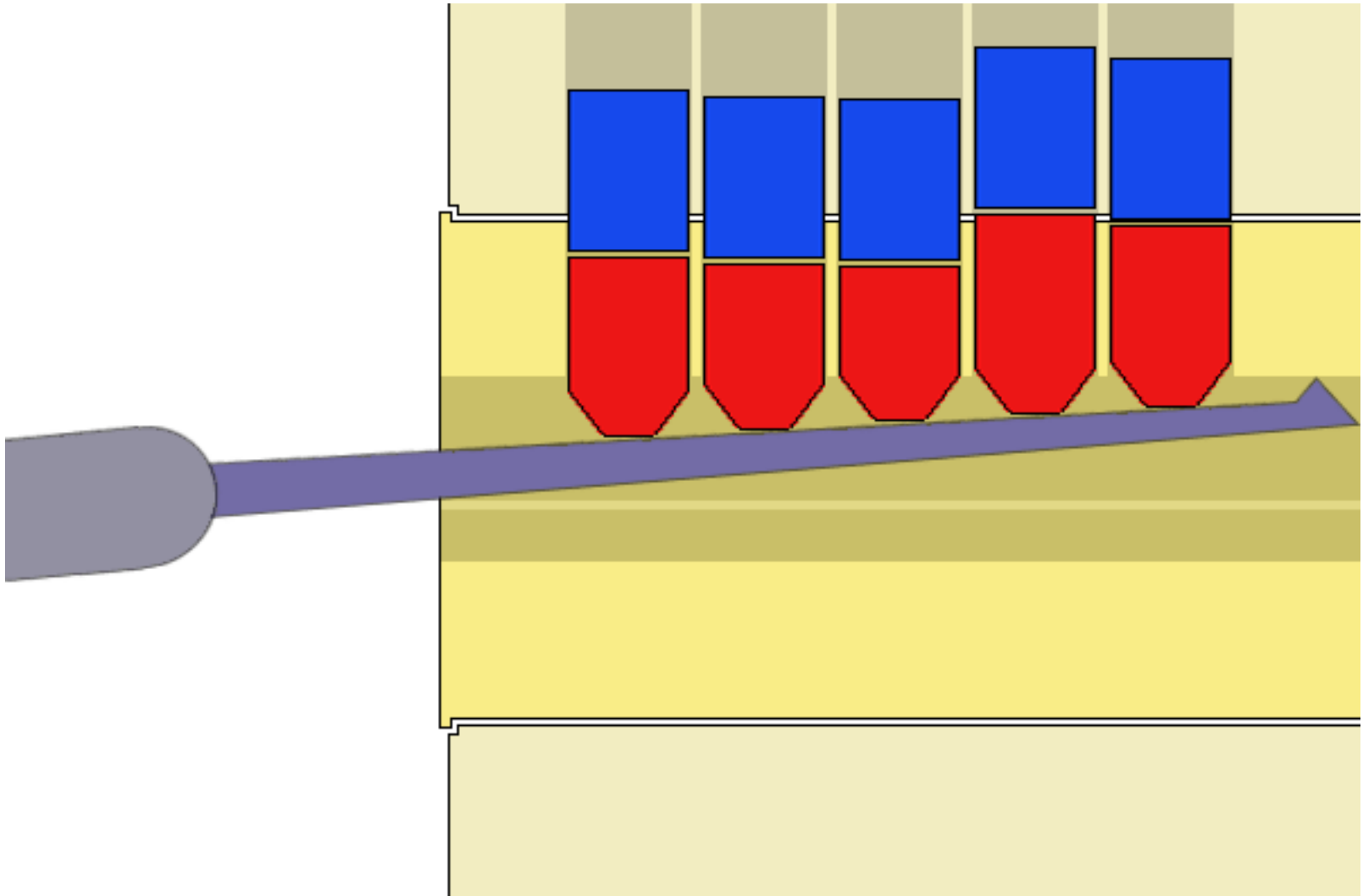

Tools Too Deep - Marks in Rear Top of Keyway

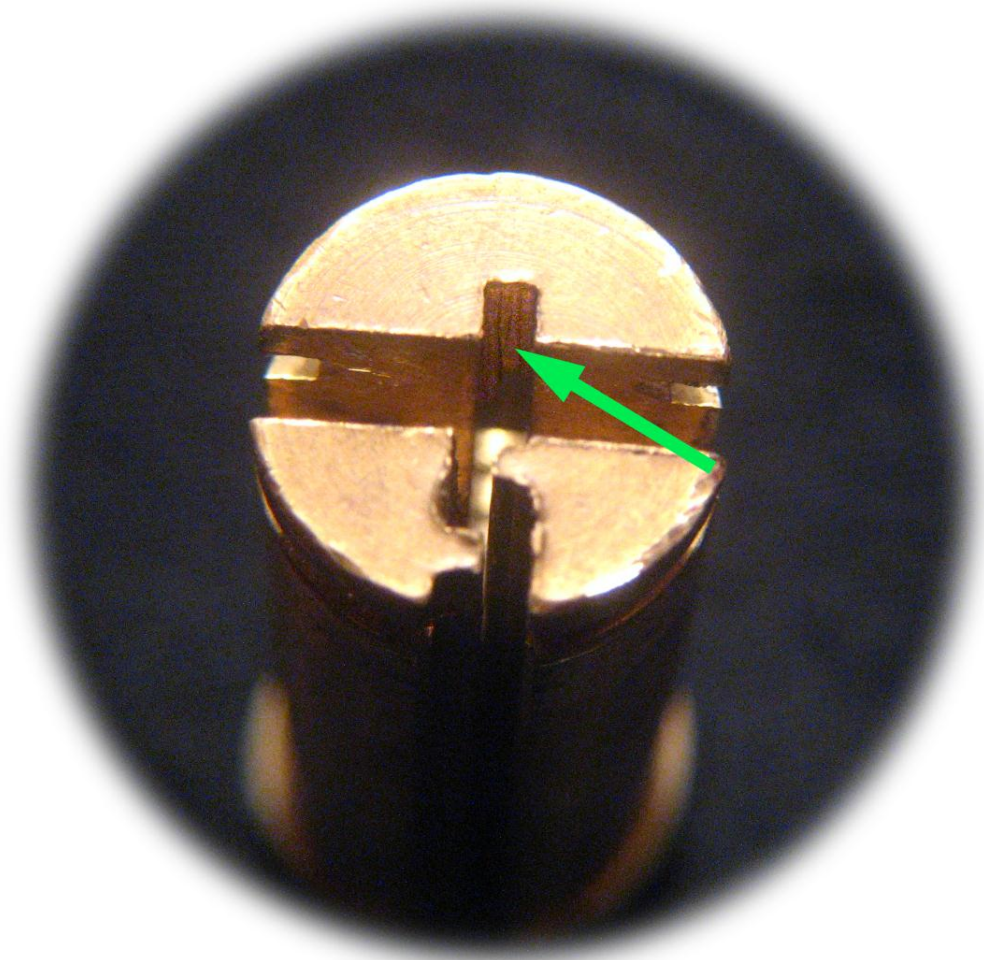

Tools in Too Deep - Marks on Tail Cap

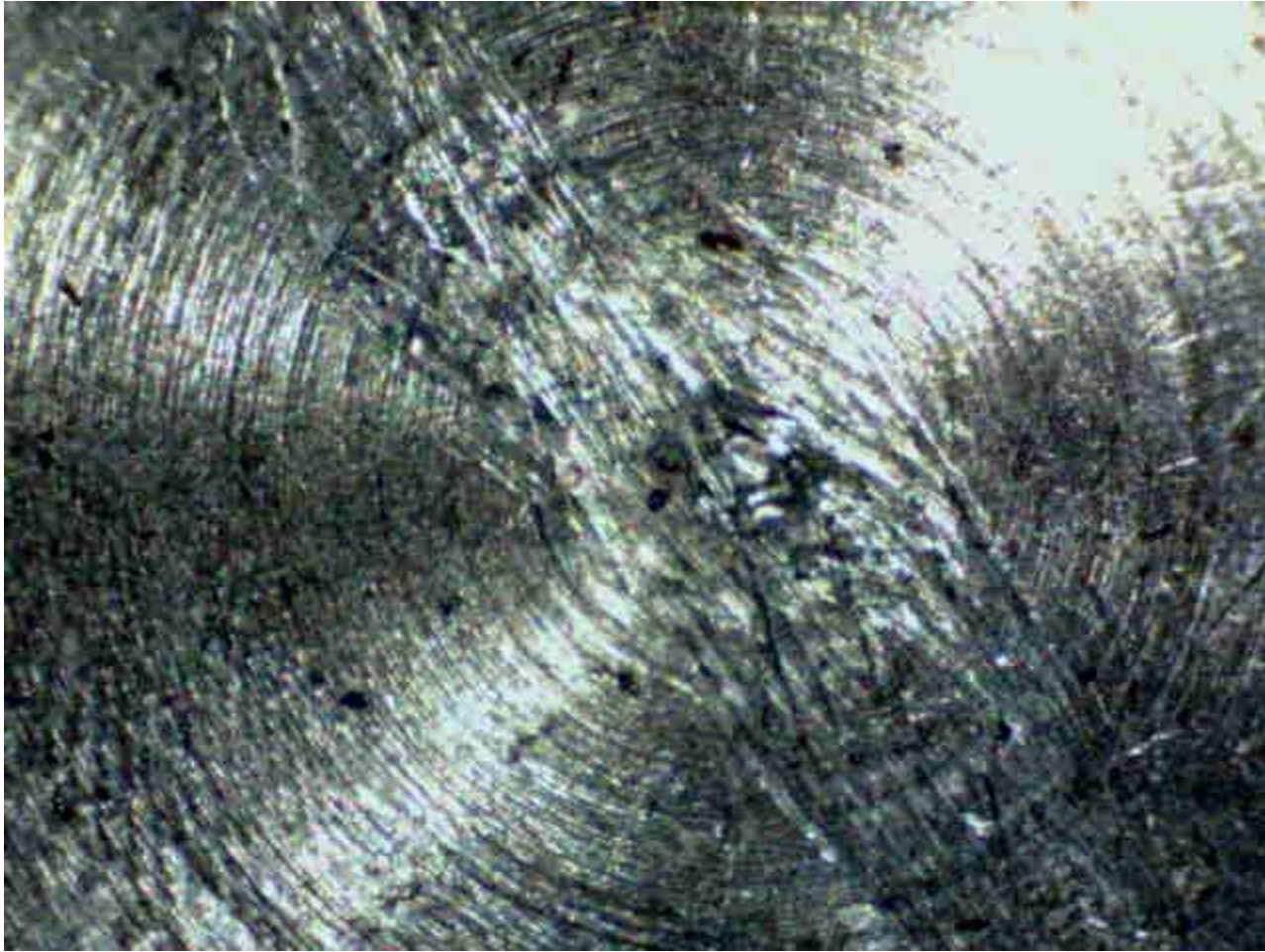

Tension Tools in the Keyway



Tension Tools can "Pinch" the Keyway

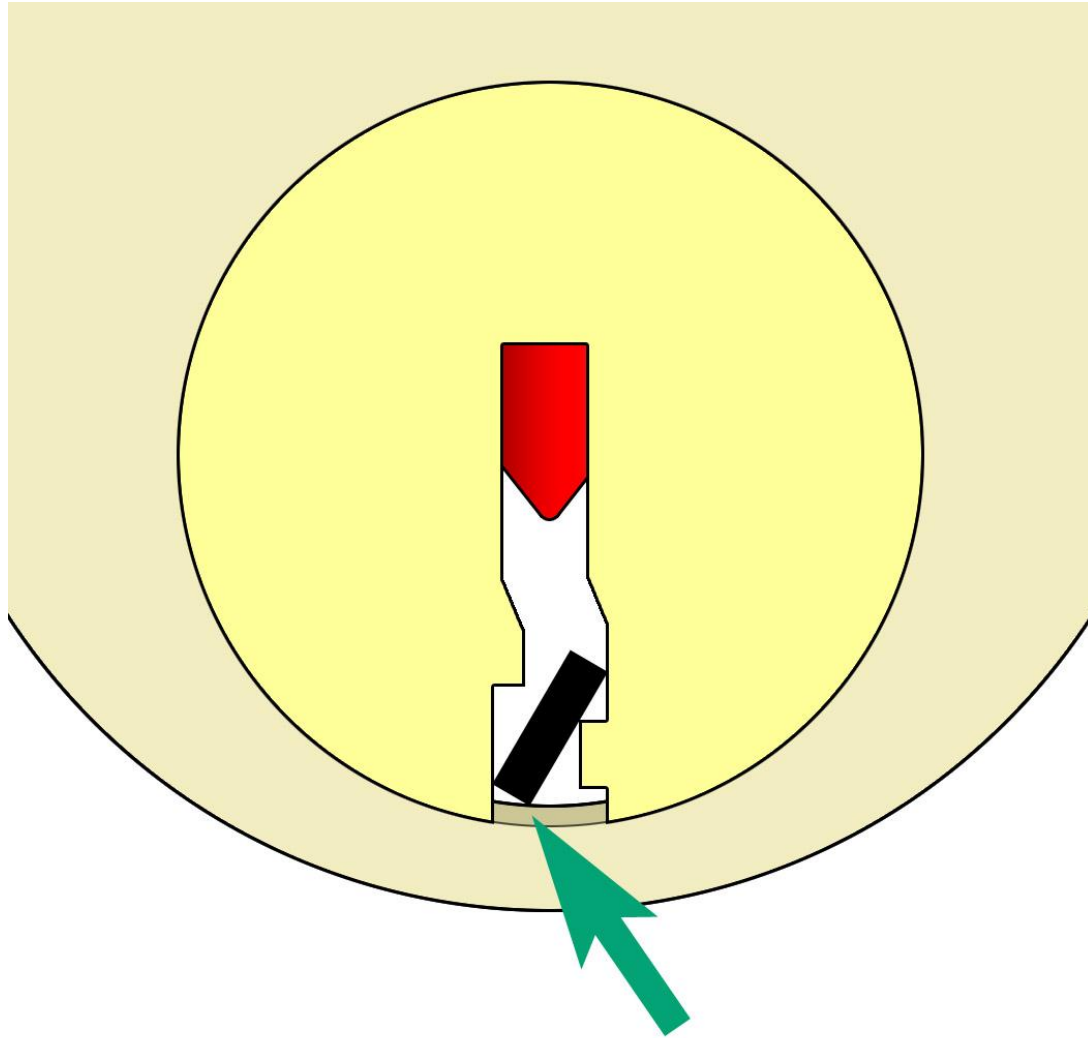

Tension Tools can "Pinch" the Keyway

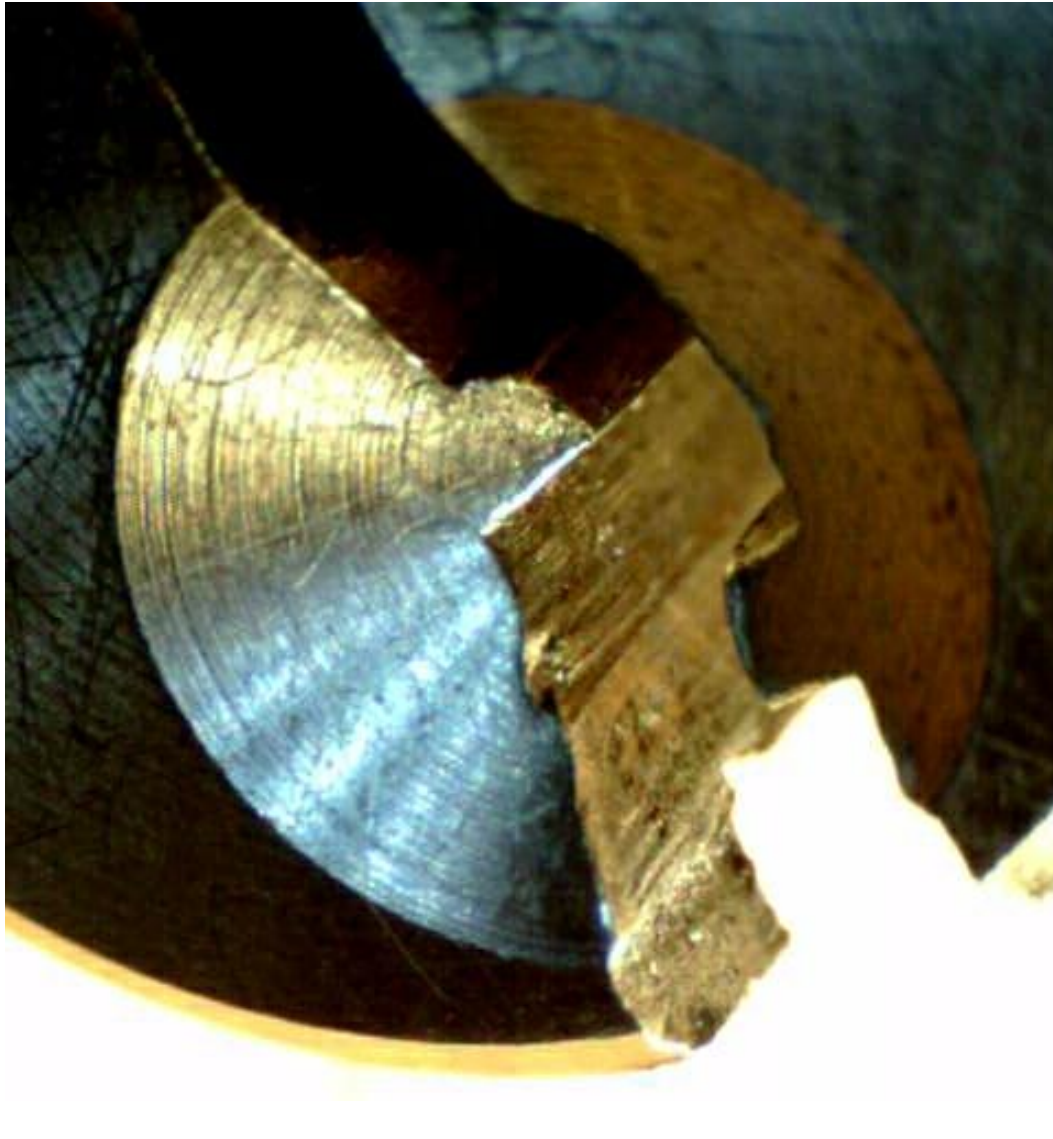

Fraudulent Toolmarks



Fraudulent Toolmarks



Bump Key Forensics

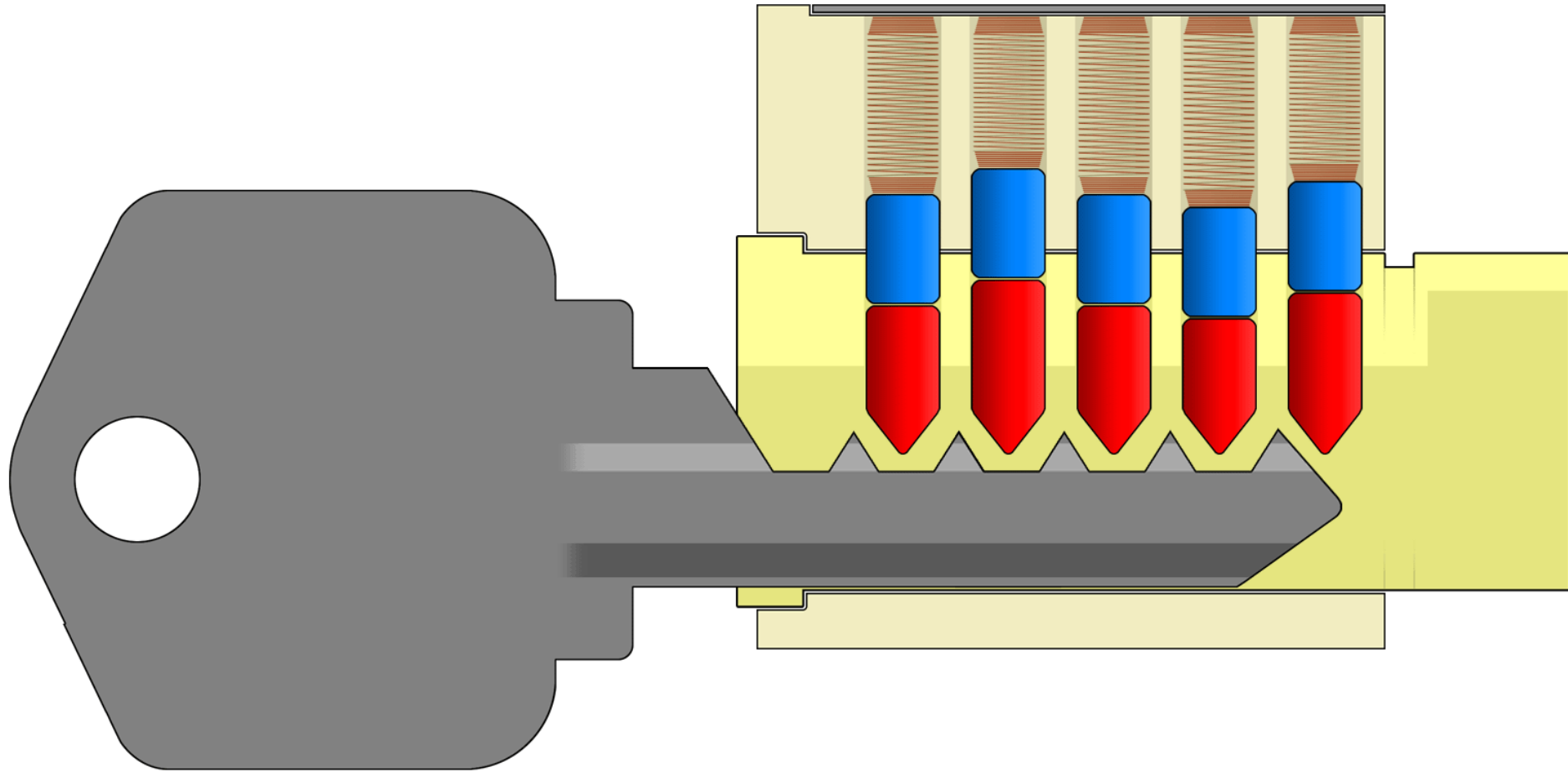

Bump Key Forensics

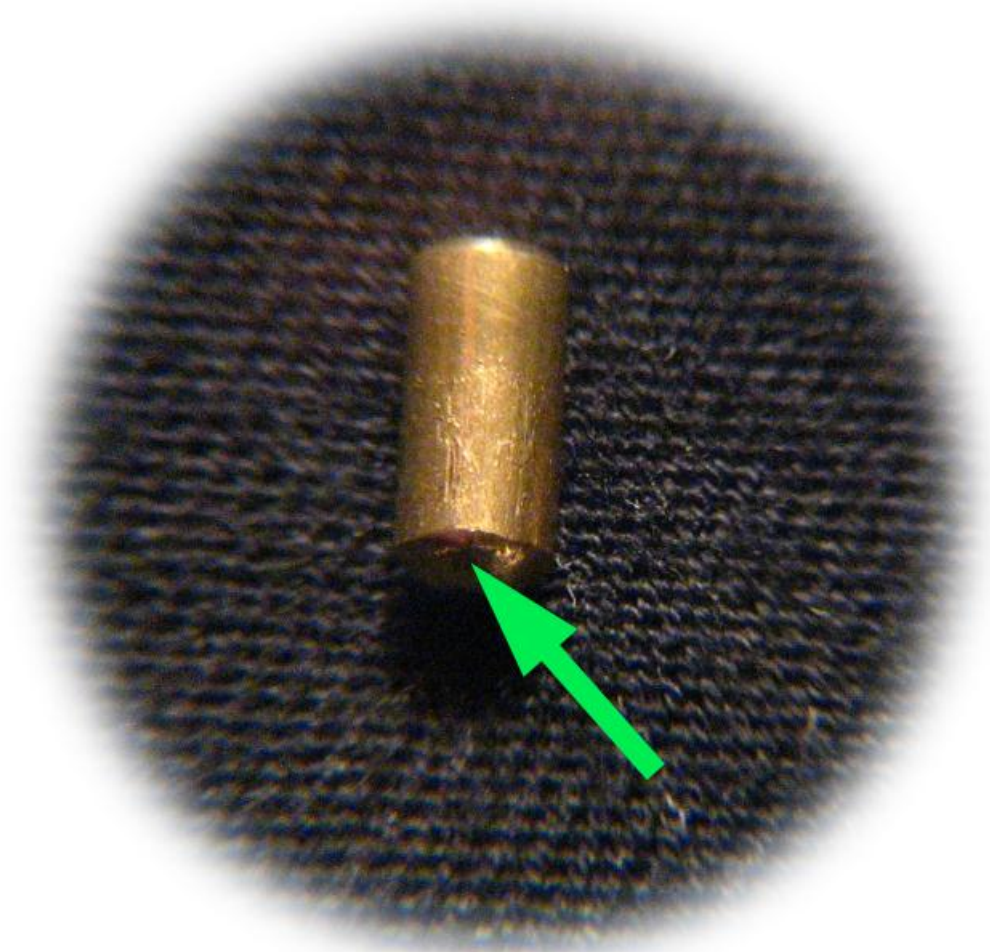

Bump Key Forensics

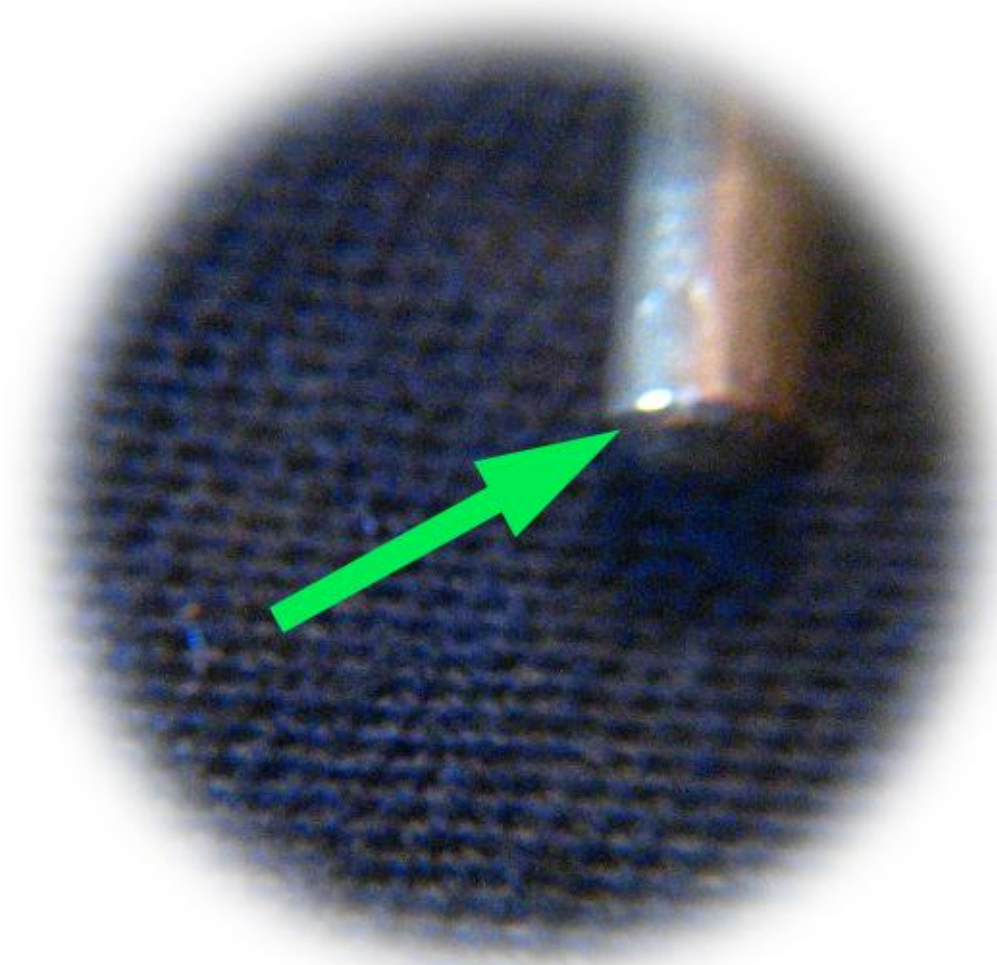

Bump Key Forensics



Bump Key Forensics



Questions?

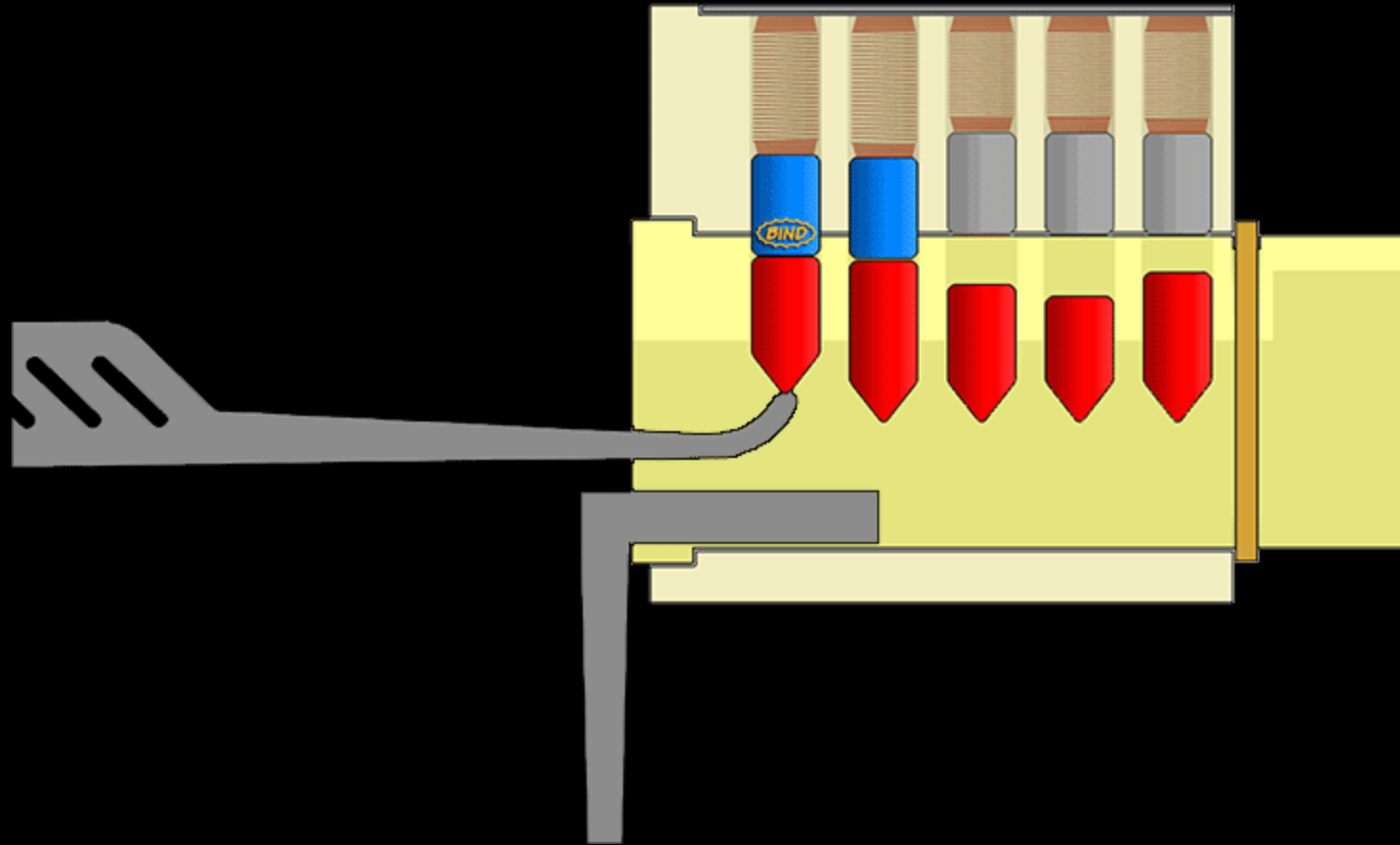

Resources for Learning More

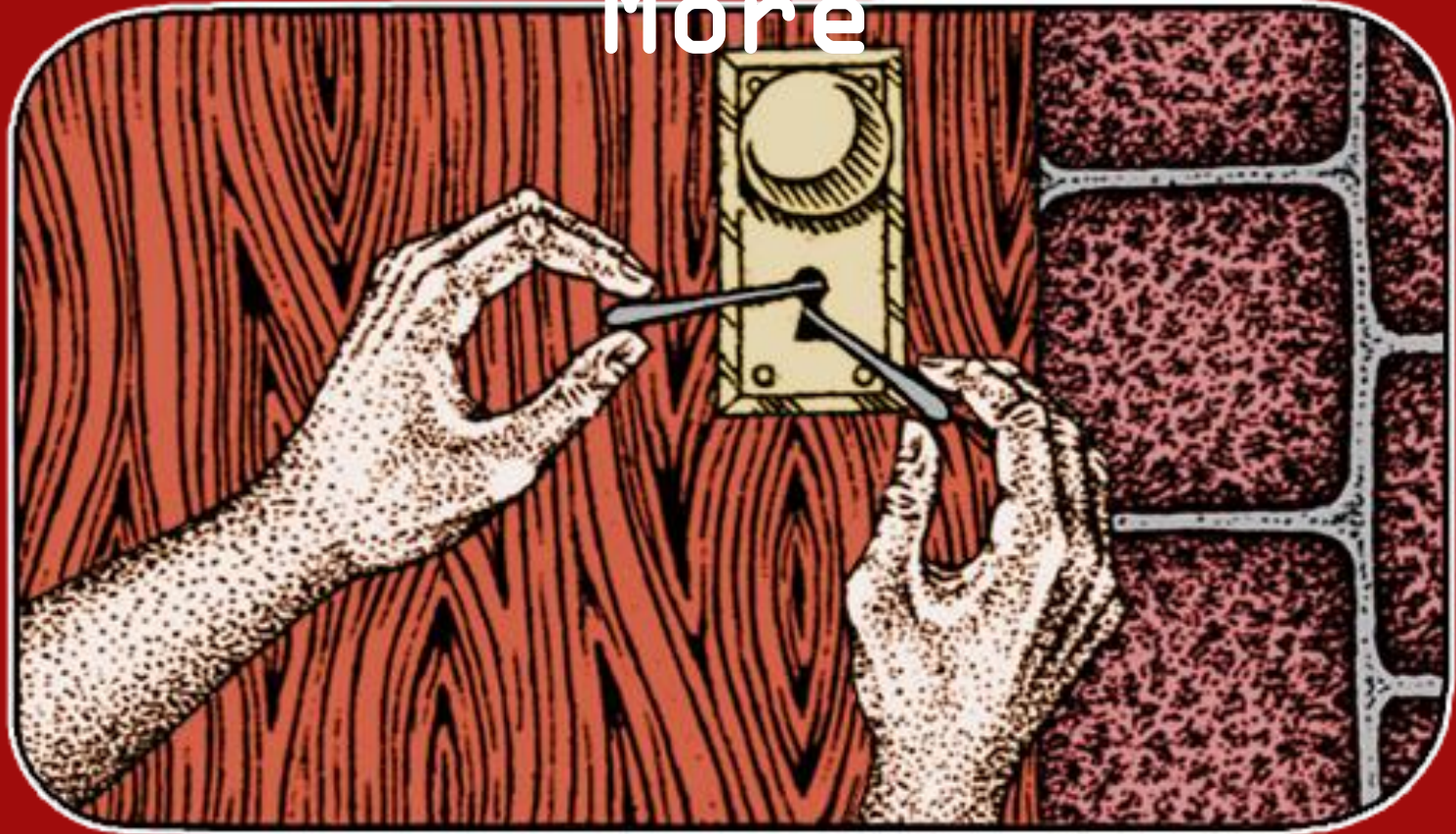

Resources For Learning More

- Books

- *Practical Lock Picking & other books* by D. Ollam
- *High Security Mechanical Locks* by Graham Palford
- *Locks, Safes, & Security* by Marc T. Weber

- Videos

- [YouTube](#) & [Google](#)
- <http://connect.waag.org/toool>
- <http://deviating.net/lockpicking/videos.html>

- On The Web

- <http://tool.us>
- <http://toool.us>
- <http://blackbag.nl>
- <http://deviating.net>

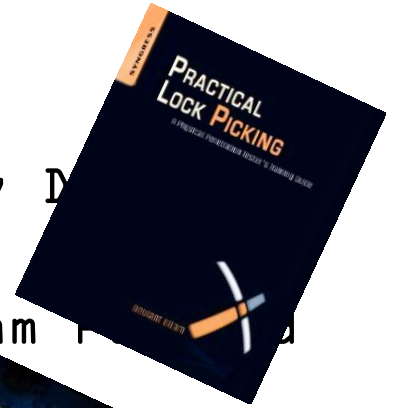

Resources For Learning More



Legal Questions

- We are not lawyers
- Purchase/Shipping through mail
 - Lock manufacturer
 - Auto dealer
 - Law enforcement
 - Repo man
 - Bona fide locksmith
- Possession & use
 - Burglary tools statutes
 - During an illegal act



Acquiring Locks

- Free

- Basements, garages, yard sales
- Ask neighbors, ask locksmiths



- For sale

- Vary your sources
- Hardware store vs. eBay



- Specialized

- Progressive kits
- Ultimate practice lock



Security in the Real World

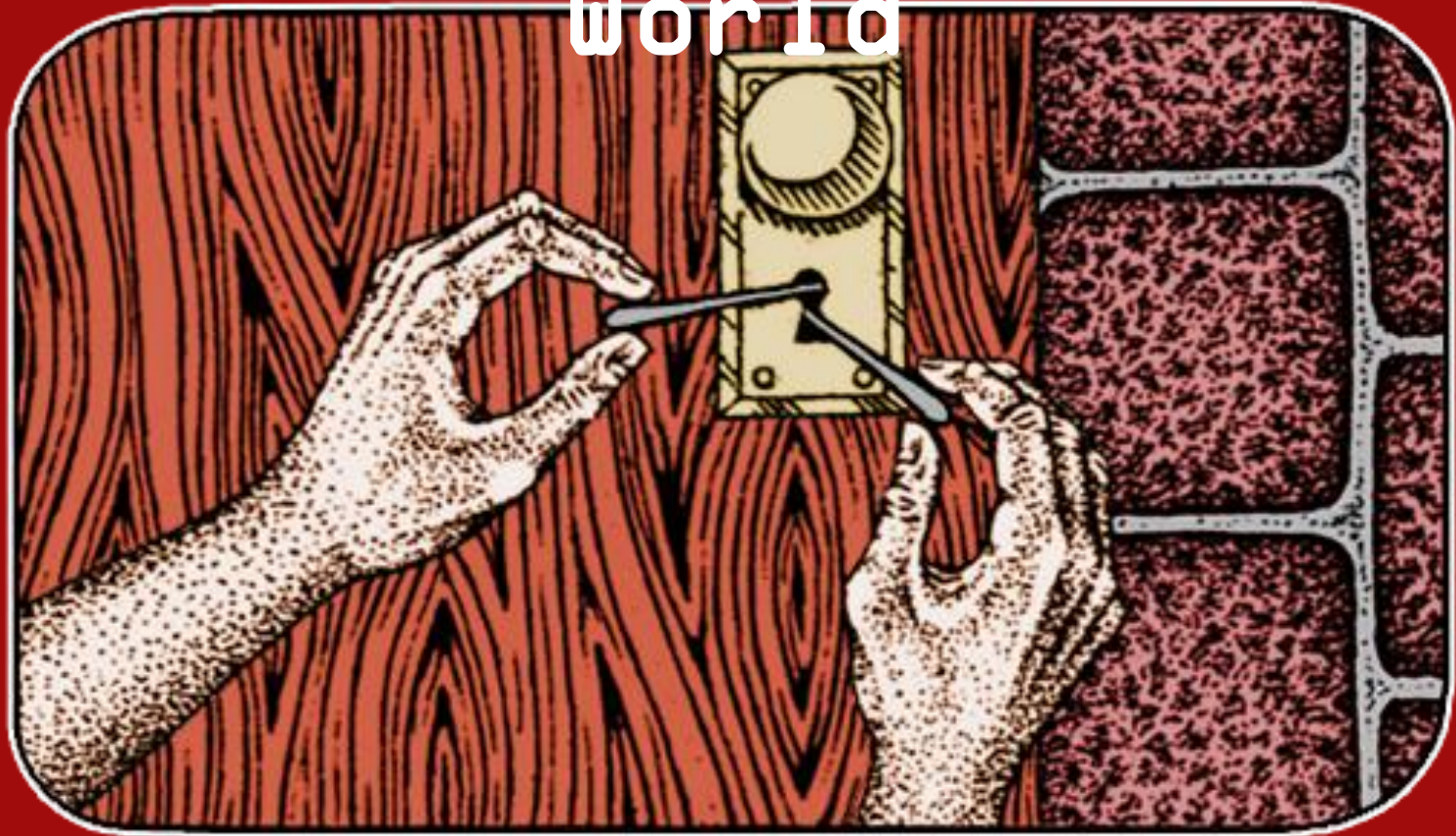

Security in the Real World

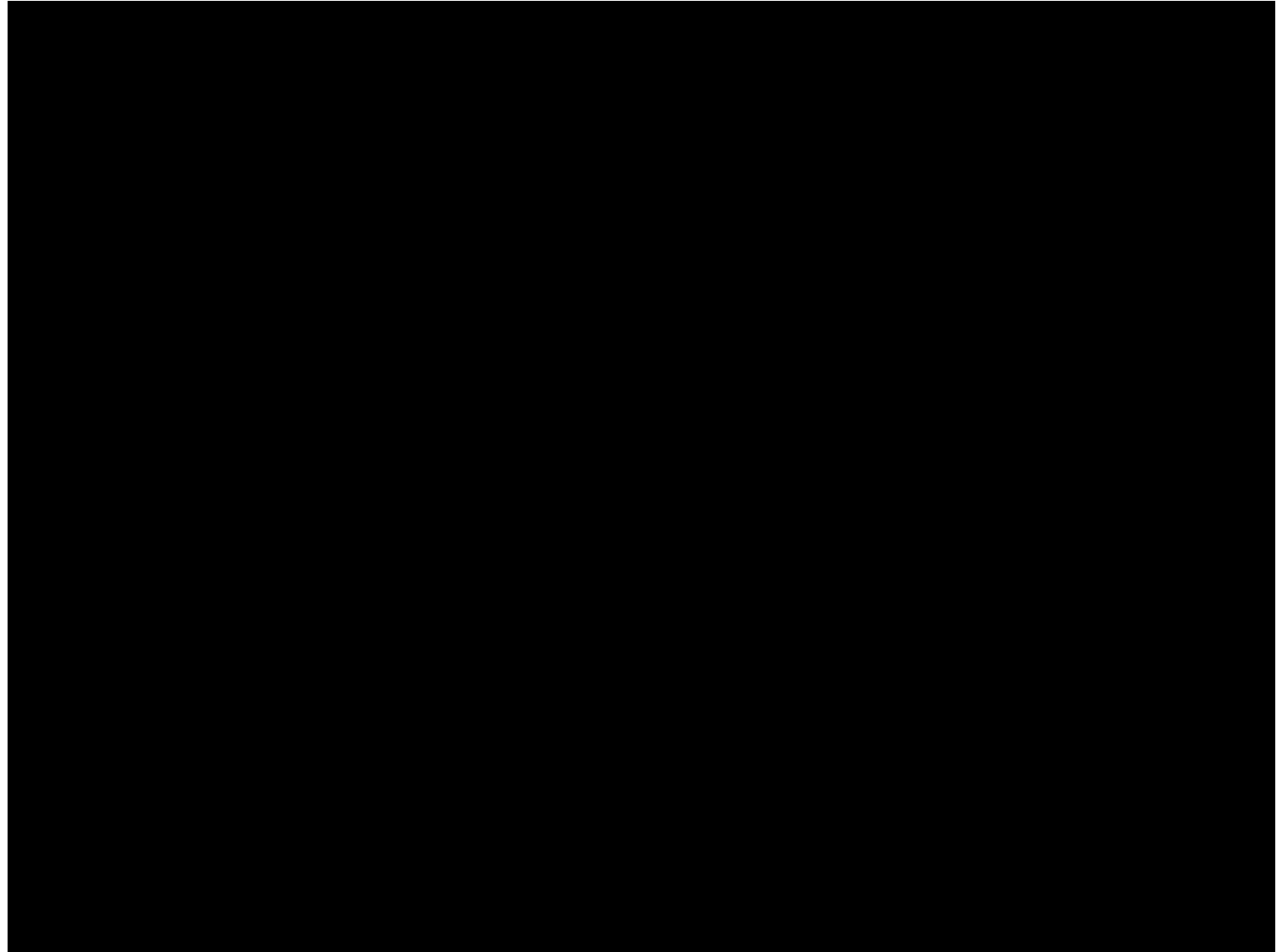

Security in the Real World

- Technical Finesse or
 - \$100 lock in a \$10 door
- Doors
 - Solid core, heavy hinge
 - Anti-thrust bolts and
- Windows
 - Shatterproof film
 - Vulnerable to lifting?
(glass)



Security in the Real World

Lockpicking

Quick & Dirty ← *guard*
against these attacks

Covert & High-Tech

What People Think About Lockpickers...

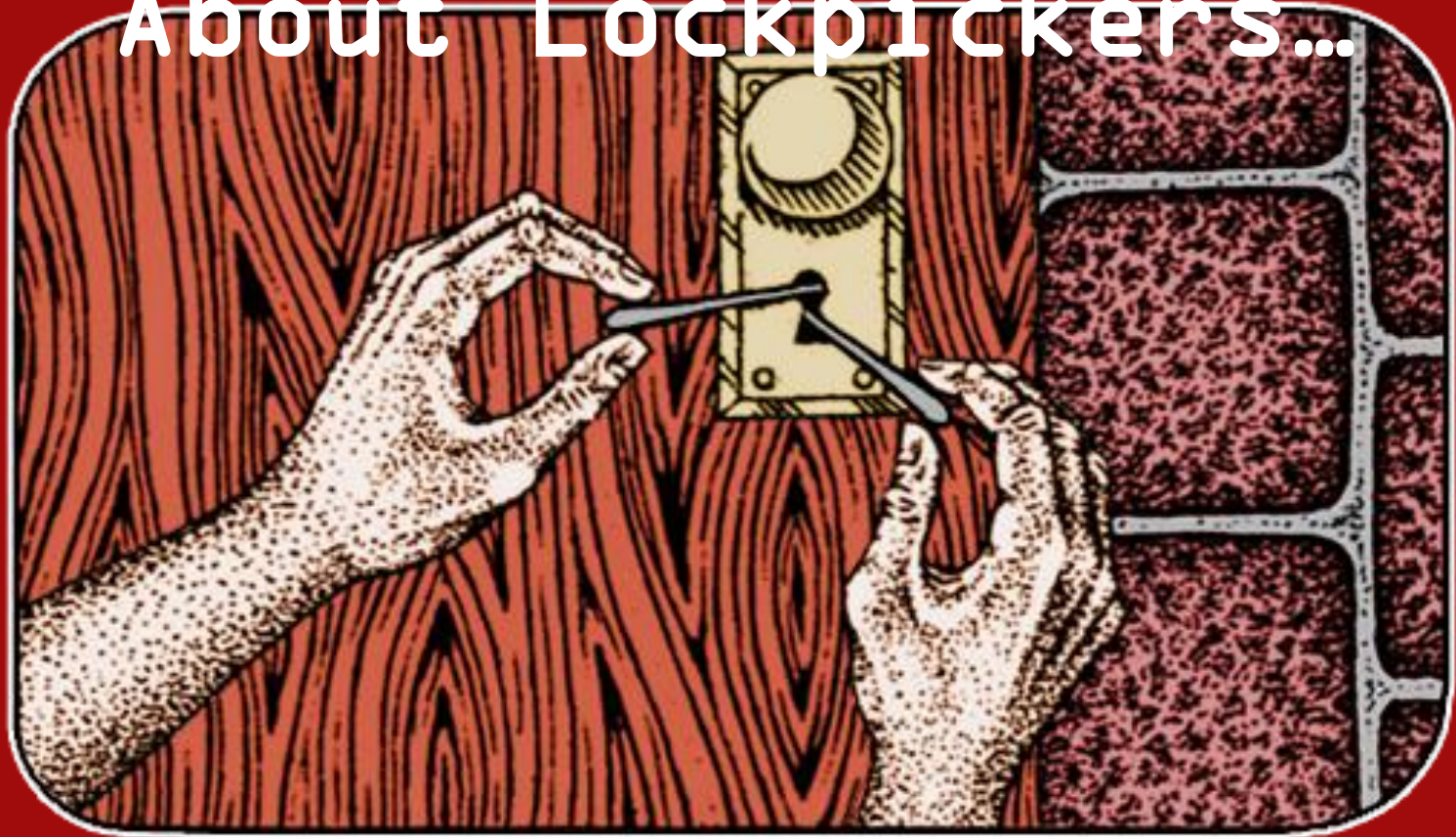

Some People Think We Are Shady...



...But We Are Regular Folks



Young and Old...



...Men and Women



We Like Working With Our Hands...



...And Learning New Things



It's Healthy Competition



Where The Fastest Time Wins



Thank You For Listening



Thank You Very Much



<http://toool.us>

info@toool.us



This presentation is CopyLeft by Deviant 0llam.
You are free to reuse any or all of this material as long as it is attributed